

TOOLS THAT MAKE THEIR MARK.



TOOL CATALOGUE 2024

K-W24/EN/XX/0

Errors excepted

EINFACH VIGOR.



TecAlliance

Data Supplier



EINFACH VIGOR.

	Tool trolleys and factory equipment	→ 26–89
	Tool storage	→ 90–119
	Hand tools	→ 120–227
	Torque tools	→ 228–229
	Pneumatic tools	→ 230–237
	General workshop tools	→ 238–250
	Diagnostics / Battery / Electrical System	→ 251–257
	Engine / Radiator / A/C	→ 258–270
	Oil service	→ 271–276
	Brakes	→ 277–294
	Wheels / tyres	→ 295–306
	Body	→ 307–314
	Motor / commercial vehicle chassis specialty tools	→ 315–319

Table of contents



Tool trolleys with assortment	29–45	Service trolley	57
Mobile work bench with assortment	46–47	Accessories for tool trolleys	58–65
Tool trolleys without assortment	48–53, 56	Storage system	67–78
Mobile work bench without assortment	54–55	Accessories for storage system	79–89
<hr/>			
Multiboxes	92–93		
Soft foam inserts	94–119		
<hr/>			
Sockets	122–175	VDE tools	209–212
Universal tool cases	176–177	Impact and loosening tools, scrapers	213–220
Wrenches	178–185	Various hand tools	220–221
Screwdrivers and bits	186–198	Cutting and sawing	221–227
Pliers	199–208		
<hr/>			
Torque wrenches	229		
Rotation angle tester	229		
<hr/>			
Impact wrenches	231–232		
Air ratchets	233		
Die grinder	234		
Pneumatic air blow and body protection guns	235, 237		
Hose reel	236		
<hr/>			
Video borescope	252		
Flue gas leakage tester	253		
Electrical system	254		
Multimeter	256–257		
Cable release tools	254		
Crimping pliers set	255		
	256		
<hr/>			
Engine tools	259–262		
Cooling system diagnostics	263–265		
Turbo system diagnostics	266–267		
Compression and pressure loss testers	268		
Vacuum and pressure pump set	269		
Injector sealing seat cleaning	270		
<hr/>			
Oil dipsticks	272		
Oil filter tensioner adjusters	273–274		
Oil pumps and filling devices	275–276		
<hr/>			
Brake maintenance and bleeding	278–280		
Brake piston readjusting tools	281–284		
Brake disc tools	285–286		
Tube flaring tools	287–289		
Inspection tools	290–294		
<hr/>			
Impact sockets	296–298		
Service jacks and jack stands	299–302		
Wheel / tyre tools	303–306		
<hr/>			
Wiper arm puller set	308		
Repair and installation sets	309		
Induction heater and accessories	310–314		
<hr/>			
Motor vehicles chassis – Various	315–319		



Description of drive symbols

	For slotted screws
	For Phillips-Recess screws (PH)
	For Pozidriv screws (PZ)
	For inside hexagon screws
	For outside hexagon screws
	For inside hexalobular screws
	For tamper resistant hexalobular screws (inside hexalobular screws with pin)
	For outside hexalobular screws
	For screws with internal serration XZN
	For spline socket screws
	For Polydrive screws
	For inside 5-star screws with centre pin
	For Tri-Wing® screws
	Nominal size 6.3 mm
	Nominal size 10 mm
	Nominal size 12.5 mm
	Nominal size 20 mm
	Nominal size 25 mm
	Inside square
	Outside square
	Inside hexagon
	Outside hexagon
	EN/IEC 60900:2004

Description of icons

	Tools for motor vehicles
	Tools for trucks
	Operating instructions/Application note
	Central locking
	Weight of tool trolley
	Loading capacity of tool trolley
	Number of pieces
	Teeth
	Rotation angle
	Bore holes
	Shafts
	Magnet
	Operating time
	Charging time
	Weight
	Battery type
	Audible signal
	Working pressure
	Vibration
	rpm
	Sound level
	Max. loosening torque
	Twin hammer mechanism
	Coupler plug, nominal size
	Battery type
	Test equipment
	SUV/Van
	Agricultural machinery
	Industry
	QR Code
	Application video
	Hose length
	Oil capacity
	Hydraulic working
	Mechanical working

Alphabetical index of key words



A

Adapter / connection piece.....	131, 142–143, 164, 167, 170, 267, 279
Air blow gun.....	235–236
Air ratchet / air-operated power wrench.....	233, 297–298
Assembly trolley.....	29–31, 33–40, 42–44, 48–53, 55–60, 62–65
Assortment / set.....	95–109, 116–118, 122–124, 133, 144, 149, 167–175, 183, 187–189, 191–193, 201, 203, 209, 211, 215, 217–220, 225, 240–242, 247, 256, 259, 261–262, 264, 266–267, 270, 272, 276, 278, 280, 288–289, 294, 297–298, 301–303, 308–309, 315

B

Balance weight pliers.....	303
Balance weight tool.....	303, 305
Bits and screwdrivers.....	99, 104, 107–109, 117, 125, 128–129, 131, 137–141, 143, 145–148, 158–164, 186–193, 196–198, 210–211
Bottle jack.....	301
Box-end wrench.....	98, 180–184
Brush.....	215, 217, 225–227, 247

C

Cable release tools.....	255
Can holder.....	60
Cape chisel.....	214, 216
Car body tools.....	308–309, 311–314
Car light tester.....	254, 256
Cardan shaft puller.....	317
Carpet knife.....	222–223
Case.....	92–93, 171, 176–177
Centre punch.....	214, 216
Chassis tool.....	288, 291, 296–297, 303–306, 315, 317–319
Chisel.....	100, 104, 117–118, 214
Circlip pliers.....	102, 200–202, 204, 262
Clamping screw tool.....	315
Club hammer.....	213
Combination pliers.....	199, 207, 212
Combination spanner.....	97, 108–109, 117
Combination wrench.....	97, 108–109, 112, 117, 179
Compression and engine leakage tester.....	268–269
Connection piece / adapter.....	119, 131, 142–143, 164, 167, 170, 267, 279
Cooling system diagnostics.....	263–264
Corner base cabinet.....	76
Crimping pliers.....	256
Cross recess (PH) tool.....	129, 138, 186, 188, 210
Cutting knife.....	222–223

D

Depth gauge.....	303
Diagnostics.....	211, 220–221, 229, 254, 256, 261, 263–264, 266–269, 272, 286, 291, 303
Diagonal cutter.....	199, 208, 212
Die grinder.....	234
Double box-end wrench.....	98, 180, 182, 184
Double open-end wrench.....	97, 178
Double ratcheting box-end wrench.....	184–185
Double-joint pliers.....	99, 199–200

D

Drawer.....	62
Drawer separation sheet.....	61
Drift pin.....	100, 214, 217
Drift punch.....	100, 214, 217
Drill.....	225
Drive-out pin.....	214, 217

E

Engine leakage / compression tester.....	268–269
Extension.....	130, 142, 164, 168, 210
Extractor socket with spiral profile.....	150, 165

F

Feeler gauge.....	220
File.....	101, 224, 290
Fine tooth ratchet.....	124–125, 135, 154
Finger ratchet.....	125
Fixed castor.....	62
Flat chisel.....	214, 217
Flat wrench.....	108
Flexible / wobble extension.....	130, 142, 164
Flexible handle.....	154
Flexible screwdriver.....	190
Foam mat.....	64
Forceps.....	241

G

Gas torch.....	242
Grinding / Cutting / Machining.....	101, 221–225, 234, 248–249, 290
Grip pliers.....	100, 202–203
Guiding rail.....	63

H

Hammer.....	100, 104, 117–118, 213, 304
Hand riveting tool.....	205–206
Hexagon socket profile tool.....	97, 129, 134, 140–141, 147, 152, 158, 162–163, 210
Hinged-door cabinet.....	75, 77
Holder for paper reel.....	59
Hose clamp pliers.....	204, 262
HSS drill.....	225
Hydraulic service jack.....	299–300

I

Impact wrenches and sockets.....	96, 102–103, 118, 151, 165–166, 168–169, 231–232, 296–298
Induction heater and accessories.....	311–314
Injector sealing seat cleaning.....	270
Inner bearing ring puller.....	319
Inside wedge (Ribe CV) tool.....	104, 147–148, 161

I	
Inspection tool.....	290, 293

J	
Jack stand and service jack.....	299–302
Jack-knife.....	222–223
Japan spatula	240

K	
Kneeling mat	246
Knife / shears.....	221–223, 225

L	
Lambda sensor tool	259
Lock	63
Lubrication / Cleaning / Care	237

M	
Machinist's hammer	213
Magnetic pick-up tool.....	241
Measuring / testing	211, 220–221, 229, 254–256, 261, 263–264, 266–269, 272, 286, 290–291, 293, 303
Mechanic's creeper	93
Mobile work bench.....	46–47, 54–55
Motor vehicle chassis / steering tie rod / shock absorber.....	315
Motor vehicle electrics / electronics	254–256
Motor vehicle wheel bearing tool.....	318–319
Multi-purpose profile tool	124, 128, 149, 157
Multi-Tool	239
Multiboxes	92–93
Multifunctional drain pan.....	242
Multimeter / measuring cable	254

N	
Nut / socket	95–96, 101, 103, 105–107, 116, 122–131, 133–151, 154–175, 192, 209–210, 260, 296–298

O	
Offset screwdriver.....	109, 191
Oil service tools.....	242, 272–276
Open-end wrench.....	97–98, 108–109, 117, 180–181, 183, 185

P	
Perforated plate	84, 88
Phase tester	211
Pick-up tool with claws	241
Plastic cover	63
Pliers	100, 102, 109, 117–118, 199–208, 211–212, 256, 262, 303
Pneumatic tools	96, 102–103, 118, 231–237, 297–298
Pozidriv (PZ) tool.....	129, 138
Pry bar	218–220, 303
Pull-handle	60, 64
Puller / extractor.....	261, 308, 317, 319

R	
Ratchet / ratchet wrench.....	98, 124–126, 135, 154–155, 167, 171, 180–181, 183–185, 209
Ratchet / ratcheting wrench.....	98, 124–126, 135, 154–155, 167, 171, 180–181, 183–184, 209
Ratchet box.....	122–124, 133, 144, 149, 167, 169–175, 209, 297–298
Ratcheting combination wrench.....	98, 111, 180–181, 183
Ratcheting combination wrench with hinge.....	98, 183
Refractometer.....	263
Release lever	218–220, 303
Reversible ratchet.....	124–126, 135, 154–155, 167, 209
Ribe CV tool.....	104, 147–148, 161
Rotary handle ratchet.....	125–126, 135, 155
Rotation angle tester	229
Round file	224
Round-nose pliers.....	212
Rubber hammer.....	304

S	
Sabre saw.....	221–222
Safety platform.....	249
Scraper.....	100–101, 215, 217
Screw extractor	150, 165
Screwdriver socket.....	96–97, 107–108, 111, 128–129, 134, 137–141, 145–148, 152–153, 158–163, 210
Screwdrivers and bits	96–97, 99, 101, 104, 107–109, 112, 117, 125, 128–129, 131, 137–141, 143, 145–148, 158–164, 186–193, 196–198, 210–211
Seeger ring pliers.....	102, 200–202, 204, 262
Serration tool.....	97, 104, 146, 158–159
Service jacks and jack stands.....	299–302
Service trolley.....	57
Set / assortment.....	95–109, 116–119, 122–124, 133, 144–147, 149, 167–170, 172–175, 183, 187–189, 191–193, 201, 203, 209, 211, 215, 217–220, 225, 240–242, 247, 256, 259, 261–262, 264, 266–267, 269–270, 272, 276, 278, 280, 288–289, 294, 297–298, 301–303, 308–309, 315
Shears / knife	221–223, 225
Shock absorber tool.....	315–316
Sliding head.....	143
Sliding T-handle / sliding piece.....	126, 155, 167
Slot profile tool.....	129, 137, 186, 210–211
Snap ring pliers	102, 200–202, 204, 262
Snipe nose pliers.....	199, 207, 212
Socket.....	95–96, 101–103, 105–107, 116, 118, 122–131, 133–151, 154–175, 192, 209–210, 260, 285, 296–297
Socket combinations.....	110, 122, 170–175
Socket wrench set.....	122–124, 133, 144, 149, 167, 169–175, 209, 297–298
Soft face hammer.....	213, 304
Soft foam insert.....	95–109, 113–119

Alphabetical index of key words



S

Soldering iron.....	242
Solid steel ratchet.....	124–125, 135, 154
Spanner socket set.....	122–124, 133, 144, 149, 167, 169–170, 172–175
Spark plug tools.....	137, 157, 199–200, 260
Spatula.....	240
Specialty tool for	
brakes.....	278–282, 284–294
axles.....	317
electricians.....	101, 104, 209–212
wheels / tyres.....	296–297, 303–306
Spin type speeder.....	126
Square drive	
6.3 mm (1/4 inch).....	95, 105–106, 116, 122–131, 143, 173–175
10 mm (3/8 inch).....	128, 131, 133–143, 157, 164, 176–177, 260
12.5 mm (1/2 inch).....	95, 105–106, 116, 130, 143–151, 154–168, 173–175, 209–210, 233, 296–298
20 mm (3/4 inch).....	167–169
Steering wheel level.....	304
Storage shelf.....	64, 84
Supporting joint tool.....	315
Swivel castor.....	62
Synthetic repair tool.....	309

T

T-handle screwdriver.....	109, 193
Tamper-resistant hexalobular tool.....	138–139
Tape measure.....	220
Telescopic inspection mirror.....	240
Testing / measuring.....	229, 254, 268–269, 290, 293
Tool case / box.....	92–93, 171, 176–177
Tool chest.....	49
Tool hook.....	65
Tool organisation.....	29–31, 33–40, 42–44, 46–60, 62–65, 67–69, 72, 75, 77–80, 82–89, 95–109, 116–119
Tool trolley and accessories.....	29–31, 33–40, 42–44, 48–53, 55–60, 62–65
Tools for engines.....	259, 261–263, 266–268, 270
Tools for motor vehicles.....	254–256, 315, 318–319
Torque tool.....	229
TORX® Tool.....	96, 99, 104, 127–128, 134, 137–139, 146, 153, 157, 159–162, 171, 189, 191, 193
Tray.....	242
Tube cutter.....	225
Tube flaring tool.....	287–290, 292
Turbo system diagnostics.....	261, 266–267
Twist drill bits.....	225
Tyre iron pry bar.....	303
Tyre lever.....	303

U

Under-bench drawer cabinet.....	70–74
Universal joint.....	131, 142, 163, 169
Universal pliers.....	208

V

V-ribbed belt tool.....	262
Vacuum and pressure pump.....	269, 275
VDE tools.....	101–102, 104, 209–212
Vernier calliper.....	221

V

Vice.....	65
VIGOR 1000.....	33–35, 46–47, 54
VIGOR 1000 XD.....	42–43, 53
VIGOR 1000 XL.....	38–40, 44, 51–52, 55–56
VSS – VIGOR Storage System.....	65, 67–80, 82–89

W

Wall cabinet.....	78
Wall unit.....	65, 67–80, 82–89
Window pane holder.....	250
Wiper arm puller.....	308
Wire brush.....	225
Wire stripper.....	212
Wobble / flexible extension.....	130, 142, 164
Wooden worktop.....	63
Work bench and accessories.....	46–47, 54–55
Work platform / ladder.....	249
Workshop equipment.....	65, 67–69, 72, 75, 77–80, 8 2–89, 242–246, 250, 252, 318
Worktop.....	63, 82–83
Wrench.....	97–98, 108–109, 180–184
Wrenching bar.....	218–220, 303

X

XZN tools.....	97, 104, 134, 146, 152, 158–159
----------------	---------------------------------



Numerical Index

VIGOR No.	Page	VIGOR No.	Page	VIGOR No.	Page	VIGOR No.	Page	VIGOR No.	Page
V1008	181	V1461N-10X11	178	V1789	224	V1982	128	V2074	158
V1009	181	V1461N-12X13	178	V1790	224	V1983	128	V2075	158
V1010	181	V1461N-14X15	178	V1801	224	V1984	128	V2076	158
V1021	181	V1461N-16X17	178	V1802	203	V1985	128	V2077	158
V1022	181	V1461N-18X19	178	V1803	203	V1986	128	V2078	158
V1023	181	V1461N-20X22	178	V1804	203	V1987	128	V2079	158
V1025	181	V1461N-21X23	178	V1808	203	V1988	157	V2080	158
V1026	181	V1461N-24X27	178	V1897	124	V1989	157	V2081	158
V1027	181	V1461N-25X28	178	V1898	149	V1990	157	V2082	158
V1028	181	V1461N-30X32	178	V1901	49	V1991	157	V2083	158
V1029	181	V1524N	180	V1901/376	32	V1992	157	V2084	158
V1030	181	V1524N-6X7	180	V1902	49	V1993	157	V2085	158
V1031	181	V1524N-8X9	180	V1903	63	V1994	157	V2086	158
V1135	213	V1524N-10X11	180	V1904	63	V1995	157	V2087	158
V1138	211	V1524N-12X13	180	V1905	62	V1996	157	V2088	158
V1208	186	V1524N-14X15	180	V1906	62	V1997	157	V2089	158
V1209	186	V1524N-16X17	180	V1907	62	V1998	157	V2090	158
V1212	213	V1524N-18X19	180	V1908	62	V1999	157	V2091	158
V1213	215	V1524N-20X22	180	V1909	63	V2000	157	V2092	158
V1214	214	V1524N-21X23	180	V1917	146	V2001	157	V2094	158
V1215	214	V1524N-24X27	180	V1918	146	V2002	157	V2095	158
V1216	214	V1524N-25X28	180	V1919	147	V2003	157	V2096	158
V1217	214	V1524N-30X32	180	V1963-3	265	V2004	157	V2097	158
V1218	214	V1571	304	V1963-4	265	V2014	131	V2098	158
V1219	214	V1584	303	V1963-5	265	V2016N	136	V2099	158
V1220	214	V1637	187	V1963-6	265	V2017N	136	V2100	158
V1221	214	V1657	303	V1963-7	265	V2018N	136	V2101	158
V1222	214	V1698	186	V1963-22	265	V2019N	136	V2102	158
V1281	273	V1699	186	V1963-25	265	V2020N	136	V2103	158
V1283	215	V1700	186	V1963/28	264	V2027	211	V2104	158
V1293	170	V1701	186	V1963N-6	264	V2028	210	V2105	158
V1301	220	V1702	186	V1963N-8	264	V2029	210	V2106	158
V1304	221	V1703	186	V1963N-9	264	V2030	210	V2107	158
V1345	223	V1704	186	V1963N-A	264	V2031-T15	211	V2108	143
V1368N	215	V1706N	172	V1963N-B	264	V2031-T20	211	V2109	164
V1369	218	V1707	225	V1963N-C	264	V2031-T25	211	V2110	164
V1371	218	V1711-1	281	V1963N-E	264	V2031-T30	211	V2111	167
V1371-1	218	V1711N	281	V1963N-F	264	V2059	159	V2112	272
V1371-2	218	V1713	221	V1963N-G	264	V2060	159	V2113	159
V1371-3	218	V1714	220	V1963N-H	264	V2061	210	V2114N	143
V1371-4	218	V1715	221	V1963N-M	264	V2062	210	V2115N	142
V1371-5	218	V1722	254	V1963N-R	264	V2063	210	V2116N	143
V1371-6	218	V1728	288	V1963N-S	265	V2064	210	V2117N	142
V1372	215	V1740	241	V1963N-T	265	V2065	158	V2118N	142
V1409	193	V1741	241	V1963N-X	265	V2066	159	V2119N	137
V1410	193	V1764	241	V1970	50	V2067	159	V2120N	137
V1423	304	V1781	171	V1976	128	V2068	159	V2121	159
V1438	241	V1782	288-289, 292	V1977	128	V2069	158	V2122	159
V1446	223	V1783	214	V1978	128	V2070	158	V2123	159
V1461N	178	V1787	224	V1979	128	V2071	143	V2124	159
V1461N-6X7	178	V1788	224	V1980	128	V2072	158	V2126	159
V1461N-8X9	178			V1981	128	V2073	158	V2128	159

Numerical Index



VIGOR No.	Page	VIGOR No.	Page	VIGOR No.	Page	VIGOR No.	Page	VIGOR No.	Page
V2129	159	V2187	127	V2267N	136	V2326N	168	V2424N	127
V2130N	128	V2188	127	V2268N	136	V2327N	168	V2425N	127
V2132	159	V2189	127	V2269N	136	V2328N	168	V2426N	127
V2133	159	V2194	138	V2270N	136	V2329N	168	V2427N	129
V2134	159	V2195	138	V2271N	136	V2331N	168	V2428N	129
V2135	159	V2196	157	V2272N	136	V2332N	168	V2429N	129
V2136	128	V2197	157	V2273N	136	V2333N	168	V2430N	129
V2137	159	V2201	147	V2274N	136	V2334N	168	V2431N	129
V2138	128	V2202	161	V2275N	136	V2335N	168	V2432N	129
V2139	128	V2203	161	V2276N	136	V2336N	168	V2433N	129
V2140	128	V2204	161	V2277N	136	V2337N	168	V2434N	129
V2141	128	V2205	161	V2278N	136	V2338	246	V2435N	129
V2142	128	V2206	161	V2279N	141	V2379N	29	V2436N	129
V2143	137	V2207	161	V2280N	141	V2393	60	V2437N	129
V2144	137	V2208	161	V2281N	141	V2393-S	60	V2438N	129
V2145	137	V2209	161	V2282N	141	V2393-XD	60	V2439N	129
V2146	137	V2210	161	V2283N	141	V2394	225	V2440N	129
V2149	139	V2211	161	V2284N	141	V2395	225	V2441N	129
V2151	159	V2212	161	V2285N	141	V2396	225	V2442N	128
V2152	159	V2213	161	V2286N	137	V2397	59	V2443N	128
V2153	159	V2214	161	V2287N	137	V2400	177	V2444N	128
V2154	159	V2215	161	V2288N	137	V2404N	150	V2445N	128
V2155	159	V2216	161	V2289N	138	V2404N-6	165	V2446N	128
V2156	159	V2217	161	V2290N	138	V2404N-7	165	V2447N	128
V2157	159	V2218	161	V2291N	138	V2404N-8	165	V2452N	131
V2158	159	V2219	161	V2292N	138	V2404N-9	165	V2453N	126
V2159	159	V2220	161	V2293N	138	V2404N-10	165	V2454N	131
V2160	159	V2221	161	V2294N	138	V2404N-11	165	V2455N	130
V2161	159	V2222	161	V2295N	139	V2404N-12	165	V2456N	130
V2162	159	V2223	161	V2296N	139	V2404N-13	165	V2457N	130
V2163	159	V2224	161	V2297N	139	V2404N-14	165	V2458N	126
V2165	159	V2225	161	V2298N	139	V2404N-15	165	V2459N	263
V2167	159	V2226	161	V2299N	139	V2404N-16	165	V2460N	144
V2168	159	V2227	161	V2300N	139	V2404N-17	165	V2461N	173
V2169	159	V2228	161	V2301N	139	V2404N-19	165	V2462	63
V2170	159	V2229	161	V2302N	139	V2404N-21	165	V2464	177
V2171	159	V2230	161	V2303N	139	V2404N-22	165	V2465N	156
V2172	159	V2231	161	V2305N	133	V2404N-24	165	V2466	288
V2173	160	V2232	161	V2311N	136	V2404N-27	165	V2467	288
V2174	160	V2233	161	V2312N	136	V2404N-30	165	V2471	298
V2175	160	V2234	304	V2313N	136	V2404N-32	165	V2472	298
V2176	160	V2235	304	V2314N	136	V2413N	127	V2473	298
V2177	160	V2249	291	V2315N	136	V2414N	123	V2474	298
V2178	160	V2250	291	V2317N	168	V2415N	127	V2475	298
V2179	160	V2256N	168	V2318N	167	V2416N	127	V2477	301
V2180	160	V2257	298	V2319N	167	V2417N	127	V2478	301
V2181	160	V2261N	136	V2320N	168	V2418N	127	V2481	299
V2182	160	V2262N	136	V2321N	168	V2419N	127	V2482	193
V2183	160	V2263N	136	V2322N	167	V2420N	127	V2483	193
V2184	160	V2264N	136	V2323N	168	V2421N	127	V2484	193
V2185	127	V2265N	136	V2324N	168	V2422N	127	V2485	193
V2186	127	V2266N	136	V2325N	168	V2423N	127	V2486	193



Numerical Index

VIGOR No.	Page	VIGOR No.	Page	VIGOR No.	Page	VIGOR No.	Page	VIGOR No.	Page
V2487	215	V2554	288	V2629	212	V2808	183	V3393	189
V2488	215	V2555	288	V2630	212	V2809	183	V3427N	192
V2489	193	V2556	288	V2631	299	V2810	183	V3441	229
V2490	193	V2558	288	V2632	299	V2811	183	V3451	225
V2491	218	V2559	288	V2639	299	V2812	183	V3541	213
V2492	218	V2561N	156	V2640	299	V2813	183	V3551N	309
V2493	218	V2562N	156	V2641	212	V2814	183	V3551N-ABS	309
V2494	218	V2563N	156	V2643	212	V2817	183	V3551N-PE	309
V2495	218	V2564N	156	V2645	272	V2818	183	V3551N-PP	309
V2496	145	V2565N	156	V2647N	164	V2820	181	V3551N-PS	309
V2497	193	V2566N	156	V2648	302	V2821	180	V3551N-W	309
V2498	193	V2567N	156	V2662	213	V2822	180	V3562	187
V2499	256	V2568N	156	V2663	213	V2823	180	V3563	303
V2499-A	256	V2569N	156	V2664	213	V2824	180	V3571	262
V2499-B	256	V2570N	156	V2665	213	V2825	180	V3597	186
V2499-C	256	V2571N	156	V2667N	155	V2826	180	V3598	186
V2499-D	256	V2572N	156	V2687	170	V2827	180	V3599	186
V2499-F	256	V2573N	155	V2699N	127	V2828	180	V3600	186
V2501	193	V2574N	156	V2700N	127	V2829	180	V3601	186
V2502	193	V2575N	163	V2701N	127	V2830	180	V3602	186
V2503	193	V2576N	164	V2705	184	V2831	180	V3607	184
V2504	193	V2577N	164	V2712N	30	V2832	180	V3609	186
V2505	193	V2578N	157	V2722	127	V2833	180	V3610	186
V2506	193	V2579N	156	V2723	127	V2837	106	V3613	186
V2507	193	V2580N	156	V2724	137	V2838	106	V3615	303
V2508	215	V2581N	156	V2725	137	V2924N	168	V3635	181
V2509	215	V2582N	157	V2726	137	V2941	126	V3636	181
V2511N	273	V2584N	156	V2727	137	V3277N	174	V3651N	131
V2512	303	V2585N	156	V2728	137	V3309	225	V3652N	143
V2513	303	V2586N	156	V2729	137	V3330	210	V3653	232
V2514	303	V2587N	156	V2730	157	V3331	210	V3661	315
V2515	303	V2588N	156	V2731	157	V3332	210	V3670N	309
V2516	303	V2589N	156	V2732	157	V3333	210	V3671N	309
V2517	65	V2590N	156	V2733	157	V3334	210	V3672N	309
V2518	65	V2591N	156	V2734	157	V3335	210	V3673N	309
V2519	65	V2592N	157	V2735	157	V3336	210	V3676N	309
V2520	65	V2593N	129	V2762	301-302	V3337	210	V3677N	309
V2521	273	V2594N	129	V2781	199	V3338	210	V3681	276
V2522	298	V2595N	128	V2782	199	V3339	210	V3682	276
V2523	308	V2596N	128	V2783	199	V3340	210	V3683	276
V2533N	127	V2597N	129	V2788	206	V3341	210	V3684	276
V2534N	127	V2598N	156	V2788-4.0	206	V3342	209	V3685	276
V2535N	127	V2599N	156	V2788-3.2	206	V3343	209	V3686	276
V2536N	127	V2600N	156	V2788-6.4	206	V3344	210	V3687	276
V2537N	127	V2603N	156	V2788-4.8	206	V3366	189	V3688	276
V2538N	127	V2613N	137	V2789N	290	V3367	189	V3689	276
V2539N	127	V2614N	137	V2790N	222	V3368	189	V3690	276
V2540	288	V2615N	137	V2795	229	V3369	189	V3691	276
V2542	177	V2616N	142	V2804	183	V3370	189	V3729	265
V2551	288	V2626	225, 288	V2805	183	V3381	262	V3734N	122
V2552	288	V2627	222	V2806	183	V3391	189	V3735	206
V2553	288	V2628	212	V2807	183	V3392	189	V3735-M10	206

Numerical Index



VIGOR No.	Page	VIGOR No.	Page	VIGOR No.	Page	VIGOR No.	Page	VIGOR No.	Page
V3735-M5	206	V3760-11	282	V4278	240	V4433	188	V4473N-30	179
V3735-M6	206	V3760-12	282	V4279	240	V4434	188	V4473N-32	179
V3735-M8	206	V3760N	282	V4303	192	V4435	188	V4473N-36	179
V3735-4.0	206	V3863	315	V4304	267	V4436	188	V4477	166
V3735-3.2	206	V3898	229	V4305	267	V4437	188	V4478	166
V3735-6.4	206	V3899	229	V4306	267	V4438	188	V4481	51
V3735-4.8	206	V4111	62	V4308	222	V4451	255	V4481-X	52
V3738	202	V4112	62	V4309	296	V4451-1	255	V4481-X-4	60
V3738-S	202	V4113	276	V4310N	219	V4451-2	255	V4481-X-5	64
V3739	202	V4114	276	V4311	130	V4451-3	255	V4481-X/375	38
V3741	150	V4115	276	V4312	130	V4451-4	255	V4481-X/466	39
V3760-0	283	V4122	63	V4313	130	V4451-5	255	V4481-X/499	40
V3760-0-DISC	283	V4126N	315	V4314	142	V4451-6	255	V4481-XD	53
V3760-A	282	V4130	105	V4315	142	V4451-7	255	V4481-XD-1	63
V3760-A1	283	V4153	308	V4316	142	V4451-8	255	V4481-XD-2	62
V3760-B	282	V4154	308	V4317	164	V4451-9	255	V4481-XD-3	62
V3760-B1	283	V4155	308	V4318	164	V4451-10	255	V4481-XD-4	60
V3760-C	282	V4156	308	V4319	164	V4451-11	255	V4481-XD-5	64
V3760-D	282	V4157	308	V4322	237	V4451-12	255	V4481-XD/469	42
V3760-E	282	V4158	308	V4324	254	V4451-13	255	V4481-XD/775	43
V3760-F	282	V4159	308	V4324-1	254	V4451-14	255	V4481-XXL	56
V3760-F1	283	V4160	308	V4324-2	254	V4451-15	255	V4481-XXL/929	44
V3760-G	282	V4161	308	V4325	269	V4451-16	255	V4521	116
V3760-G1	283	V4163	308	V4326N	257	V4451-17	255	V4542	36
V3760-H6	283	V4164	308	V4369	275	V4451-18	255	V4560	34
V3760-H7	283	V4165	308	V4381	279	V4451-19	255	V4561	35
V3760-IV	283	V4188	105	V4381-1	279	V4451-20	255	V4586	116
V3760-J	282	V4192	266	V4381-2	279	V4451-21	255	V4631	119
V3760-K	283	V4196	205	V4381-3	279	V4451-22	255	V4632	119
V3760-K1	283	V4199	192	V4381-4	279	V4451-23	255	V4633	119
V3760-K2	283	V4200	192	V4383	276	V4461	268	V4636N	319
V3760-M	283	V4201	275	V4384	276	V4472N	179	V4637N	204
V3760-N	283	V4201-1	275	V4385N	276	V4473N	179	V4638	249
V3760-P	283	V4202	265	V4398N	164	V4473N-6	179	V4640	203
V3760-P1	283	V4219	31	V4399	286	V4473N-7	179	V4641	204
V3760-Q	283	V4221	192	V4411	278	V4473N-8	179	V4642	317
V3760-R	283	V4222	192	V4413	274	V4473N-9	179	V4646	247
V3760-S	283	V4223	192	V4414	274	V4473N-10	179	V4646M-8	247
V3760-T	283	V4224	192	V4415	274	V4473N-11	179	V4646M-9	247
V3760-V	283	V4225	192	V4416	287	V4473N-12	179	V4646M-10	247
V3760-VW	283	V4227	239	V4416-1	287, 289	V4473N-13	179	V4646M-11	247
V3760-X	283	V4228	239	V4416-2	287, 289	V4473N-14	179	V4646M-12	247
V3760-Z	283	V4230	109	V4416-3	287, 289	V4473N-15	179	V4646M-13	247
V3760-1	282	V4231	109	V4416-4	287, 289	V4473N-16	179	V4646M-14	247
V3760-2	282	V4233	266	V4416-5	287	V4473N-17	179	V4646M-15	247
V3760-3	282	V4235	213	V4418	189	V4473N-18	179	V4646M-16	247
V3760-4	282	V4241	239	V4419	189	V4473N-19	179	V4646M-17	247
V3760-5	282	V4248	315	V4420	189	V4473N-20	179	V4646M-18	247
V3760-6	282	V4249	315	V4421	189	V4473N-21	179	V4646M-19	247
V3760-7	282	V4250	315	V4422	189	V4473N-22	179	V4646N-8	247
V3760-8	283	V4274	222	V4425N	176	V4473N-24	179	V4646N-9	247
V3760-9	283	V4275	222	V4432/6	188	V4473N-27	179	V4646N-10	247



Numerical Index

VIGOR No.	Page	VIGOR No.	Page	VIGOR No.	Page	VIGOR No.	Page	VIGOR No.	Page
V4646N-11	247	V4813	54	V4941N-2	270	V5017-L	101	V5182	168
V4646N-12	247	V4813-1	63	V4941N-3	270	V5018	119	V5183	168
V4646N-13	247	V4813-2	64	V4941N-4	270	V5019	196	V5191	57, 62
V4646N-14	247	V4814	55	V4941N-5	270	V5020	197	V5202	122
V4646N-15	247	V4814-1	62	V4941N-10	270	V5024	168	V5434	37
V4646N-16	247	V4814-2	62	V4941N-11	270	V5025	168	V5436	125
V4646N-17	247	V4814-3	62	V4941N-19T	270	V5026	168	V5437	155
V4646N-18	247	V4814-4	63	V4941N-20	270	V5042	186	V5461	175
V4646N-19	247	V4884	154	V4941N-22	270	V5043	186	V5480	240
V4646S-8	247	V4884-01	154	V4941N-245	270	V5044	186	V5485N	190
V4646S-9	247	V4885	219	V4942	191	V5045	215	V5488	242
V4646S-10	247	V4891	311	V4944-REP	124	V5048	272	V5489	48
V4646S-11	247	V4891-1	311	V4944-S	124	V5055	33	V5489-1	63
V4646S-12	247	V4891-1.0	310	V4944-XS	125	V5068	99	V5489-2	64
V4646S-13	247	V4891-2	311	V4945-REP	135	V5068-L	99	V5489-3	62
V4646S-14	247	V4891-3	311	V4945-S	135	V5070	100	V5489-4	62
V4646S-15	247	V4891-3.5	313	V4946-REP	154	V5070-L	100	V5489-5	64
V4646S-16	247	V4891-3.5-1	313	V4946-S	154	V5072	101	V5493	199
V4646S-17	247	V4891-3.5-2	313	V4961	181	V5072-L	101	V5494	200
V4646S-18	247	V4891-3.5-3	313	V4962	181	V5075	98	V5496	200
V4646S-19	247	V4891-3.5-4	313	V4963	181	V5075-L	98	V5496-1	200
V4651	222	V4891-3.5-5	313	V4964	181	V5077	98	V5497	200
V4655	187	V4891-3.5-6	313	V4965	181	V5077-L	98	V5502	196
V4661	213	V4891-4	311	V4966	181	V5081	104	V5505	169
V4661-1	213	V4891-5	312	V4971	95	V5081-L	104	V5505-1/2	169
V4663	215	V4891-6	312	V4971-L	95	V5085	104	V5505-1/4	169
V4664	190	V4891-7	312	V4973	95	V5085-L	104	V5505-3/8	169
V4665	190	V4891-8	312	V4973-L	95	V5087	104	V5512	242
V4666	190	V4891-9	312	V4975	95	V5087-L	104	V5513	289
V4667	186	V4891-10	312	V4975-L	95	V5091	97	V5513-1	289
V4668	278	V4891-10.0	314	V4987	98	V5091-L	97	V5513-2	289
V4690	221	V4891/6	312	V4987-L	98	V5095	96	V5513-3	289
V4697	287	V4893	64	V4989	99	V5095-L	96	V5531	250
V4697-1	287	V4930	286	V4989-L	99	V5097	97	V5550L	151
V4697-2	287, 289	V4941N	270	V4991	99	V5097-L	97	V5550L-10	165
V4700-A	93	V4941N-BK	270	V4991-L	99	V5099	96	V5550L-11	165
V4700-L	92	V4941N-BL	270	V4995	99	V5099-L	96	V5550L-12	165
V4700-R	93	V4941N-M5	270	V4995-L	99	V5103	103	V5550L-13	165
V4700-XL	92	V4941N-R1	270	V4999N	102	V5103-L	103	V5550L-14	165
V4700-XXL	93	V4941N-R10	270	V4999N-L	102	V5109	107	V5550L-15	165
V4701	275	V4941N-R11	270	V5004	100	V5109-L	107	V5550L-16	165
V4708	191	V4941N-R12	270	V5004-L	100	V5111N	114	V5550L-17	165
V4709N	156	V4941N-R13	270	V5006	100	V5111N-L	114	V5550L-18	165
V4726	107	V4941N-R2	270	V5006-L	100	V5115	106	V5550L-19	165
V4727	107	V4941N-R3	270	V5009	119	V5115-L	106	V5550L-21	165
V4728	108	V4941N-R4	270	V5011	101	V5156	46	V5550L-22	165
V4729	108	V4941N-R5	270	V5011-L	101	V5158	47	V5550L-24	165
V4737	204	V4941N-R6	270	V5013	101	V5170	117	V5550S	151
V4752	107	V4941N-R7	270	V5013-L	101	V5170-L	117	V5550S-10	165
V4753	107	V4941N-R8	270	V5015	102	V5175	109	V5550S-11	165
V4758	57	V4941N-R9	270	V5015-L	102	V5175-L	109	V5550S-12	165
V4800N	231	V4941N-1	270	V5017	101	V5180	57, 62	V5550S-13	165

Numerical Index



VIGOR No.	Page	VIGOR No.	Page	VIGOR No.	Page	VIGOR No.	Page	VIGOR No.	Page
V5550S-14	165	V6000-01	72	V6000-042	79	V6012	154	V6103	139
V5550S-15	165	V6000-01XD	72	V6000-042XL	79	V6012-REP	154	V6104	139
V5550S-16	165	V6000-01XL	72	V6000-043	85	V6014	124	V6105	139
V5550S-17	165	V6000-02	75	V6000-044	80	V6014-REP	124	V6106	140
V5550S-18	165	V6000-02XD	76	V6000-044XL	80	V6015	118	V6107	140
V5550S-19	165	V6000-02XL	76	V6000-046	78	V6015-L	118	V6108	140
V5550S-21	165	V6000-3	69	V6000-046XL	78	V6017	134	V6109	140
V5550S-22	165	V6000-03	77	V6000-047LR	88	V6018	134	V6110	140
V5550S-24	165	V6000-3-X	69	V6000-047M	88	V6019	134	V6111	140
V5591	220	V6000-03XL	77	V6000-048	84	V6028	299	V6112	140
V5601	191	V6000-3P1XL	67	V6000-050	86	V6028-1	299	V6113	140
V5602	96	V6000-3P1XL-X	67	V6000-051	86	V6028-2	299	V6114	140
V5602-L	96	V6000-3P2XL	68	V6000-052	87	V6028-3	299	V6115	140
V5603	102	V6000-3P2XL-X	68	V6000-053	87	V6028-4	299	V6116	140
V5603-L	102	V6000-04	78	V6000-054	87	V6029	300	V6117	140
V5631	211	V6000-04XL	78	V6000-055	88	V6029-1	300	V6118	140
V5632	209	V6000-05	84	V6000-055XL	88	V6029-2	300	V6119	140
V5633N	102	V6000-05S	84	V6000-0676	82	V6029-3	300	V6120	140
V5633N-L	102	V6000-05SP	84	V6000-0676-D	83	V6030	217	V6121	140
V5634N	114	V6000-05SXL	84	V6000-0676-X	82	V6030-12	217	V6122	140
V5634N-L	114	V6000-09	85	V6000-0676-XD	83	V6030-16	217	V6123	140
V5636N	115	V6000-010	85	V6000-0860	82	V6030-20	217	V6124	140
V5636N-L	115	V6000-011	76	V6000-0860-X	82	V6031	300	V6125	140
V5637N	115	V6000-015	84	V6000-0861	82	V6031-1	300	V6126	140
V5637N-L	115	V6000-015S	84	V6000-0861-D	83	V6031-2	300	V6127	140
V5638N	117	V6000-015SP	84	V6000-0861-X	82	V6031-3	300	V6128	140
V5638N-L	117	V6000-015SXL	84	V6000-0861-XD	83	V6038	135	V6129	140
V5639	208	V6000-017	84	V6000-01083-D	83	V6038-REP	135	V6130	140
V5639-24	208	V6000-017XL	84	V6000-01083-XD	83	V6048	185	V6131	140
V5649	290	V6000-018	84	V6000-01357	82	V6049	185	V6137	141
V5650	199	V6000-018XL	84	V6000-01357-D	83	V6068	197	V6138	141
V5660	263	V6000-019	73	V6000-01357-X	82	V6082	138	V6139	141
V5661	190	V6000-019XL	73	V6000-01357-XD	83	V6083	138	V6140	141
V5671N	231	V6000-020	86	V6000-01541	82	V6084	139	V6141	141
V5672	234	V6000-029	70	V6000-01541-X	82	V6085	139	V6142	141
V5673	234	V6000-029XL	70	V6000-01725	82	V6086	139	V6143	141
V5674	233	V6000-030	70	V6000-01725-D	83	V6087	139	V6144	141
V5675	233	V6000-030XL	70	V6000-01725-X	82	V6088	139	V6145	141
V5676	259	V6000-031	71	V6000-01725-XD	83	V6089	139	V6146	141
V5677	242	V6000-031XD	71	V6000-02036	82	V6090	139	V6147	141
V5678	243	V6000-031XL	71	V6000-02036-D	83	V6091	139	V6148	141
V5679M	250	V6000-032	73	V6000-02036-X	82	V6092	139	V6149	141
V5680	250	V6000-032XL	74	V6000-02036-XD	83	V6093	139	V6150	65
V5681	208	V6000-033	74	V6000-02215	82	V6094	139	V6151	141
V5691	290	V6000-033XL	74	V6000-02215-X	82	V6095	139	V6152	141
V5885	219	V6000-035	75	V6000-02404	82	V6096	139	V6153	141
V5909	291	V6000-035XL	75	V6000-02404-X	82	V6097	139	V6154	141
V5922	263	V6000-036	80	V6000-02588	82	V6098	139	V6155	141
V5930	296, 298	V6000-036XL	80	V6000-02588-D	83	V6099	139	V6156	141
V5931	297-298	V6000-037	77	V6000-02588-X	82	V6100	139	V6157	141
V5932	297-298	V6000-040/4	85	V6000-02588-XD	83	V6101	139	V6158	141
V5933/3	298	V6000-041/4	86	V6008	135	V6102	139	V6159	141



Numerical Index

VIGOR No.	Page	VIGOR No.	Page	VIGOR No.	Page	VIGOR No.	Page	VIGOR No.	Page
V6160	141	V6452-21	316	V6686/5	61	V6809	111	V7015N	118
V6161	141	V6452-22	316	V6687/5	61	V6809-L	111	V7015N-L	118
V6194	141	V6452-24	316	V6687H/5	61	V6809-4	225	V7017	153
V6200	217	V6452-250	316	V6688	61	V6810	111	V7017-T30	165
V6200-2	217	V6468	243	V6688-XD	61	V6810-L	111	V7017-T40	165
V6200-3	217	V6500-140	207	V6688-XL	61	V6810-115K40	248	V7017-T45	165
V6200-4	217	V6500-160	207	V6688H	61	V6810-115K60	248	V7017-T50	165
V6200-5	217	V6501-180	207	V6688H-XD	61	V6810-115K80	248	V7017-T55	165
V6200-6	217	V6502-200	207	V6688H-XL	61	V6810-125K60	248	V7017-T60	165
V6200-7	217	V6503-200	207	V6689	59	V6811	113	V7017-T70	165
V6200-8	217	V6504-250	208	V6721	97	V6811-L	113	V7017-T80	165
V6202	132	V6510-10/4	201	V6721-L	97	V6811-115	248	V7018	152
V6210-4	216	V6510-19/4	201	V6722	98	V6812	114	V7018-M10	166
V6210-10	216	V6510A-10	19, 201	V6722-L	98	V6812-L	114	V7018-M12	166
V6220-10	217	V6510A-19	19, 201	V6723	97	V6813	112	V7018-M14	166
V6220-16	217	V6510A-40	201	V6723-L	97	V6813-L	112	V7018-M16	166
V6220-20	217	V6510B-10	19, 201	V6724	109	V6814	112	V7018-M18	166
V6220-29	217	V6510B-19	19, 201	V6724-L	109	V6814-L	112	V7018-M5	166
V6220/4	217	V6510B-40	201	V6726	108	V6815N	115	V7018-M6	166
V6221	58	V6510C-12	19, 202	V6726-L	108	V6815N-L	115	V7018-M8	166
V6222	100	V6510C-19	19, 202	V6740	261	V6816N	118	V7019	152
V6222-L	100	V6510C-40	202	V6741	261	V6816N-L	118	V7019-H10	166
V6230-5	216	V6510D-12	19, 202	V6742	244	V6817	113	V7019-H12	166
V6230-7	216	V6510D-19	19, 202	V6752-8	182	V6817-L	113	V7019-H14	166
V6309	296	V6510D-40	202	V6752-9	182	V6818	113	V7019-H17	166
V6311	296	V6554	233	V6752-10	182	V6818-L	113	V7019-H19	166
V6312/10	297	V6605	244	V6752-11	182	V6821	110	V7019-H5	166
V6393	60	V6606	244	V6752-12	182	V6821-L	110	V7019-H6	166
V6393-S	60	V6611/4	185	V6752-13	182	V6822	110	V7019-H8	166
V6394	59	V6612N	155	V6752-14	182	V6822-L	110	V7037-IP10	128
V6395	58	V6612N-REP	155	V6752-15	182	V6831	116	V7037-IP15	128
V6396	58	V6614N	125	V6752-16	182	V6831-L	116	V7037-IP20	128
V6397	59	V6614N-REP	125	V6752-17	182	V6899N	232	V7037-IP25	128
V6398	57	V6632	283, 285	V6752-18	182	V6905	235	V7037-IP27	128
V6412/4	149	V6633	283, 285	V6752-19	182	V6906	234	V7037-IP30	128
V6435	245	V6634	283, 285	V6752/5	182	V6906-10	234	V7037-IP8	128
V6435-XL	245	V6635	283, 285	V6752/12	182	V6907	237	V7037-IPR10	129
V6436-L	245	V6636	285	V6799	205	V6907-1	237	V7037-IPR15	129
V6436-M	245	V6638N	135	V6800-50	226	V6917	292	V7037-IPR20	129
V6436-XL	245	V6638N-REP	135	V6800-75	226	V6917-REP	292	V7037-IPR25	129
V6436-XXL	245	V6643	108	V6801-65	227	V6952	220	V7037-IPR27	129
V6452	316	V6643-L	108	V6802	226	V6956	317	V7037-IPR30	129
V6452-H6	316	V6650	117	V6803-75	226	V6973	246	V7037-IPR8	129
V6452-H7	316	V6650-L	117	V6803-100	226	V6973-1	246	V7037-T8H	128
V6452-H8	316	V6685-1/20	61	V6804	227	V7001	306	V7055-H10	162
V6452-1	316	V6685-2/20	61	V6805	227	V7001/4	306	V7055-H12	162
V6452-5	316	V6685-3/10	61	V6806	227	V7002-14	260	V7055-H14	162
V6452-6	316	V6685-4/10	61	V6807	111	V7002-16	260	V7055-H5	162
V6452-16	316	V6685H/5	61	V6807-L	111	V7002-18	260	V7055-H6	162
V6452-17	316	V6685H-2/20	61	V6807-4	225	V7002-20.8	260	V7055-H7	162
V6452-18	316	V6685H-3/10	61	V6808	112	V7002/4	260	V7055-H8	162
V6452-19	316	V6685H-4/10	61	V6808-L	112	V7010-125K80	248	V7055-IP40	160

Numerical Index



VIGOR No.	Page	VIGOR No.	Page	VIGOR No.	Page	VIGOR No.	Page	VIGOR No.	Page
V7055-IP45	160	V7124-PZ2	188	V7212-H17	169	V7512-17	156	V7525	318
V7055-IP50	160	V7124-T20	188	V7212-H19	169	V7512-18	156	V7538-9	136
V7055-IP55	160	V7124-T25	188	V7212-H21	169	V7512-19	156	V7538-10	136
V7055-IP60	160	V7124-T30	188	V7212-M14	169	V7512-20	156	V7538-11	136
V7055-IPR40	160	V7132N	284	V7212-M16	169	V7512-21	156	V7538-12	136
V7055-IPR45	160	V7135	235	V7212-M18	169	V7512-22	156	V7538-13	136
V7055-IPR50	160	V7135-150	235	V7221	243	V7512-23	156	V7538-14	136
V7055-IPR55	160	V7140-H10	163	V7244	293	V7512-24	156	V7538-15	136
V7055-IPR60	160	V7140-H12	163	V7259	293	V7512-27	156	V7538-16	136
V7055-T20	161	V7140-H14	163	V7283	89	V7512-30	156	V7538-17	136
V7055-T25	161	V7140-H5	163	V7283/2	89	V7512-32	156	V7538-18	136
V7055-T27	161	V7140-H6	163	V7285	276	V7512-36	156	V7538-19	136
V7055-T30	161	V7140-H7	163	V7286	276	V7512/17	145	V7538/10	134
V7055-T40	161	V7140-H8	163	V7287	276	V7512L-10	156	V7538L-9	136
V7055-T40H	160	V7140-T40	162	V7288	276	V7512L-11	156	V7538L-10	136
V7055-T45	161	V7140-T45	162	V7323	96	V7512L-12	156	V7538L-11	136
V7055-T45H	160	V7140-T50	162	V7323-L	96	V7512L-13	156	V7538L-12	136
V7055-T50	161	V7140-T55	162	V7324	103	V7512L-14	156	V7538L-13	136
V7055-T50H	160	V7140-T60	162	V7324-L	103	V7512L-15	156	V7538L-14	136
V7055-T55	161	V7140-T70	162	V7385	274	V7512L-16	156	V7538L-15	136
V7055-T55H	160	V7143-10	236	V7401	286	V7512L-17	156	V7538L-16	136
V7055-T60H	160	V7158	285	V7402	249	V7512L-18	156	V7538L-17	136
V7075-H17	163	V7158-1	285	V7403	249	V7512L-19	156	V7538L-18	136
V7075-H19	163	V7158-2	285	V7471	280	V7512L-22	156	V7538L-19	136
V7075-T60	162	V7158-3	285	V7471-A	280	V7514-4	127	V7548	256
V7075-T70	162	V7158-4	285	V7471-T	280	V7514-5	127	V7548-1	256
V7099	223	V7158-5	285	V7471-TL	280	V7514-6	127	V7600	195
V7099/2	223	V7158-6	285	V7471-TS	280	V7514-7	127	V7601-150	194
V7100-H10	163	V7158-7	285	V7471-W	280	V7514-8	127	V7601-250	194
V7100-H11	163	V7158-8	285	V7471/17	280	V7514-9	127	V7603/3	195
V7100-H12	163	V7181	305	V7471L-7	280	V7514-10	127	V7614	195
V7100-H13	163	V7181-1	305	V7471L-8	280	V7514-11	127	V7638	195
V7100-H5	163	V7181-2	305	V7471L-9	280	V7514-12	127	V7784	198
V7100-H6	163	V7181-3	305	V7471L-10	280	V7514-13	127	V7917	148
V7100-H7	163	V7181-4	305	V7471L-11	280	V7514-14	127	V7919	148
V7100-H8	163	V7181-5	305	V7471L-12	280	V7514-4.5	127	V7920-EP10	137
V7100-T20	162	V7181-6	305	V7471S-7	280	V7514-5.5	127	V7920-EP12	137
V7100-T25	162	V7200-H10	163	V7471S-8	280	V7514/13	123	V7920-EP14	137
V7100-T27	162	V7200-H12	163	V7471S-9	280	V7514L-4	127	V7920-EP16	137
V7100-T30	162	V7200-H5	163	V7471S-10	280	V7514L-5	127	V7920-EP18	157
V7100-T40	162	V7200-H6	163	V7471S-11	280	V7514L-6	127	V7920-EP20	157
V7100-T45	162	V7200-H7	163	V7471S-12	280	V7514L-7	127	V7920-EP22	157
V7100-T50	162	V7200-H8	163	V7501/2	252	V7514L-8	127	V7920-EP24	157
V7100-T55	162	V7200-T40	162	V7512-8	156	V7514L-9	127	V7920-EP4	128
V7100-T60	162	V7200-T45	162	V7512-9	156	V7514L-10	127	V7920-EP5	128
V7100-T70	162	V7200-T50	162	V7512-10	156	V7514L-11	127	V7920-EP6	128
V7120	294	V7200-T55	162	V7512-11	156	V7514L-12	127	V7920-EP7	128
V7124	188	V7200-T60	162	V7512-12	156	V7514L-13	127	V7920-EP8	128
V7124-PH1	188	V7200-T70	162	V7512-13	156	V7514L-5.5	127		
V7124-PH2	188	V7202	144	V7512-14	156	V7520	103		
V7124-PH3	188	V7212	169	V7512-15	156	V7520-L	103		
V7124-PZ1	188	V7212-H14	169	V7512-16	156	V7524	253		

V1901/376, EAN 4047728080293

Tool trolley with assortment and plastic worktop



32

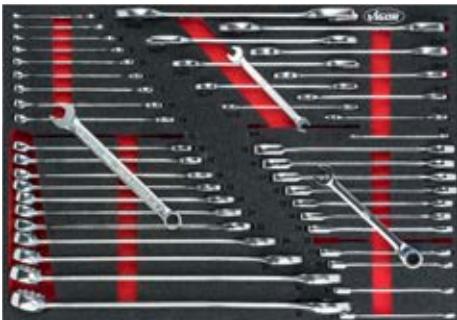
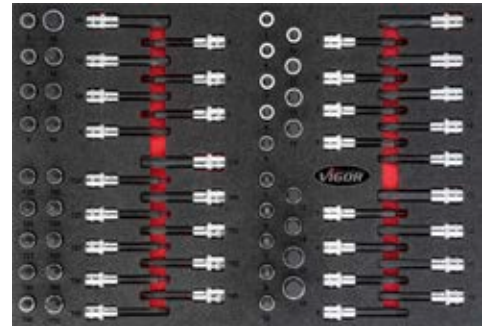

Overview of new products



V4481-XXL/929, EAN 4047728**082303**

Extra-deep, extra-wide tool trolley with assortment
and stainless steel worktop



44

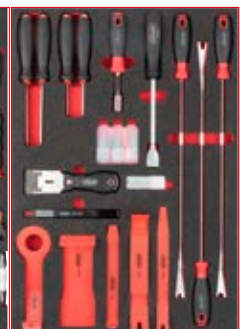
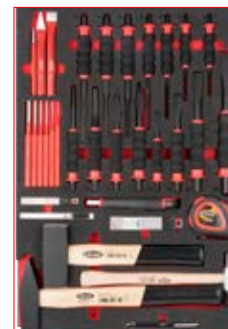
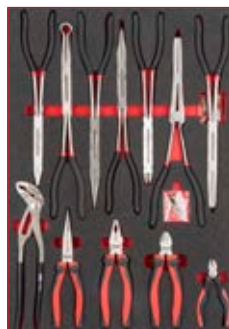
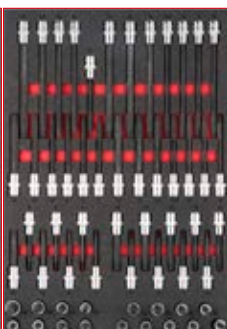
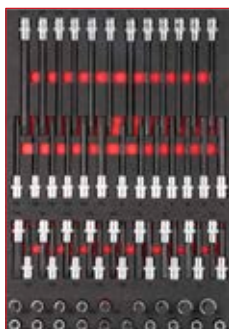
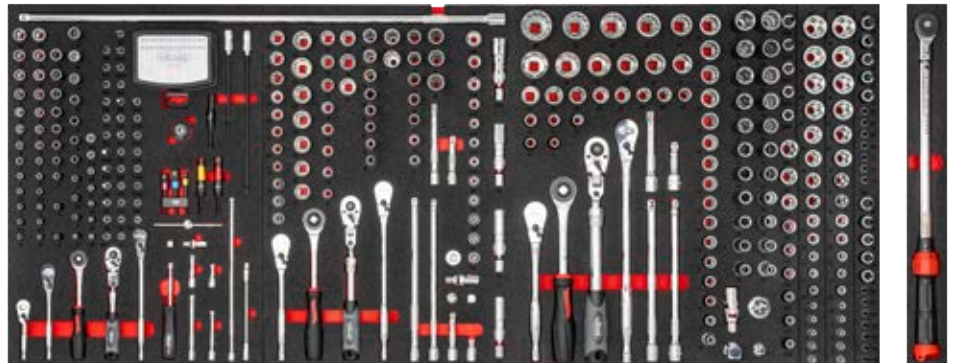

V6688H / V6688H-XL / V6688H-XD
Separation sheet set

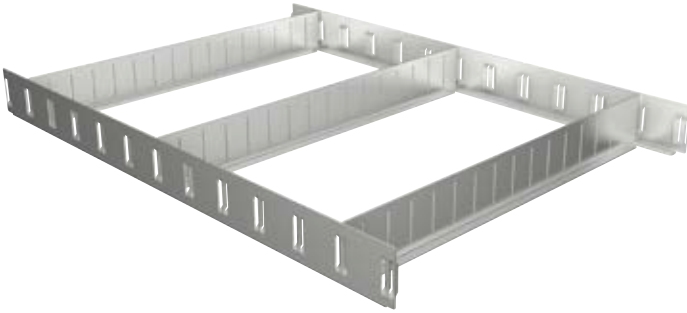

61

V6685H / V6685H-3/10 / V6685H-4/10
Separation sheet set



61

V6685H/5 / V6687H/5
Cross member set



61

V6000-031XD, EAN 4047728081184
Drawer lower cabinet · extra deep · 5 drawers



71

V6000-01XD, EAN 4047728081016
Drawer lower cabinet · extra deep · 7 drawers



72

V6000-02XD, EAN 4047728081191
Double hinged-doors lower cabinet · extra deep



76

Overview of new products



V7324, EAN 4047728080262
Impact socket set



103

V6612N / V6614N / V6638N
Telescopic reversible ratchet with hinge joint



125

135

155

V6412/4, EAN 4047728079518
Stud extractor set



149

V2404N, EAN 4047728080507
Extractor socket set with spiral profile



150

V5461, EAN 4047728080323
Socket set



175

V7601-150 / V7601-250
Bit holder with magnetic ring · long



194

V7600, EAN 4047728**079440**
Bit holder with articulated joint



195

V7603/3, EAN 4047728**079471**
Socket adapter set



195

V7614, EAN 4047728**079457**
Socket adapter · with hinge



195

V7638, EAN 4047728**079464**
Socket adapter · with hinge



195

V4640, EAN 4047728**081726**
Hose clamp pliers



203

V5639 / V5639-24
Pipe wrench



208

Overview of new products



V5632, EAN 4047728080279
VDE tool set



209

V5679M, EAN 4047728080637
Magnetic button set



250

V5680, EAN 4047728081436
Magnetic holder



250



V7501/2, EAN 4047728080255

Video borescope



252



Overview of new products



V7524, EAN 4047728081320
Flue gas leakage tester



253

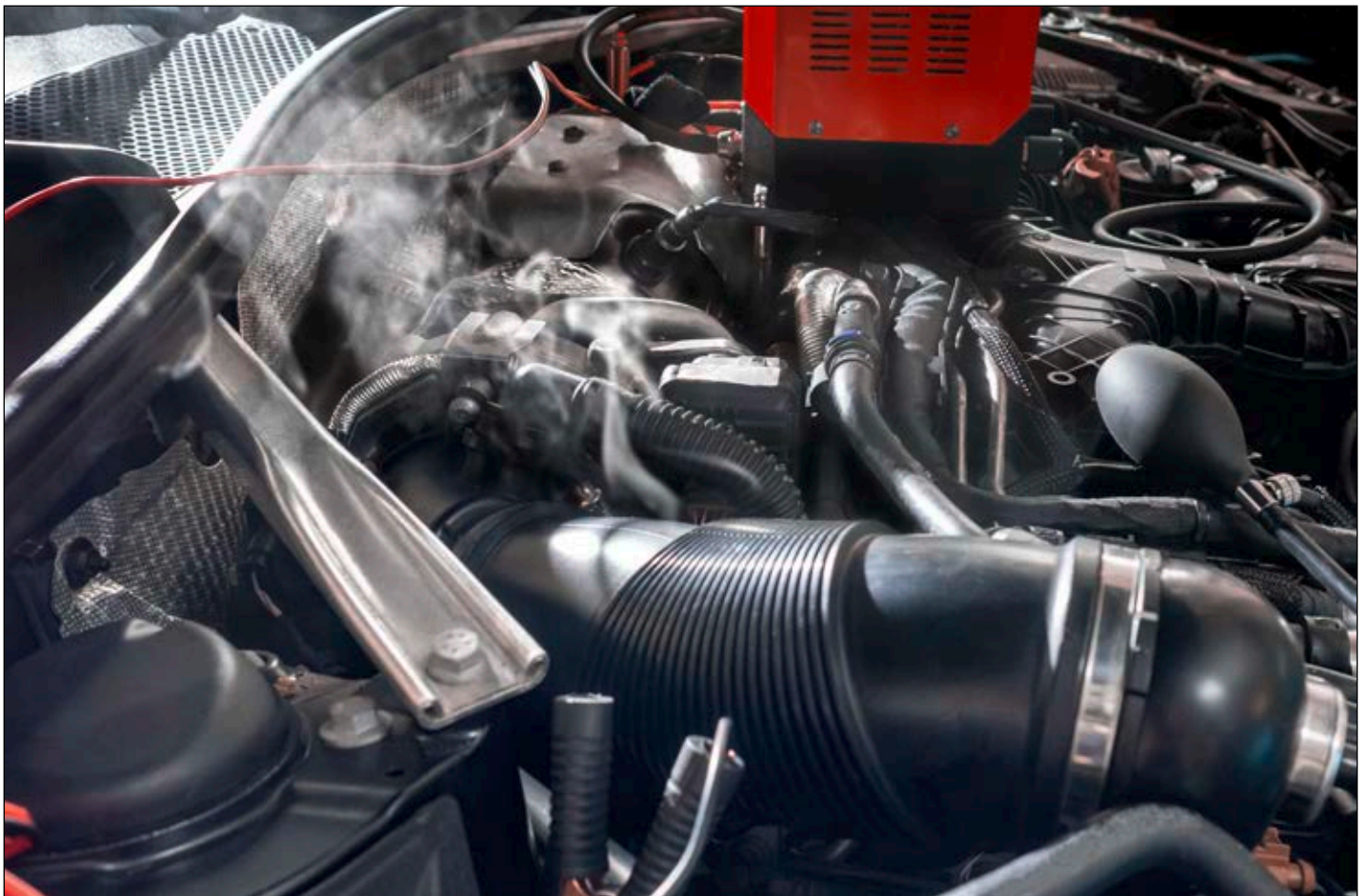



V4326N, EAN 4047728079860
Measuring cable set



257



V7002/4, EAN 4047728079815
Spark plug socket set



260



V1963/28, EAN 4047728081467
Cooling system diagnosis set



264

Overview of new products



V5932, EAN 4047728079617
Impact socket · long



297

V5933/3, EAN 4047728079624
Impact socket set · extra long



298

V4891-1.0, EAN 4047728080217
Induction heater



310







Tool trolleys and factory equipment

Tool trolleys with assortment	29–45
Mobile work bench with assortment	46–47
Tool trolleys without assortment	48–53, 56
Mobile work bench without assortment	54–55
Service trolley	57
Accessories for tool trolleys	58–65
Storage system	67–78
Accessories for storage system	79–89

VIGOR No:	h x w x d mm	Total loading capacity kg	Worktop	Insert size	Insert dimension mm	Number of drawers	Loading capacity per drawer kg	Drawer slide-out	Drawer lock	
V5489		1000x677x459	400	Removable foam mat	L	563x393	7	20	100%	Central locking
V1901		1000x723x459	500	Solvent resistant plastic material	L	563x393	7	25	100%	Central locking
V4481		1000x907x481	500	Solvent resistant plastic material	XL	750x393	8	25	100%	Central locking
V4481-X		1017x940x514	500	Stainless steel worktop	XL	750x393	8	25	100%	Central locking
V4481-XXL		1017x1625x695	1000	Stainless steel worktop	XD	790x570	13	30	100%	Central locking
V4481-XD		1017x986x695	500	Stainless steel worktop	XD	790x570	8	30	100%	Central locking
V4813		1000x1091x481	1000	Wooden worktop with collecting groove	L	563x393	8	40	100%	Central locking
V4814		1000x907x481	1000	Wooden worktop with collecting groove	XL	750x393	4	40	100%	Central locking

Tool trolleys with assortment



V2379N, EAN 4047728055444



Tool trolley with assortment and mat



Drawer equipment variants:

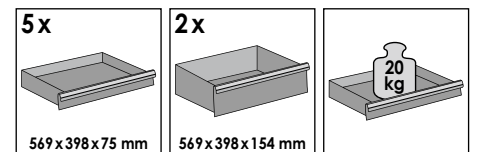
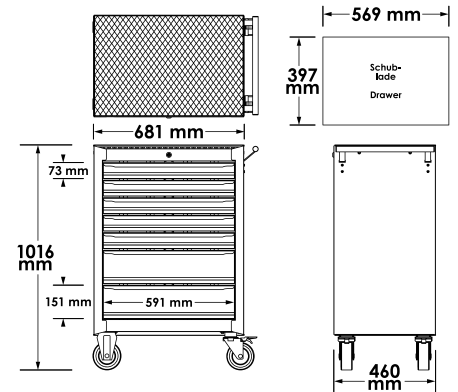

+ assortment

V5116



V6726



V5111N



V2712N, EAN 4047728055451



Tool trolley with assortment and mat



Drawer equipment variants:

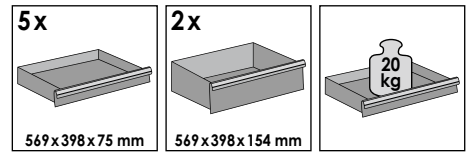
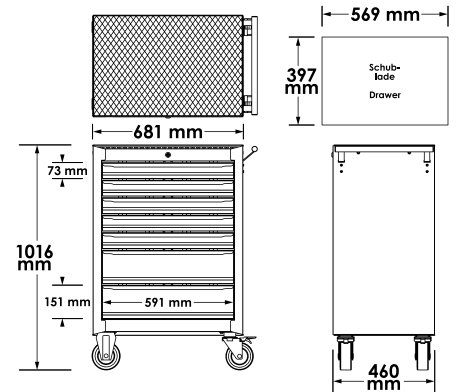

+ assortment

V5116



V2837

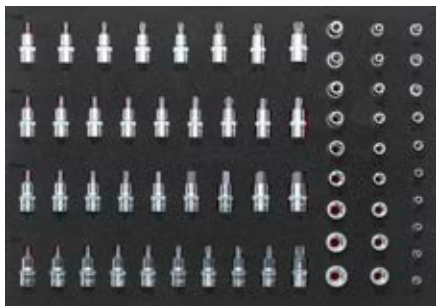

V6726

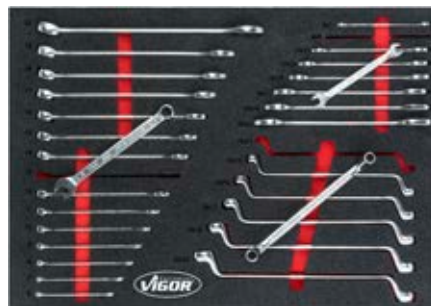

V5111N



Tool trolleys with assortment



V4219, EAN 4047728042192



Tool trolley with assortment and plastic worktop

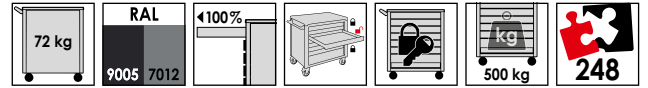

Drawer equipment variants:

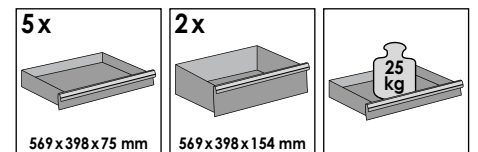
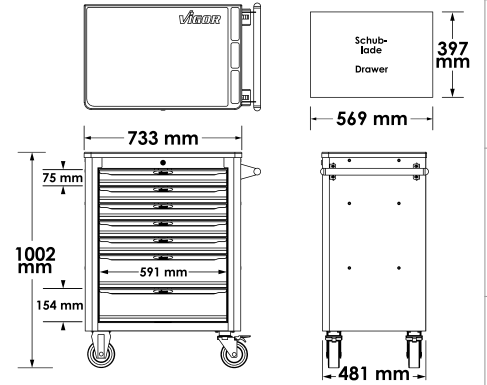

+ assortment

V6643



V4188



V5634N



V1901/376, EAN 4047728080293

VIGOR
SERIES **L**

Tool trolley with assortment
and plastic worktop

NEW

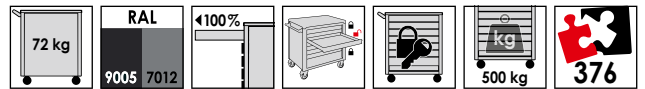

Drawer equipment variants:

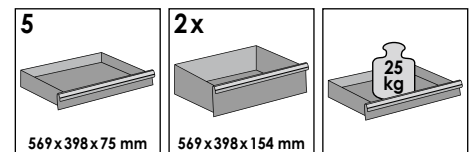
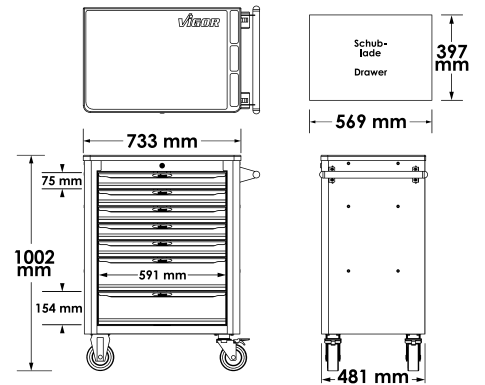

+ assortment

V4188



V4753

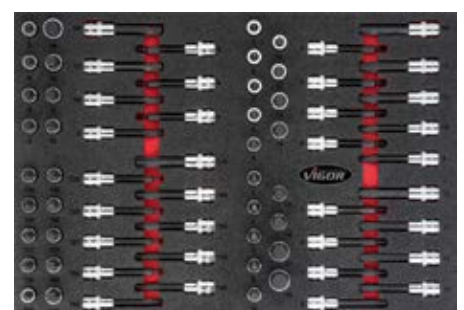

V6724



V5068



V5070

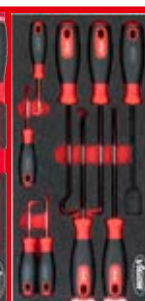

V5006



V5633N



V5603



V7324



Tool trolleys with assortment



V5055, EAN 4047728050562



Tool trolley with assortment and plastic worktop

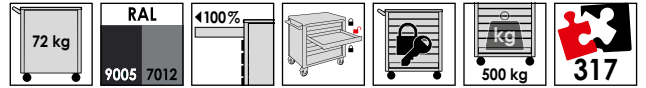

Drawer equipment variants:

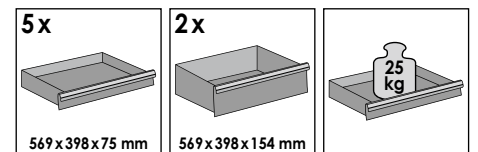
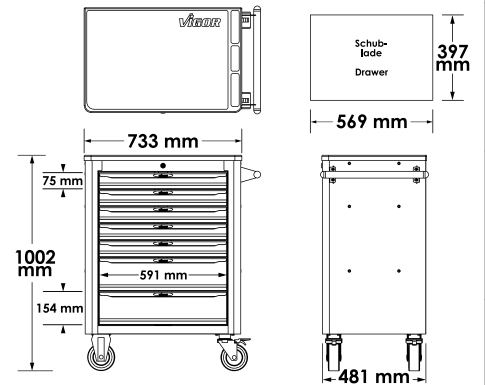

+ assortment

V4753

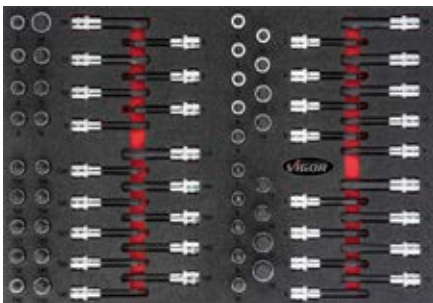

V6643



V4188



V5634N



V4560, EAN 4047728045605

VIGOR
SERIES **L**

Tool trolley with assortment and plastic worktop

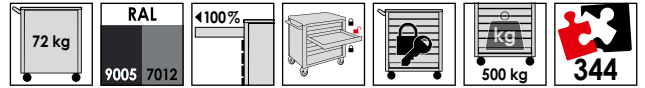

Drawer equipment variants:

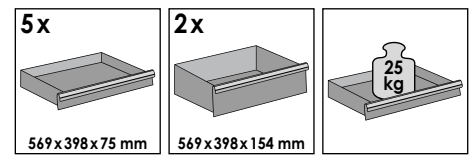
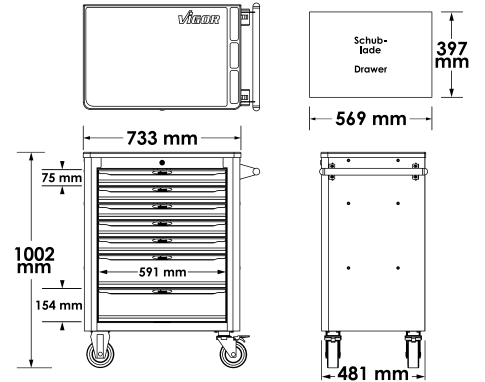

+ assortment

V4188



V2837

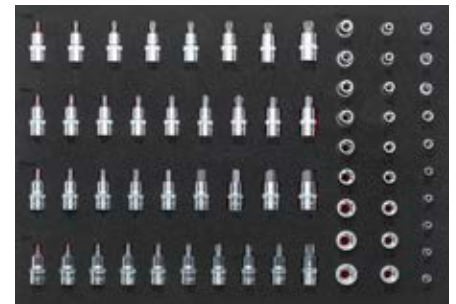

V4230



V5637N



V6643



Tool trolleys with assortment



V4561, EAN 4047728045810

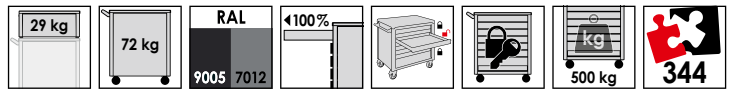

Tool trolley with assortment and tool chest with plastic worktop



Drawer equipment variants:

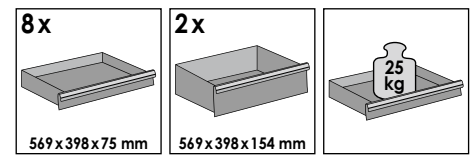
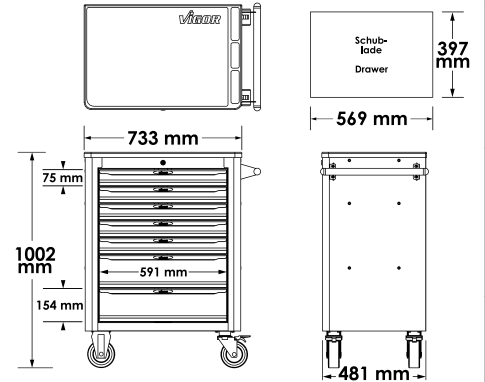

+ assortment

V4188



V2837

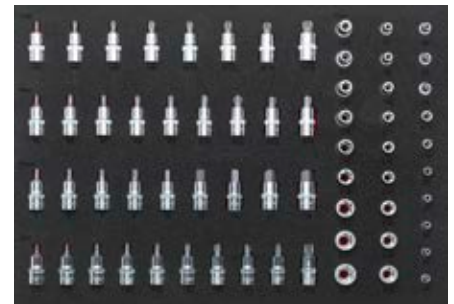

V4230



V6643



V5637N



V4542, EAN 4047728045421

VIGOR
SERIES **XL**

Tool trolley with assortment and plastic worktop

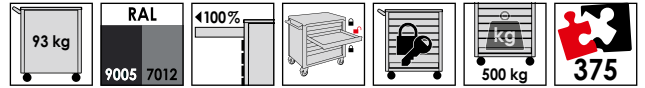

Drawer equipment variants:

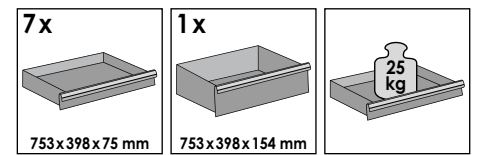
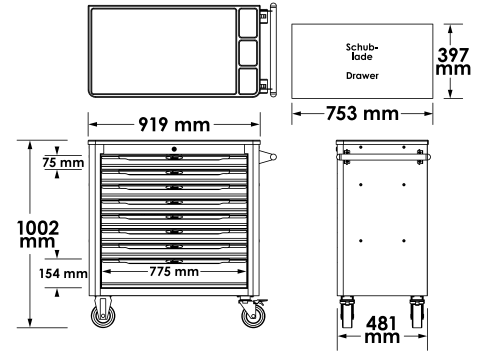

+ assortment

V4586



V6650



V5170



V5638N



Tool trolleys with assortment



V5434, EAN 4047728054348



Tool trolley with assortment and plastic worktop

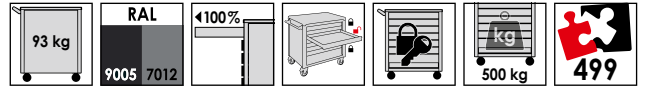

Drawer equipment variants:

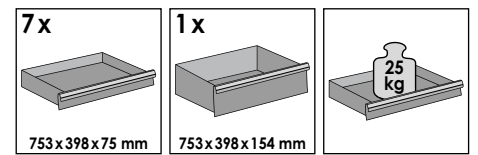
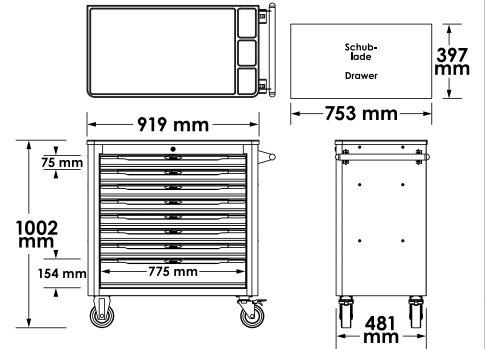

+ assortment

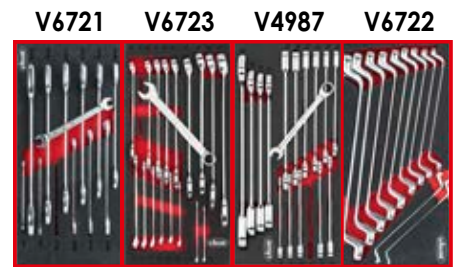
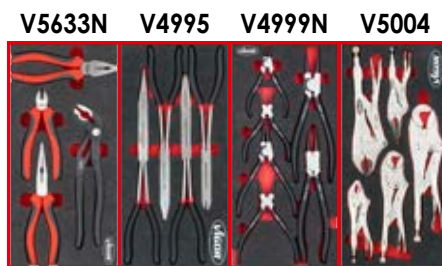
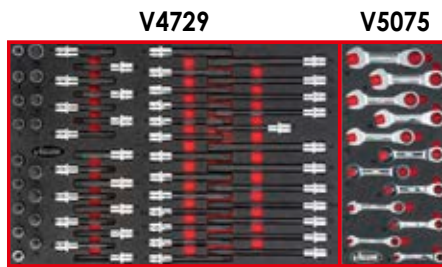
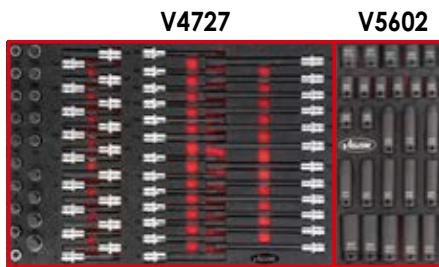

V4481-X/375, EAN 4047728062350

VIGOR
SERIES **XL**

Tool trolley with assortment and stainless steel worktop

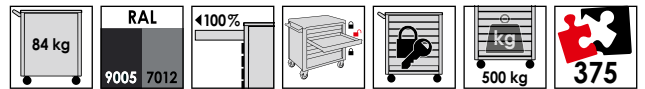

Drawer equipment variants:

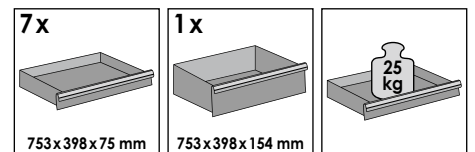
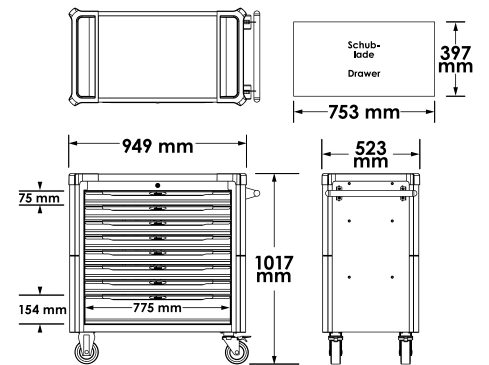

+ assortment

V4586



V6650



V5170



V5638N



Tool trolleys with assortment



V4481-X/466, EAN 4047728074674



Tool trolley with assortment and stainless steel worktop

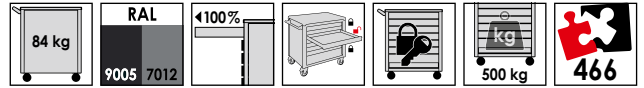

V2393-S

Drawer equipment variants:

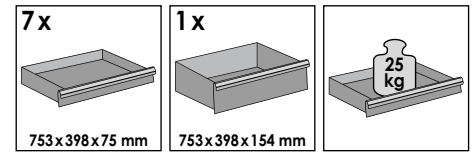
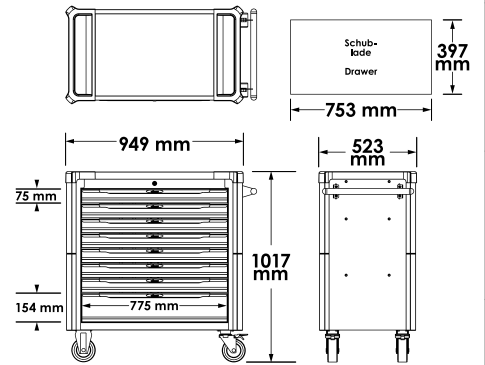

+ assortment

V6394



V4586



V5170



V6015



V6650



V7015N



V4481-X/499, EAN 4047728062367

VIGOR
SERIES **XL**

Tool trolley with assortment and stainless steel worktop

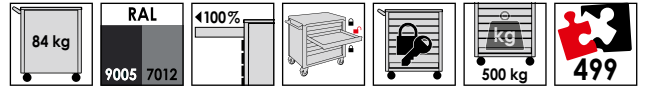

Drawer equipment variants:

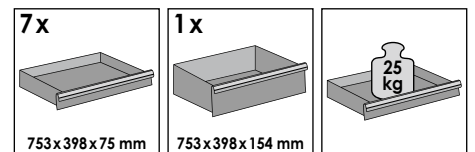
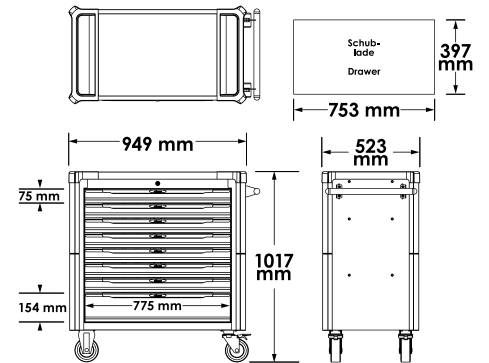

+ assortment

V4971 V4973 V4975 V7323

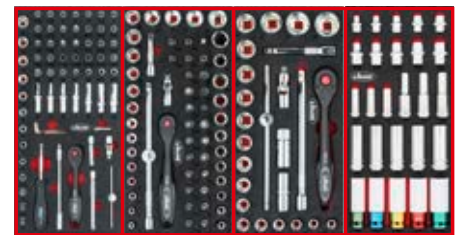

V4727

V5602



V4729

V5075



V6721

V6723

V4987

V6722

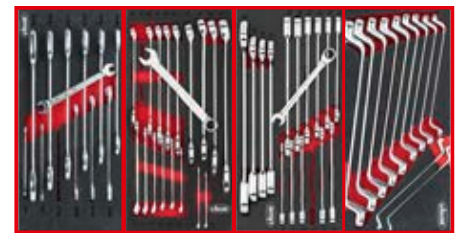

V5170

V5633N

V4995

V4999N

V5004

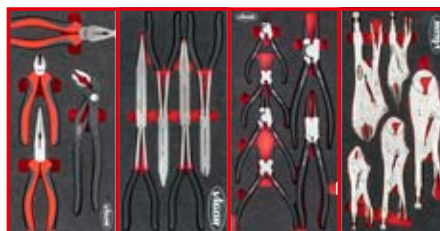

V5006

V5017

V5070

V5072



Tool trolleys with assortment

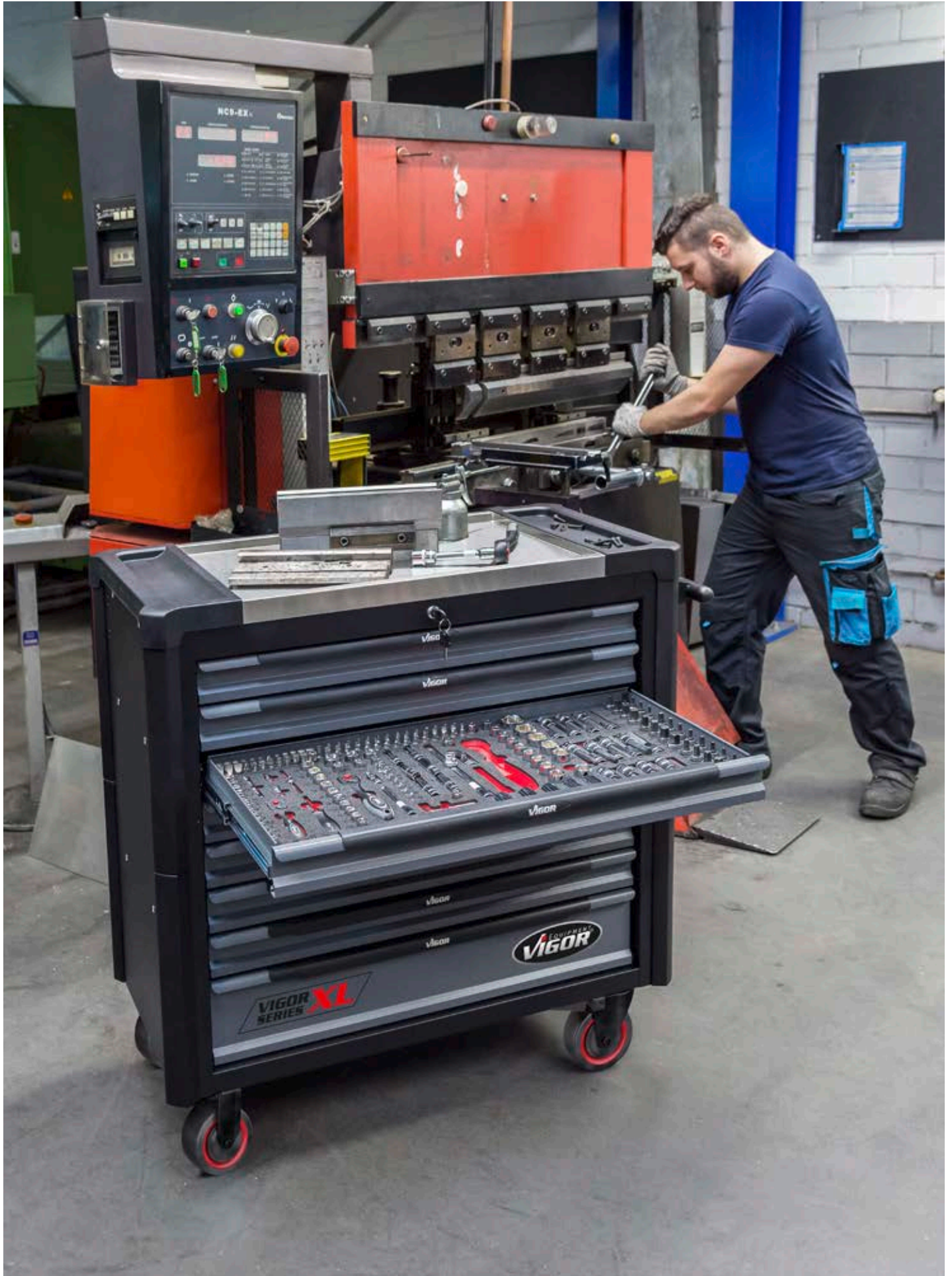

V4481-XD/469, EAN 4047728068512

VIGOR
SERIES **XD**

Extra-deep tool trolley with assortment and stainless steel worktop

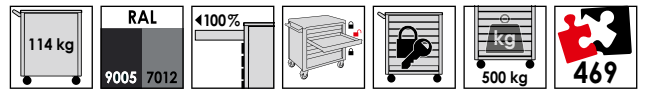

Drawer equipment variants:

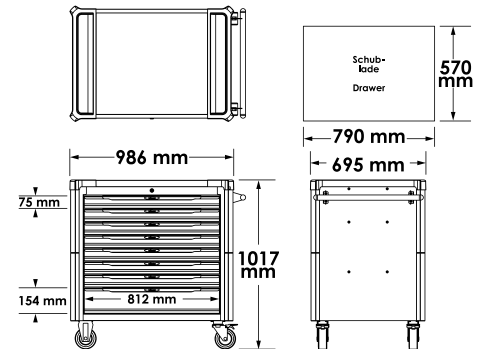

V4481 - EXTRA DEEP

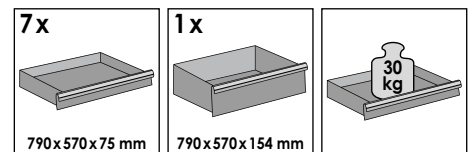

+ assortment

V6821



V6822N



V6807



V6808



V6813



V6814



V6815N

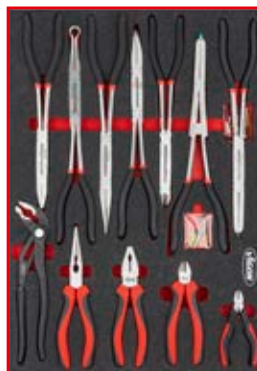

V6816

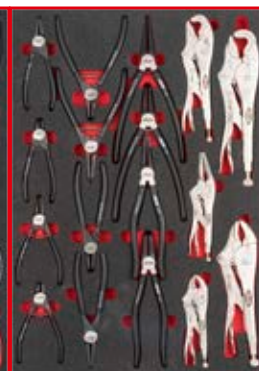

Tool trolleys with assortment



V4481-XD/775, EAN 4047728068529



Extra-deep tool trolley with assortment and stainless steel worktop

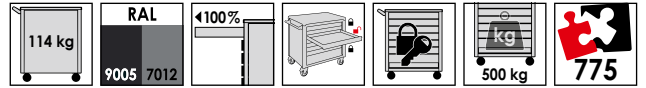

Drawer equipment variants:

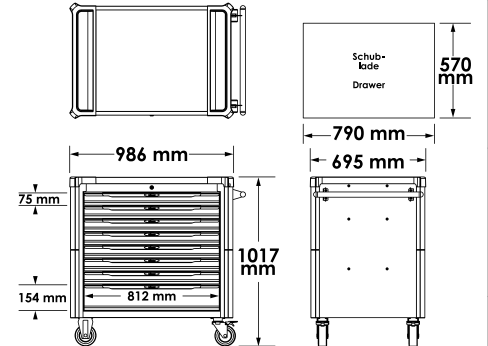

V4481 - EXTRA DEEP

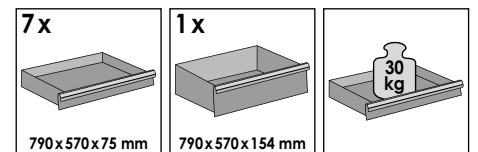

V6821 V6822

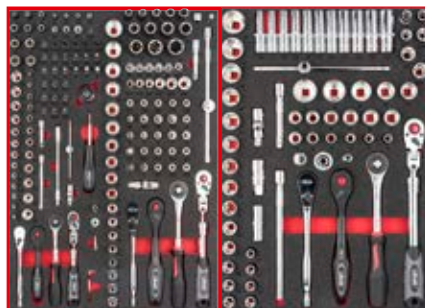

+ assortment

V6809 V6810

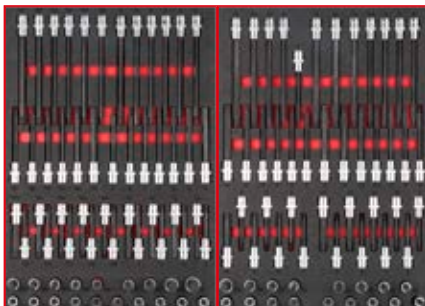

V6807 V6808

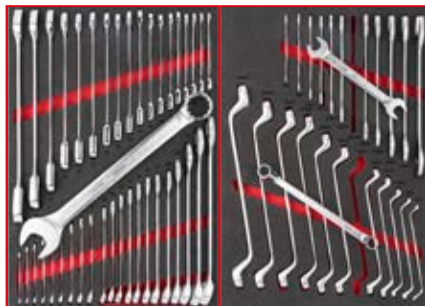

V6813 V6814



V6815 V6816N

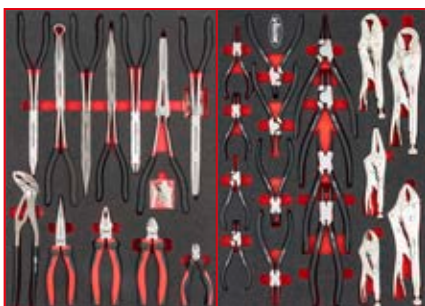

V6817 V6818

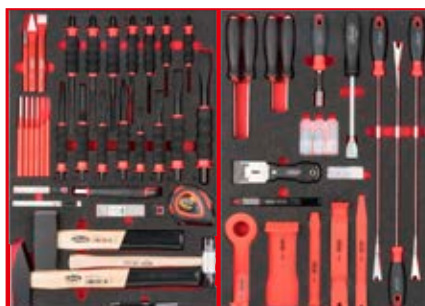

V6811 V6812

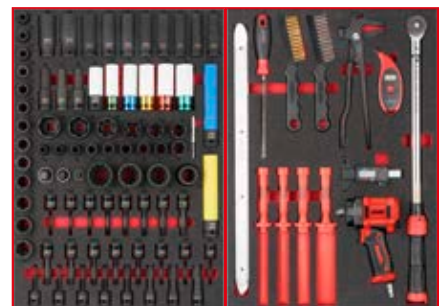

V4481-XXL/929, EAN 4047728082303

VIGOR
SERIES **XXL**

Extra-deep, extra-wide tool trolley with assortment and stainless steel worktop

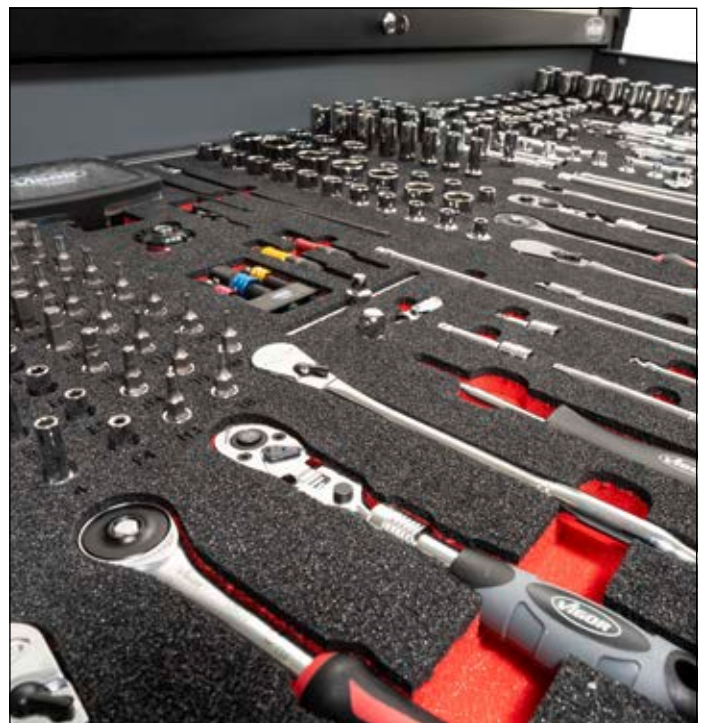

Tool trolleys with assortment



NEW

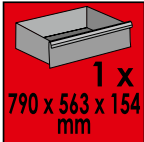
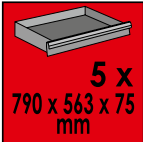
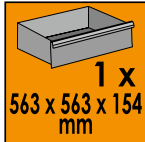
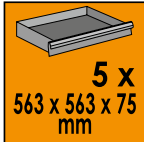
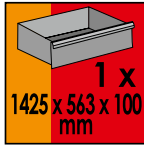
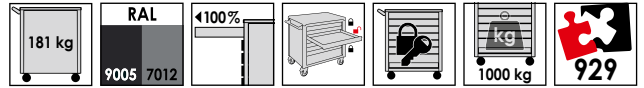

Drawer equipment variants:

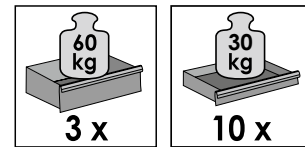
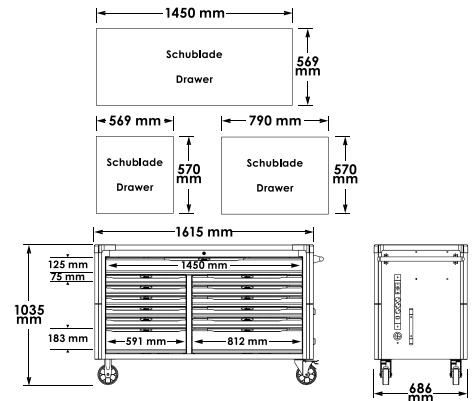

+ assortment

V6830

V6831

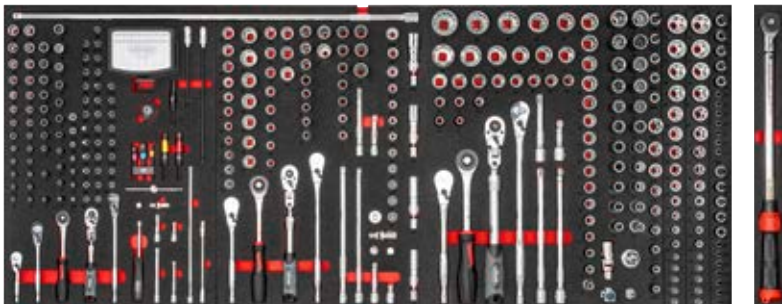

V6807

V6808

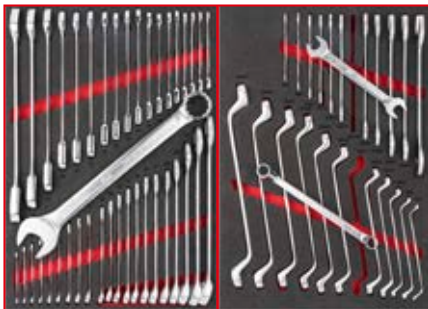

V6813

V6814



V2393-XD



V6809

V6810

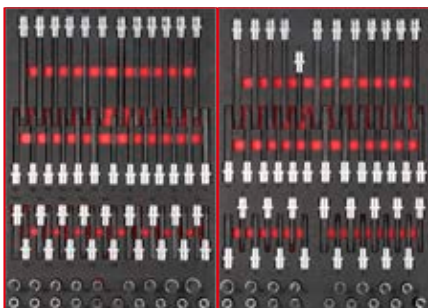

V6815

V6811



V6817

V6818

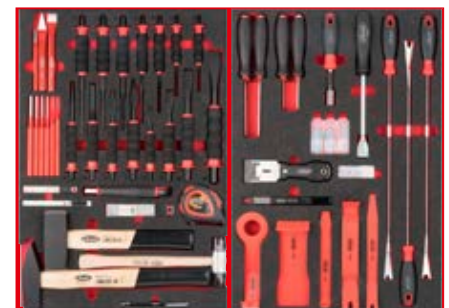

V5156, EAN 4047728051569

VIGOR
SERIES **L**

Mobile work bench with assortment and wooden board

• Delivery without pull-handle

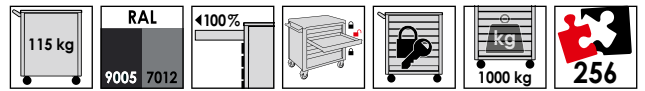

Drawer equipment variants:

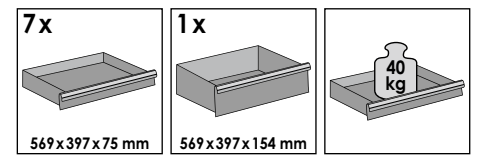
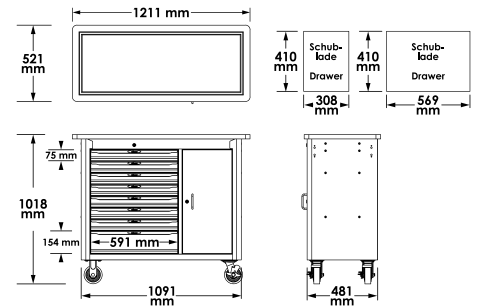

+ assortment

V4188



V6643



V4230



V5636N



Mobile work bench with assortment



V5158, EAN 4047728051583



Mobile work bench with assortment and wooden board

• Delivery without pull-handle

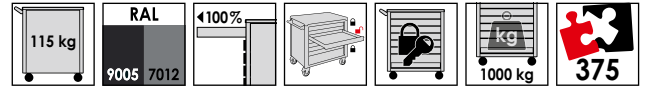

Drawer equipment variants:

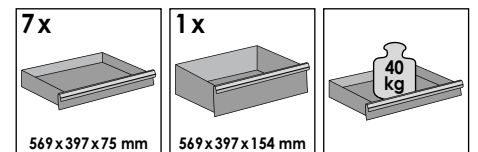
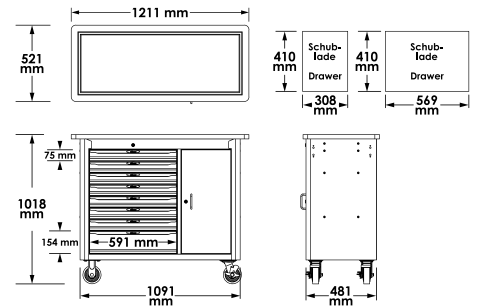

+ assortment

V4188



V4727

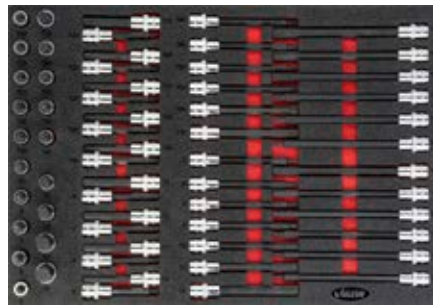

V4729

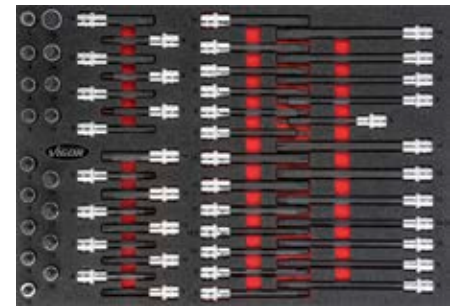

V6643



V4230



V5636N



V5489, EAN 4047728054898

VIGOR
SERIES **M**

Tool trolley without assortment, with foam mat

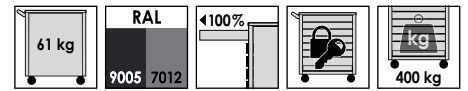

Drawer equipment variants:

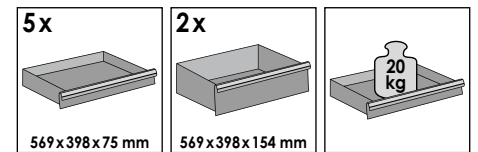
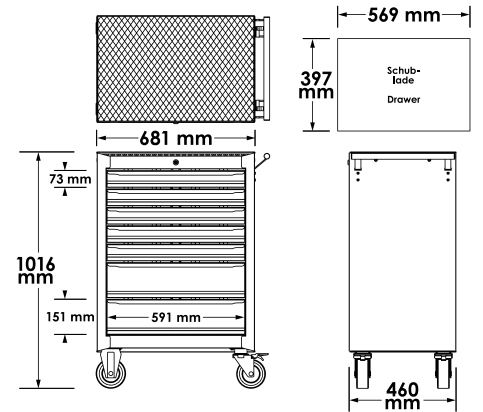

Tool trolleys without assortment



V1901, EAN 4047728019019



Tool trolley without assortment, with plastic worktop

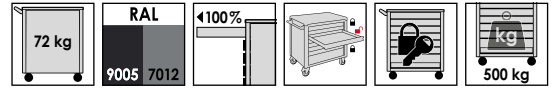

Drawer equipment variants:

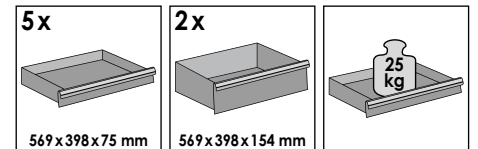
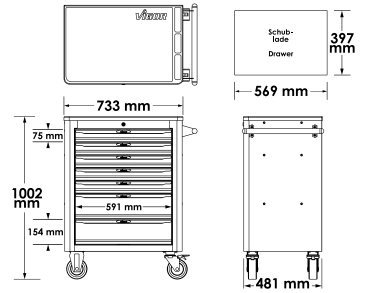

V1902, EAN 4047728019026



Tool chest for tool trolley V1901

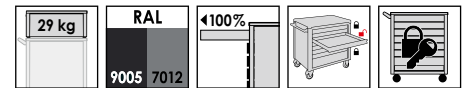

Drawer equipment variants:

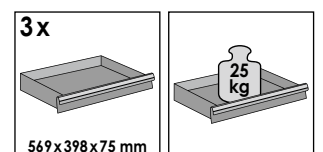
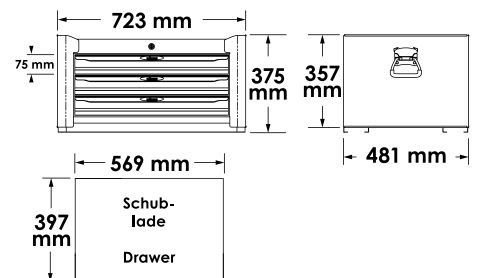

- Delivery without plastic cover, see V1909 -



V1970, EAN 4047728019705

VIGOR
SERIES **L**

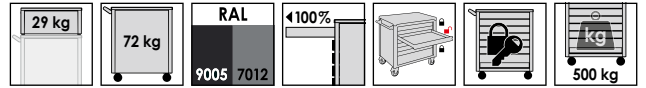

Tool trolley including tool chest without assortment, with plastic worktop

Drawer equipment variants:

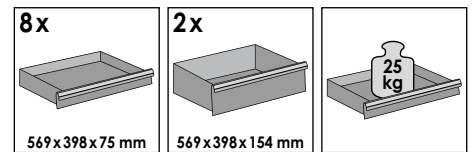
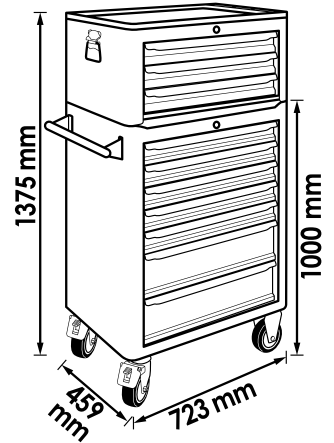

Tool trolleys without assortment



V4481, EAN 4047728044813



Tool trolley without assortment, with plastic worktop

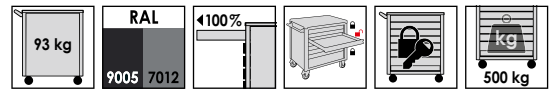

Drawer equipment variants:

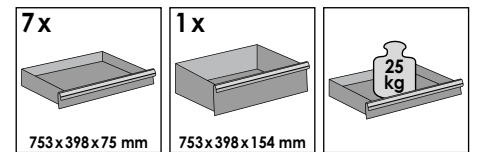
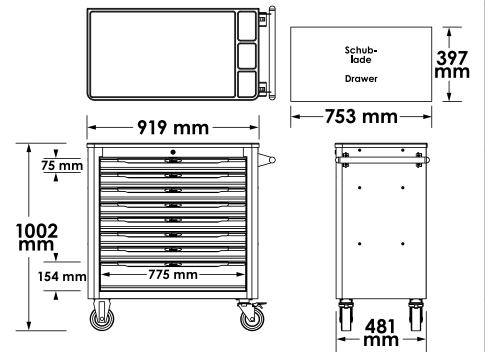

V4481-X, EAN 4047728060721

VIGOR SERIES XL

Tool trolley without assortment, with stainless steel worktop

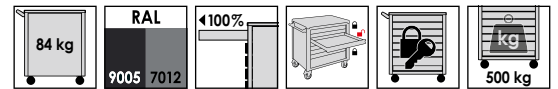

Drawer equipment variants:

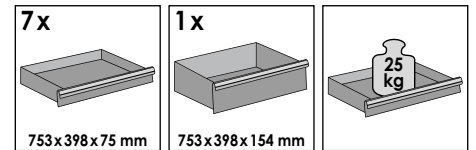
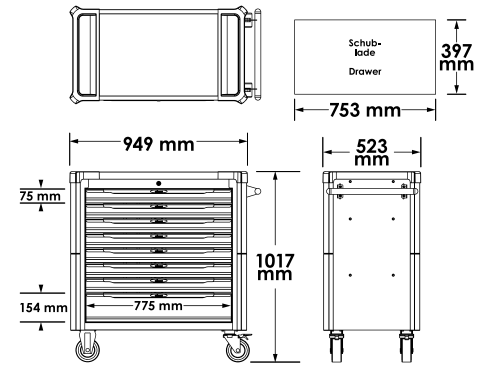

Tool trolleys without assortment



V4481-XD, EAN 4047728066488



Extra-deep tool trolley without assortment, with stainless steel worktop



V4481 - EXTRA DEEP

114 kg	RAL 9005 7012	1100%			500 kg
--------	---------------	-------	--	--	--------

Drawer equipment variants:

S	S	M	M	L	L
S	S	M	M	L	L

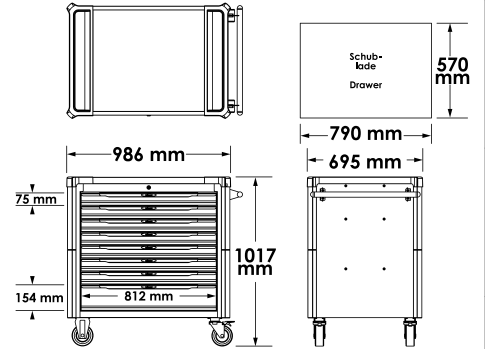

7x 790x570x75 mm	1x 790x570x154 mm	 30 kg
-------------------------	--------------------------	-----------

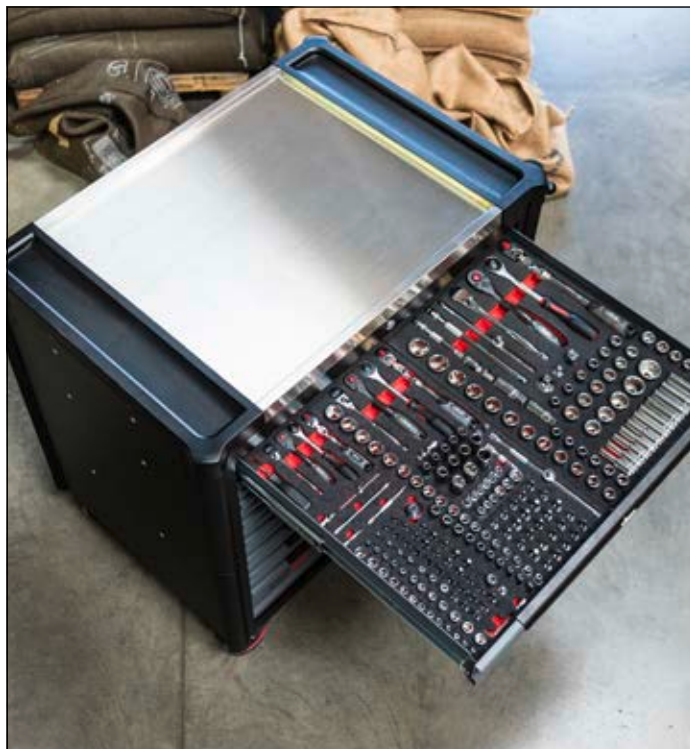

-
-
-
-
-
-
-
-
-
-
-
-
-

V4813, EAN 4047728048132



Mobile work bench without assortment, with wooden board

• Delivery without pull-handle

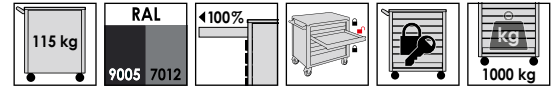

Drawer equipment variants:

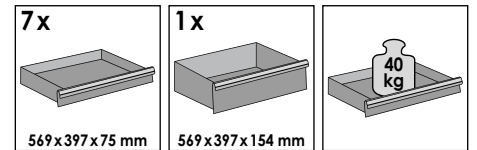
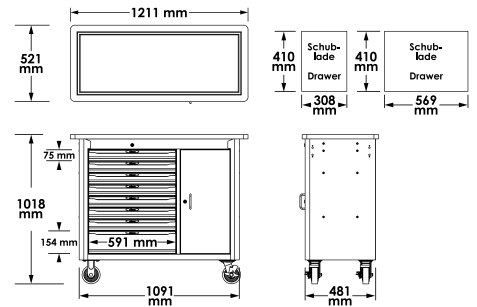

Mobile work bench without assortment



V4814, EAN 4047728048149



Mobile work bench without assortment, with wooden board

• Delivery without pull-handle

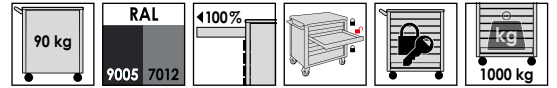

Drawer equipment variants:

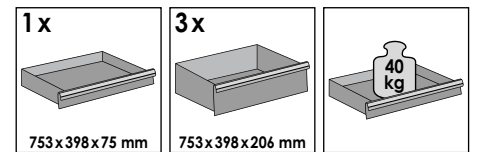
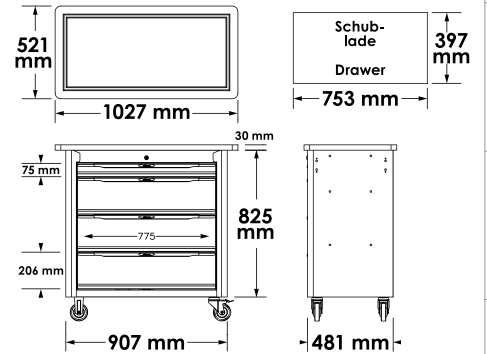

V4481-XXL, EAN 4047728080491

VIGOR SERIES XXL

Extra-deep, extra-wide tool trolley without assortment, with stainless steel worktop

NEW

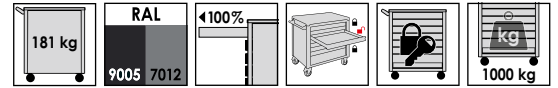

Drawer equipment variants:

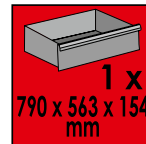
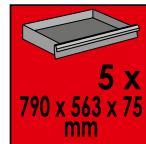
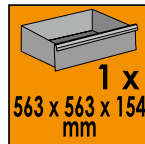
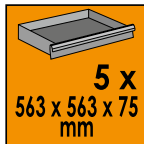
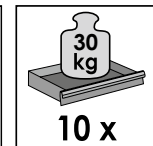
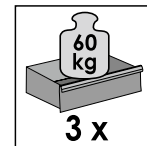
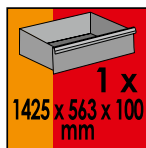
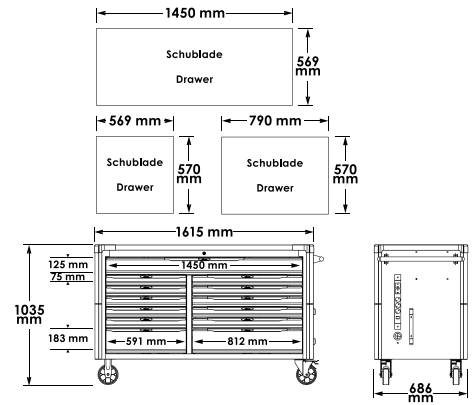

Service trolley



V4758, EAN 4047728**047586**

Service trolley

- Robust sheet-steel design (1 mm strong intermediate plates and 1.5 mm strong angle elements)
- Middle level adjustable in height by 30 mm in 7 stages, for containers, for example
- Loading capacity per tray: 40 kg
- Large ball-bearing wheels (Ø 100 mm), 2 swivel castors, 2 fixed castors
- Easy manoeuvrability, even with high dynamic load
- Sturdy handle, firmly attached to the trolley's corpus
- Weight: 19 kg

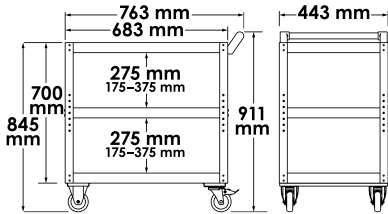

VIGOR No.	Designation		EAN 4047728+
V5180	Swivel castor (pair) · for service trolley V4758	2	051804
V5191	Fixed castor (pair) · for service trolley V4758	2	051910



V6398, EAN 4047728**071314**

Laptop holder · rotatable and pivotable

- Suitable for all series since 07/2019 → (with four screw sleeves)
- Pivotable and lockable
- 360° rotation
- Frontal and lateral edging protects the device from falling
- The work surface can be adjusted to the desired inclination
- Four additional holes for passing cables

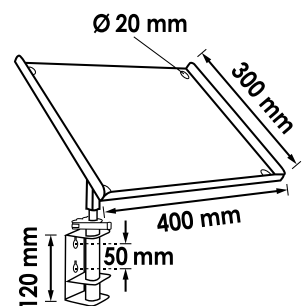

V6221, EAN 4047728062213

Laptop table

- Additional storage space for laptops, tablets, tools or motor vehicle components
- Suitable for all series
- Can be expanded and collapsed when installed
- Expansion of the tool trolley surface for better organisation and overview while working
- Locking element prevents unintentional folding of the table
- Maximum permitted loading capacity: 25 kg



Screwed locking element

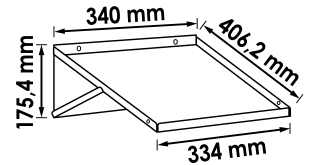

V6395, EAN 4047728070522

Waste bin

- Disposal of waste or cloths
- Suitable for all series
- Also suitable for storing tools
- Capacity: 20 l

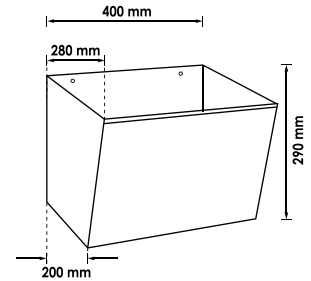

V6396, EAN 4047728069601

Screwdriver holder

- Quick access to screwdrivers directly on the tool trolley
- Suitable for all series
- For 12 screwdrivers

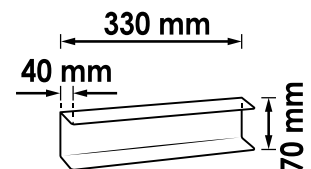

V6394, EAN 4047728069595

Impact wrench holder

- Putting an impact wrench down directly on the tool trolley
- Suitable for all series since 07/2019→ (with four screw sleeves)
- Plastic edge protection prevents scratches when inserting the impact wrench
- Suitable for impact wrenches

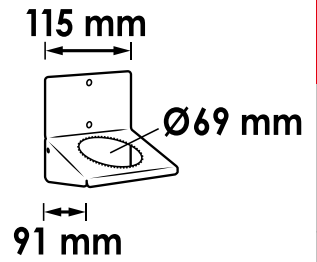

V6689, EAN 4047728079419

Handle rail for tool trolley and VSS lower cabinets

- Replacement handle rail with Vigor logo
- Suitable for all Series L, Series XL and Series XD tool trolleys as well as all VSS base cabinets



NEW



V2397, EAN 4047728023979

Holder for paper reel

- Paper reels can be hung directly at the workplace
- Suitable for all series
- Paper reel not included
- Maximum width of paper reel: 370 mm

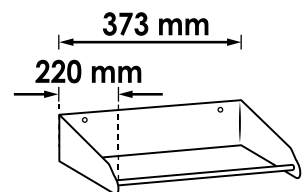
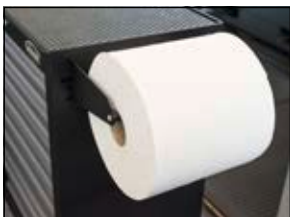

V6397, EAN 4047728069793

Holder for paper reel · pivotable

- Paper reels can be hung directly at the workplace
- Suitable for all series
- Paper reel not included
- Maximum width of paper reel: 320 mm

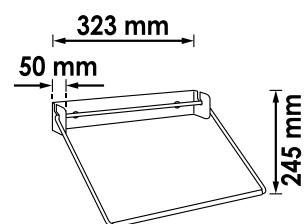

Document holder

- Storing of clipboards or order pockets directly at the workstation
- Suitable for all series
- Optimum storage of documents or workshop documents directly at the workplace



VIGOR No.	Designation	LxWxH mm	EAN 4047728+
V6393-S	Document holder · small · floor depth 43 mm	340x70x156	069205
V6393	Document holder · large · floor depth 100 mm	340x146x176	069519

Can holder

(without cans)



VIGOR No.	Designation	EAN 4047728+
V2393	Can holders · for Series M · Series L · Series XL · Series XD (except V4481-X) · up to 5 cans	023931
V2393-S	Can holder · short · for all series · up to 4 cans	062046
V2393-XD	Can holder · extra long · for Series XD · up to 6 cans	067614

Compartment for small pieces



VIGOR No.	Designation	EAN 4047728+
V4481-X-4	Compartment for small pieces · V4481-X	073639
V4481-XD-4	Compartment for small pieces · V4481-XD	073646



Accessories for tool trolleys



Separation sheet set

- Sorting of small parts in tool trolleys or storage system lower cabinets
- All four separation sheet sizes compatible with the separation sheet set
- Separation sheets can be inserted into each other thanks to asymmetrical punching
- Hot-dip galvanized surface prevents rust formation

MADE IN GERMANY

XD

XL

L

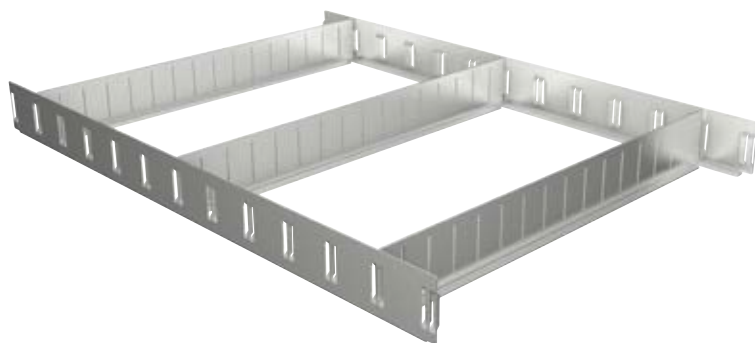

192 partitions possible

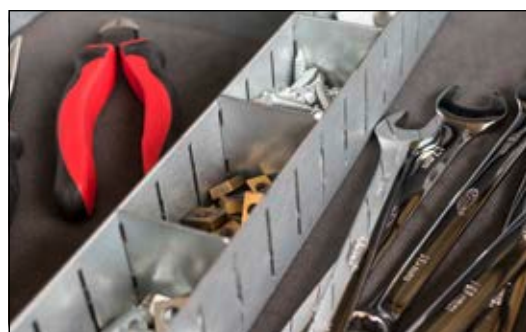

VIGOR No.	Designation	XX	EAN 4047728+
V6688	Separation sheet set, series M and series L	5	070249
V6688-XL	Separation sheet set, series XL	6	070096
V6688-XD	Separation sheet set, series XD	6	070089
V6688H	Separation sheet set, High Series M and Series L	5	080958
V6688H-XD	Separation sheet set, High Series XD	5	081009
V6688H-XL	Separation sheet set, High Series XL	5	081580

Separation sheet set

- Compatible with all separation sheet sets and cross members
- For partitioning within a column

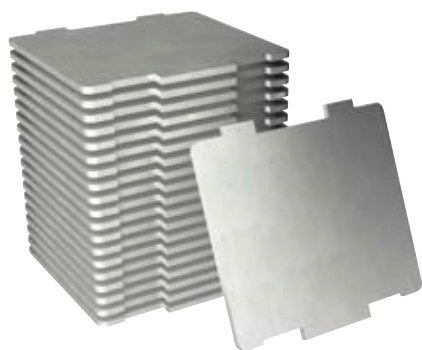

4 different separation sheet lengths – can be used for all systems

MADE IN GERMANY

VIGOR No.	Designation	XX	EAN 4047728+
V6685-1/20	Separation sheet set · small 45 mm	20	070133
V6685-2/20	Separation sheet set · medium 91 mm	20	070126
V6685-3/10	Separation sheet set · large 137 mm	10	070119
V6685-4/10	Separation sheet set · extra large 183 mm	10	070102
V6685H-2/20	High divider plate set · medium 91 mm	20	080989
V6685H-3/10	High divider plate set · large 137 mm	10	081511
V6685H-4/10	High divider plate set · extra large 183 mm	10	080996

Cross member set

- Hot-dip galvanized surface prevents rust formation



More stability and hold thanks to splayed edges

MADE IN GERMANY

VIGOR No.	Designation	XX	EAN 4047728+
V6687/5	Cross member set for Series XD	5	070072
V6686/5	Cross member set for series M · series L and series XL	5	070065
V6685H/5	High cross member set for Series M · Series L and Series XL	5	080972
V6687H/5	Cross member set for Series XD	5	080965



Fixed castor



VIGOR No.	Designation		EAN 4047728+
V1907	Fixed castor · for tool trolleys Series M · Series L · Series XL · Series XD	1	019071
V4814-3	Fixed castor (pair) · for tool trolleys Series XL · Series XL Special and work benches	2	053044
V5191	Fixed castor (pair) · for service trolley V4758	2	051910

Swivel castor with locking brake



VIGOR No.	Designation		EAN 4047728+
V1908	Swivel castor · for tool trolleys Series M · Series L · Series XL · Series XD	1	019088
V4814-2	Swivel castor (pair) · for tool trolleys Series XL · Series XL Special and work benches	2	053037
V5180	Swivel castor (pair) · for service trolley V4758	2	051804

Drawer · flat



VIGOR No.	Designation	LxWxH mm	EAN 4047728+
V5489-4	Drawer · flat · 569x398x75 mm · for Series M	589x398x75	055413
V1905	Drawer · flat · 569x398x75 mm · for Series L · V1901 · V1902 · work bench V4813	589x398x75	019057
V4112	Drawer · flat · 753x398x75 mm · for Series XL · Series XL Special	753x398x75	041126
V4481-XD-2	Drawer · flat · for Series XD	790x570x75	067812

Drawer · high



VIGOR No.	Designation	LxWxH mm	EAN 4047728+
V5489-3	Drawer · high · 569x398x154 mm · for Series M	589x398x154	055307
V1906	Drawer · high · 569x398x154 mm · for Series L · V1901 · work bench V4813	569x398x154	019064
V4111	Drawer · high · 753x398x154 mm · for Series XL	753x398x154	041119
V4814-1	Drawer · high · 741x397x206 mm · for Series XL Special	741x397x206	053020
V4481-XD-3	Drawer · high · for Series XD	790x570x154	067829

Accessories for tool trolleys



Locking system



VIGOR No.	Designation	EAN 4047728+
V2462	Spare lock for all VIGOR tool trolleys and work benches	024624
V1904	Locking system for all VIGOR work trolleys and work benches	019040

Guiding rails (pair)



VIGOR No.	Designation	XX	EAN 4047728+
V1903	Guiding rails (pair) - for Series L · Series XL	2	019033
V5489-1	Guiding rails (pair) - for Series M	2	055284
V4481-XD-1	Guiding rails (pair) - for Series XD	-	067805

Worktop · plastic



VIGOR No.	Designation	EAN 4047728+
V1909	Worktop 723 x 459 mm · plastic · for tool trolley and tool chest Series L	019095
V4122	Worktop 907 x 481 mm · plastic · for tool trolley Series XL	041225

Worktop · wood



VIGOR No.	Designation	EAN 4047728+
V4814-4	Worktop 1030 x 520 mm · wood · for mobile work bench series XL	053051
V4813-1	Worktop 1201 x 520 mm · wood · for tool trolley series L	053013



V5489-2, EAN 4047728055291

Foam mat

- For tool trolley Series M
- LxW: 670x450 mm

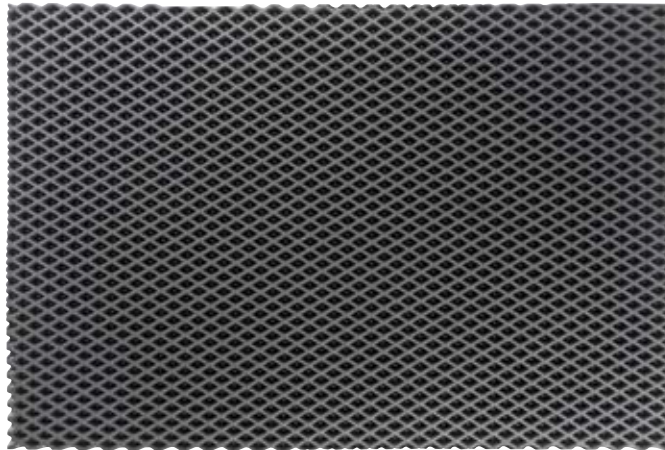

V4813-2, EAN 4047728059268

Storage shelf

- For work bench VIGOR V4813
- LxW: 400x450 mm



V5489-5, EAN 4047728075626

Pull-handle

- Easy manoeuvring of tool trolleys and work benches
- Handle · for tool trolleys · series M



V4893, EAN 4047728048934

Pull-handle

- Easy manoeuvring of tool trolleys and work benches
- Handle · for tool trolleys · series L and series XL



V4481-X-5, EAN 4047728075619

Pull-handle

- Easy manoeuvring of tool trolleys
- Handle · for tool trolleys · series XL · stainless steel



V4481-XD-5, EAN 4047728075602

Pull-handle

- Easy manoeuvring of tool trolleys
- Handle · for tool trolleys · series XD





Tool hook set

- Hanging of tools
- Use with tool cabinet V2532 and perforated tool panel plates V6000-05 - V6000-015

VIGOR No. V2517	mm 25	EAN 4047728+ 025171	VIGOR No. V2518	mm 100	EAN 4047728+ 025188	VIGOR No. V2519	mm 25	EAN 4047728+ 025195	VIGOR No. V2520	mm 100	EAN 4047728+ 025201

V6150, EAN 4047728060691

Vice

- Rotary disc
- Powder coated
- Jaw length 150 mm (6 inch)
- Thread depth 68 mm
- Clamping force 2.5 tonnes
- \pm 13.5 kg

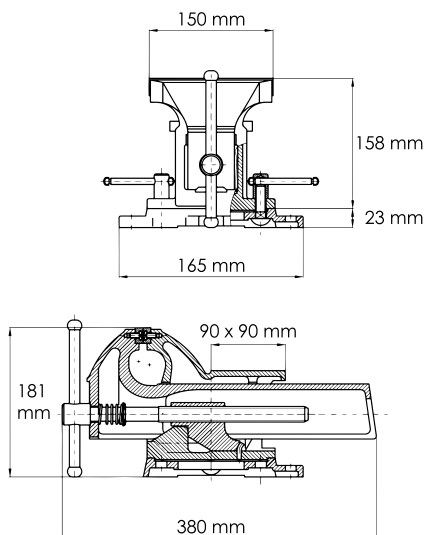

Maximum clamping depth
125 mm



120° pivotable

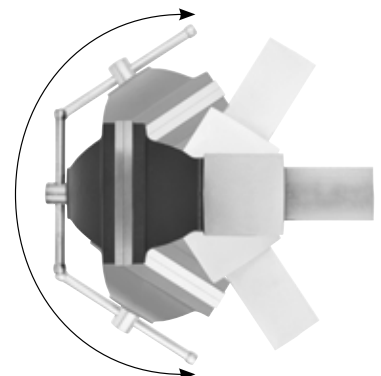

www.vigor-equipment.com/konfigurator

KONVIGORATOR



Technical information



Insert dimensions narrow
563x393 mm



Feet adjustable in height to 50 mm



Insert dimensions wide
750x393 mm



The installation material is included in delivery

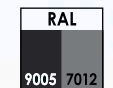

RAL colours 9005 · similar to 7012



Central locking

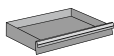

Narrow and flat drawer dimensions:
569x398x75 mm

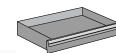

Wide and flat drawer dimensions:
753x398x75 mm

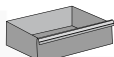

Narrow and high drawer dimensions:
569x398x154 mm



Wide and high drawer dimensions:
753x398x154 mm



Loading capacity of drawer: 25 kg

Storage system



V6000-3P1

Storage system

- 3-module combination in wide design
- Available with wooden or stainless steel worktop
- Including side veneer

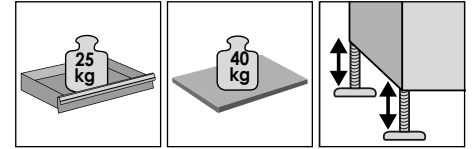
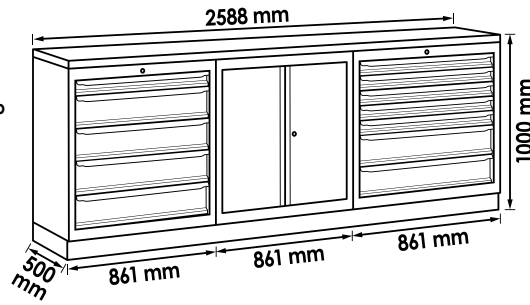

Starter kit



VIGOR No.	Designation	LxWxH mm	EAN 4047728+
V6000-3P1XL	Storage system combination · starter kit · wooden	2588x500x1000	073318
V6000-3P1XL-X	Storage system combination · starter kit · stainless steel	2588x500x1000	073271

All kits available with stainless steel or wooden worktops



V6000-3P2

Storage system

- 3-module combination in wide design with perforated panel structure and wall cabinets
- Available with wooden or stainless steel worktop
- Including side veneer

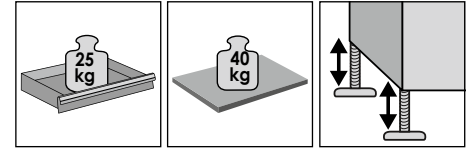
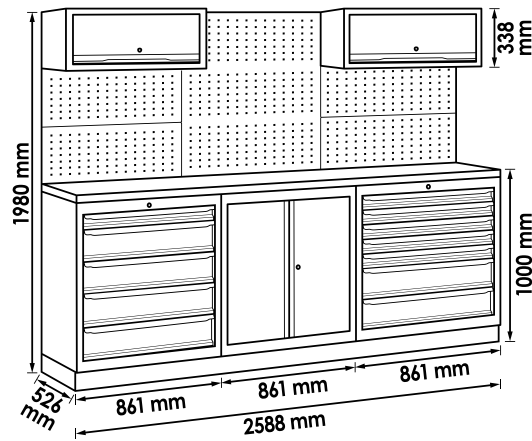

Complete kit



VIGOR No.	Designation	LxWxH mm	EAN 4047728+
V6000-3P2XL	Storage System combination · complete kit · wooden	2588 x 526 x 1980	073301
V6000-3P2XL-X	Storage System combination · complete kit · stainless steel	2588 x 526 x 1980	073295

Storage system



V6000-3

Storage system

- Cabinet door can be fitted on the right and left
- Cabinet door with magnetic lock
- Height-adjustable storage compartment
- All doors reinforced in the centre
- Simultaneous locking (equivalent to the Series L locking system)
- Drawer dimensions same as for Series L (569 x 398 x 75 mm flat drawer, 569 x 398 x 154 mm high drawer)
- Wall cabinets including high-quality shock absorbers
- Perforated tool panel for VIGOR tool hook sets V2517 · V2518 · V2519 · V2520

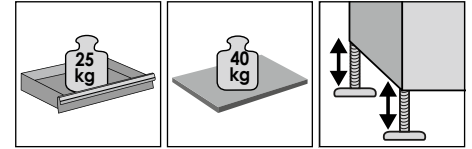
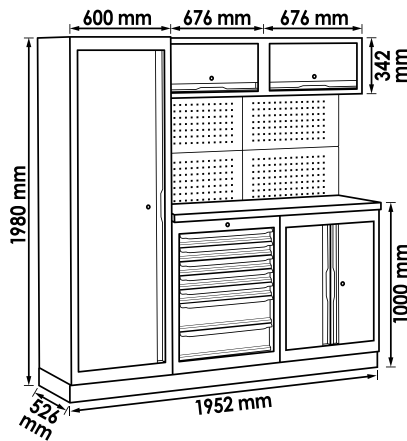

Compact kit



VIGOR No.	Designation	EAN 4047728+
V6000-3	Storage system combination · compact kit · wooden	048729
V6000-3-X	Storage system combination · compact kit · stainless steel	073288

V6000-029, EAN 4047728076975

Drawer lower cabinet · 2 drawers

- Setting up a stationary workstation
- Tidy storage of tool boxes and specialty tool cases
- Similar to Series L
- Upper drawer (HxWxD): 312x569x397 mm
- Lower drawer (HxWxD): 391x569x397 mm

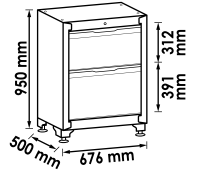
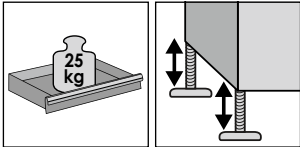

V6000-029XL, EAN 4047728076982

Drawer lower cabinet · 2 drawers

- Setting up a stationary workstation
- Tidy storage of tool boxes and specialty tool cases
- Similar to Series XL
- Upper drawer (HxWxD): 312x753x397 mm
- Lower drawer (HxWxD): 391x753x397 mm

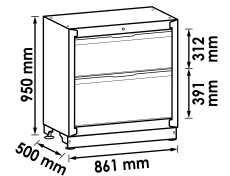
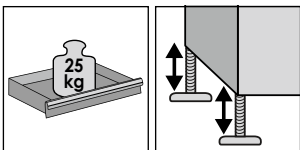

V6000-030, EAN 4047728070140

Drawer lower cabinet · 3 drawers

- Setting up a stationary workstation
- Clean storage of tools, small parts or various consumables
- To save space and for tidy organisation, we recommend VIGOR separation sheets or soft foam inserts
- Similar to Series L
- Dimensions (HxWxD)
1st - 3rd drawer: 75x569x398 mm

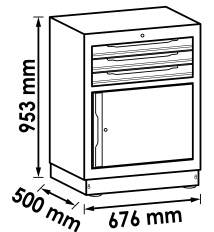
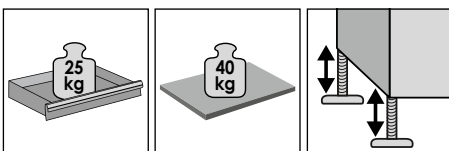

V6000-030XL, EAN 4047728070294

Drawer lower cabinet · 3 drawers

- Setting up a stationary workstation
- Clean storage of tools, small parts or various consumables
- To save space and for tidy organisation, we recommend VIGOR separation sheets or soft foam inserts
- Similar to Series XL
- Dimensions (HxWxD)
1st - 3rd drawer: 75x753x398 mm

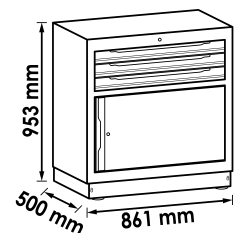
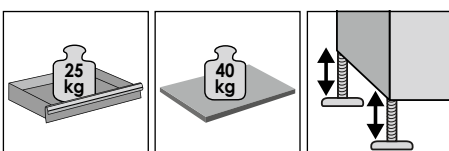

Storage system



V6000-031, EAN 4047728070157

Drawer lower cabinet · 5 drawers

- Setting up a stationary workstation
- Clean storage of tools, small parts or various consumables
- To save space and for tidy organisation, we recommend VIGOR separation sheets or soft foam inserts
- Similar to Series L
- Dimensions (HxWxD)
1st drawer: 75x569x398 mm
2nd – 5th drawer: 154x569x398 mm

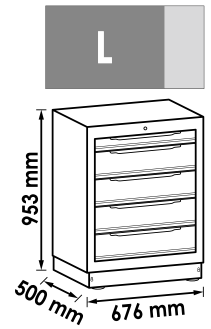
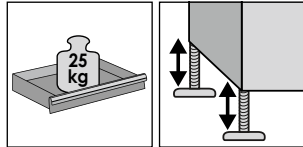

V6000-031XL, EAN 4047728070300

Drawer lower cabinet · 5 drawers

- Setting up a stationary workstation
- Clean storage of tools, small parts or various consumables
- To save space and for tidy organisation, we recommend VIGOR separation sheets or soft foam inserts
- Similar to Series XL
- Dimensions (HxWxD)
1st drawer: 75x753x398 mm
2nd – 5th drawer: 154x753x398 mm

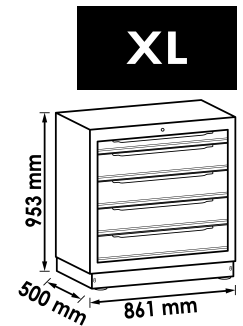
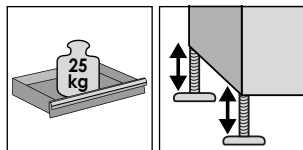

V6000-031XD, EAN 4047728081184

Drawer lower cabinet · extra deep · 5 drawers

- Setting up a stationary workstation
- Clean storage of tools, small parts or various consumables
- To save space and for tidy organisation, we recommend VIGOR separation sheets or soft foam inserts
- Similar to Series XD
- Dimensions (HxWxD)
1st drawer: 75x790x570 mm
2nd – 5th drawer: 154x790x570 mm

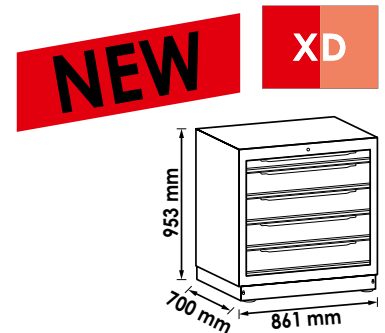
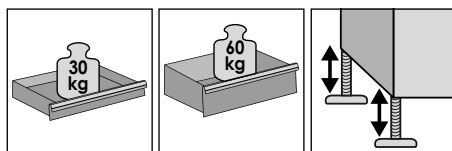

V6000-01, EAN 4047728048248

Drawer lower cabinet · 7 drawers

- Setting up a stationary workstation
- Clean storage of tools, small parts or various consumables
- To save space and for tidy organisation, we recommend VIGOR separation sheets or soft foam inserts
- Similar to Series L
- Dimensions (HxWxD)
1st - 5th drawer: 75x569x398 mm
6th - 7th drawer: 154x569x398 mm

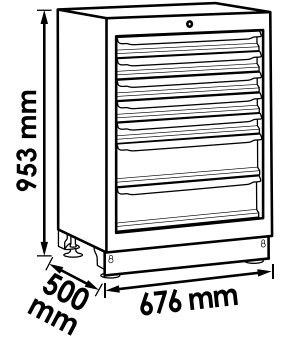
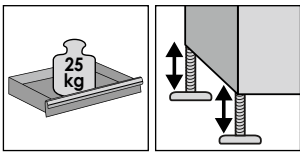

V6000-01XL, EAN 4047728070317

Drawer lower cabinet · 7 drawers

- Setting up a stationary workstation
- Clean storage of tools, small parts or various consumables
- To save space and for tidy organisation, we recommend VIGOR separation sheets or soft foam inserts
- Similar to Series XL
- Dimensions (HxWxD)
1st - 5th drawer: 75x753x398 mm
6th - 7th drawer: 154x753x398 mm

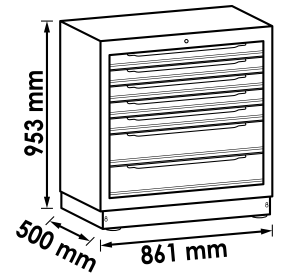
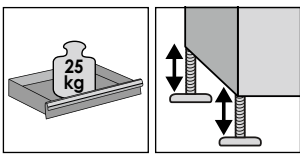

V6000-01XD, EAN 4047728081016

Drawer lower cabinet · extra deep · 7 drawers

- Setting up a stationary workstation
- Clean storage of tools, small parts or various consumables
- To save space and for tidy organisation, we recommend VIGOR separation sheets or soft foam inserts
- Similar to Series XD
- Dimensions (HxWxD)
1st - 5th drawer: 75x790x570 mm
6th - 7th drawer: 154x790x570 mm

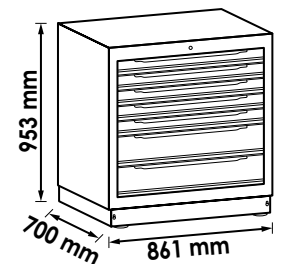
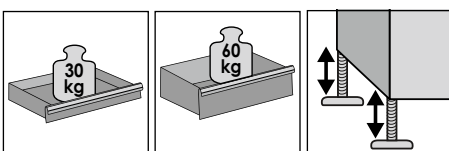

Storage system



V6000-019, EAN 4047728063883

Tool trolley for storage system · 7 drawers

- Space-saving storage of a tool trolley under the storage system worktop
- Especially for VIGOR storage system
- 4 swivel castors and special height for space-saving storage of the tool trolley after use under the storage system worktop
- Similar to Series L
- Dimensions (HxWxD)
1st - 5th drawer: 75x569x398 mm
6th - 7th drawer: 154x569x398 mm

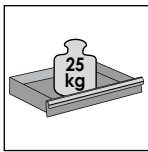

With 4 swivel castors

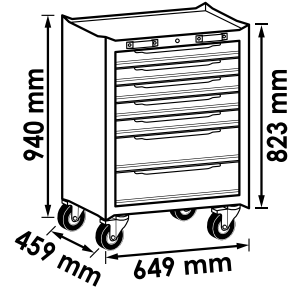

V6000-019XL, EAN 4047728070683

Tool trolley for storage system · 7 drawers

- Space-saving storage of a tool trolley under the storage system worktop
- Especially for VIGOR storage system
- 4 swivel castors and special height for space-saving storage of the tool trolley after use under the storage system worktop
- Similar to Series XL
- Dimensions (HxWxD)
1st - 5th drawer: 75x753x398 mm
6th - 7th drawer: 154x753x398 mm

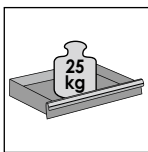

With 4 swivel castors

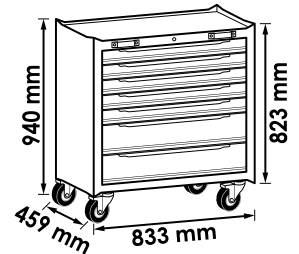

V6000-032, EAN 4047728070171

Drawer lower cabinet · 8 drawers

- Setting up a stationary workstation
- Clean storage of tools, small parts or various consumables
- To save space and for tidy organisation, we recommend VIGOR separation sheets or soft foam inserts
- Similar to Series L
- Dimensions (HxWxD)
1st - 7th drawer: 75x569x398 mm
8th drawer: 154x569x398 mm

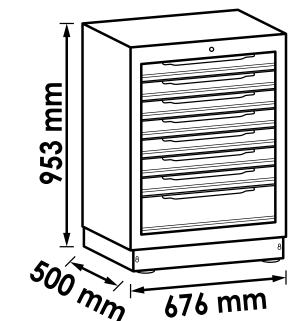
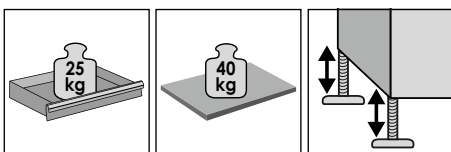

V6000-032XL, EAN 4047728070324

Drawer lower cabinet · 8 drawers

- Setting up a stationary workstation
- Clean storage of tools, small parts or various consumables
- To save space and for tidy organisation, we recommend VIGOR separation sheets or soft foam inserts
- Similar to Series XL
- Dimensions (HxWxD)
1st - 7th drawer: 75x753x398 mm
8th drawer: 154x753x398 mm

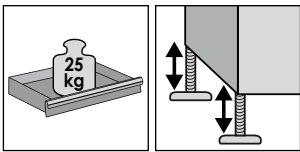

XL

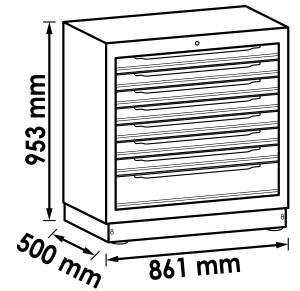

V6000-033, EAN 4047728070195

Lower cabinet for waste

- Setting up a stationary workstation
- Waste separation directly at the workstation
- Waste bin securely and neatly positioned in the wall unit module
- Lower cabinet with flap for rapid waste disposal
- Delivery including two waste bins
- Capacity of the waste bin: 35 l
- Similar to Series L



+



L

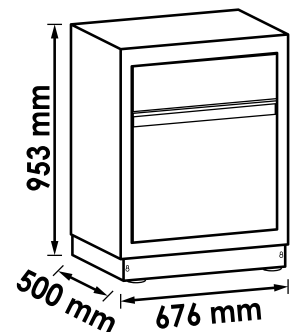

V6000-033XL, EAN 4047728070331

Lower cabinet for waste

- Setting up a stationary workstation
- Waste separation directly at the workstation
- Waste bin securely and neatly positioned in the wall unit module
- Lower cabinet with flap for rapid waste disposal
- Delivery including three waste bins
- Capacity of the waste bin: 1x25 l · 2x35 l
- Similar to Series L



+



XL

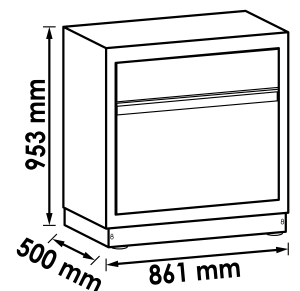

Storage system



V6000-035, EAN 4047728074582

Multipurpose lower cabinet

- Setting up a stationary workstation
- Waste bin (35 l) with access flap for quick waste disposal
- Paper reel holder
- Drawer (loading capacity 25 kg) for stowing tools, small parts and various consumables
- Drawer dimensions:
 - Left: W 288xD 397xH 707 mm
 - Right: W 260xD 397xH 340 mm

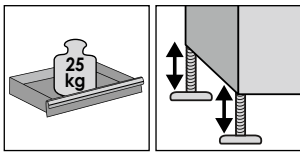
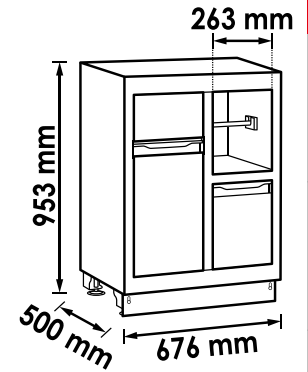

V6000-035XL, EAN 4047728074599

Multipurpose lower cabinet

- Setting up a stationary workstation
- Waste bin (35 l) with access flap for quick waste disposal
- Paper reel holder
- Drawer (loading capacity 25 kg) for stowing tools, small parts and various consumables
- Drawer dimensions:
 - Left: W 268xD 397xH 707 mm
 - Right: W 471xD 397xH 340 mm

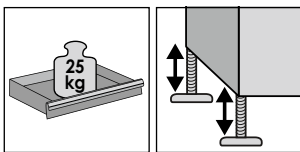
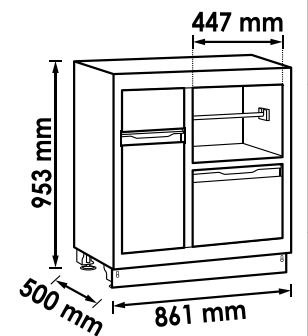

V6000-02, EAN 4047728048255

Lower cabinet with double-hinged door

- Setting up a stationary workstation
- Storage of tool boxes, work clothes, containers or motor vehicle parts
- Hinged-door with magnetic lock
- Height-adjustable storage compartment
- Inside dimensions (LxWxH): 561x466.4x561 mm
- Can be extended with additional V6000-018 storage shelves
- Similar to Series L

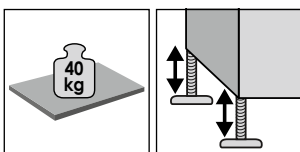
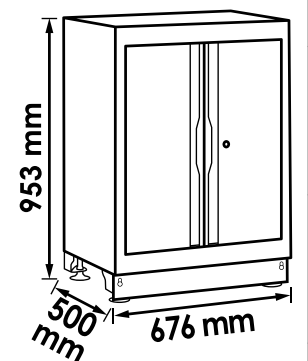

V6000-02XL, EAN 4047728070355

Lower cabinet with double-hinged door

- Setting up a stationary workstation
- Storage of tool boxes, work clothes, containers or motor vehicle parts
- Hinged-door with magnetic lock
- Height-adjustable storage compartment
- Inside dimensions (LxWxH): 561x466.4x561 mm
- Can be extended with additional V6000-018XL storage shelves
- Similar to Series XL

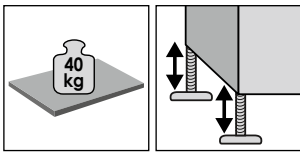
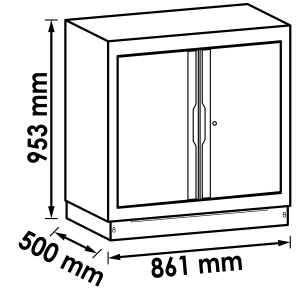

V6000-02XD, EAN 4047728081191

Double hinged-doors lower cabinet · extra deep

- Setting up a stationary workstation
- Storage of tool boxes, work clothes, containers or motor vehicle parts
- Hinged-door with magnetic lock
- Height-adjustable storage compartment
- Inside dimensions (LxWxH): 561 x 466.4 x 561 mm
- Can be retrofitted into existing systems
- Height-adjustable storage compartment
- Similar to Series XD
- Inside dimensions: 787 x 649 x 690 mm (WxDxH)



NEW

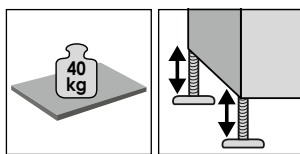
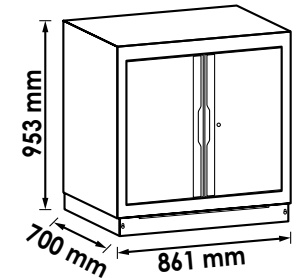

V6000-011, EAN 4047728054904

Corner base cabinet

- Corner extension for additional lower cabinets
- For corner extension of the storage system line
- Including storage shelf

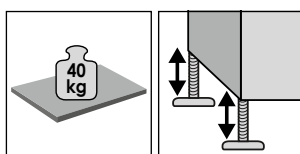
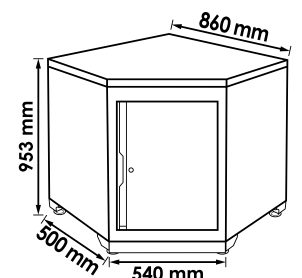

Storage system



V6000-037, EAN 4047728**075015**

Bridge-type lower cabinet

- Easy bridging of worktops – combines optimally with 500 mm deep worktops
- Creates much more workplace seating options and more storage space in your workshop
- A high drawer and a large storage compartment for stowing the tools
- Loading capacity of drawer: 25 kg
- 4 feet adjustable in height (up to 50 mm)

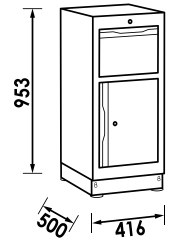
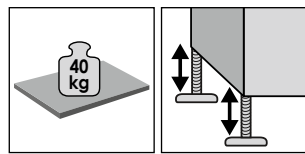

V6000-03, EAN 4047728**048262**

Cabinet with single-hinged door · high

- Storage of tool boxes, work clothes, containers or motor vehicle parts
- Cabinet door with magnetic lock
- Height-adjustable storage compartment
- Inside dimensions (LxWxH): 484x478x1503.3 / 220.5 mm
- Cabinet door can be fitted on the right and left
- Can be extended with V6000-017 storage shelves

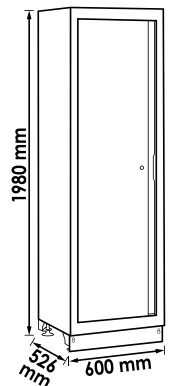
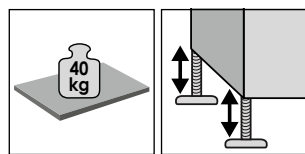

V6000-03XL, EAN 4047728**070362**

Cabinet with double-hinged door · high

- Storage of tool boxes, work clothes, containers or motor vehicle parts
- Cabinet door with magnetic lock
- Height-adjustable storage compartment
- Inside dimensions (LxWxH): 1119x510x1812 / 220.5 mm
- Cabinet door can be fitted on the right and left
- Can be extended with V6000-017XL storage shelves

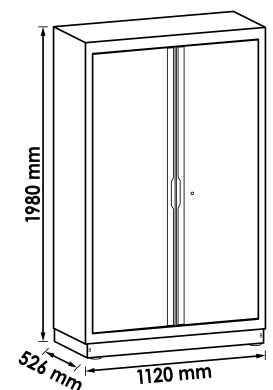
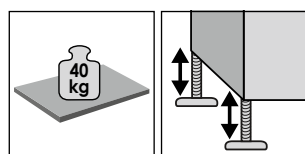

V6000-04, EAN 4047728048279

Wall cabinet

- Storage of tools, containers or motor vehicle parts

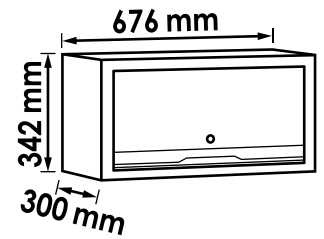

V6000-04XL, EAN 4047728070379

Wall cabinet

- Storage of tools, containers or motor vehicle parts

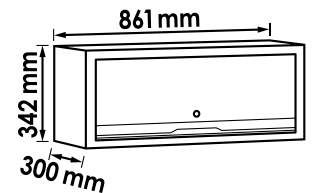

V6000-046, EAN 4047728073615

Double hinged-door wall cabinet

- Combines optimally with 700 mm deep worktops
- Including 1 storage shelf adjustable in height
- Loading capacity of storage shelf: 15 kg
- Loading capacity of shelf base: 20 kg
- Hinged-door can be rotated to left or right hand stop
- Doors with magnetic lock

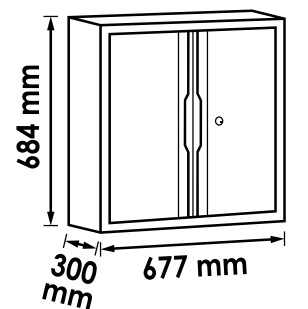

V6000-046XL, EAN 4047728073622

Double hinged-door wall cabinet

- Combines optimally with 700 mm deep worktops
- Including 1 storage shelf adjustable in height
- Loading capacity of storage shelf: 15 kg
- Loading capacity of shelf base: 20 kg
- Hinged-door can be rotated to left or right hand stop
- Doors with magnetic lock

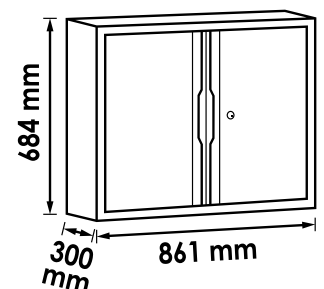

V6000-042, EAN 4047728073363

Lower cabinet extension frame

- Extension of lower cabinet to a 700 mm working depth
- Enables installation of perforated tool panel and wall cabinet supports
- Extension frames are screwed to the back of a lower cabinet
- Slim design - 676 mm

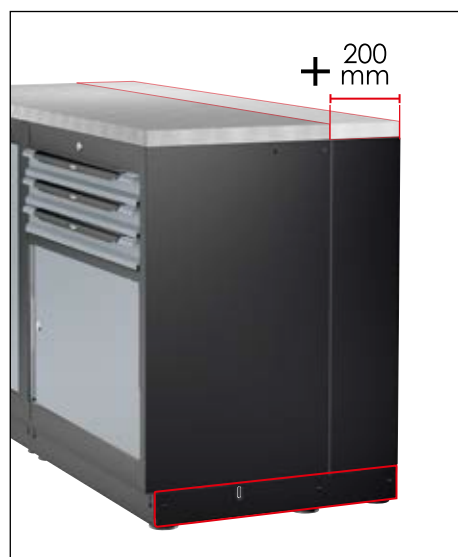
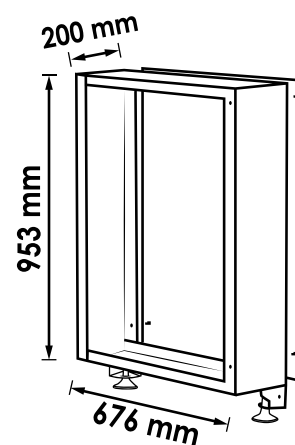
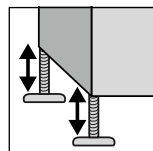

V6000-042XL, EAN 4047728073431

Lower cabinet extension frame

- Extension of lower cabinet to a 700 mm working depth
- Enables installation of perforated tool panel and wall cabinet supports
- Extension frames are screwed to the back of a lower cabinet
- Wide design - 861 mm

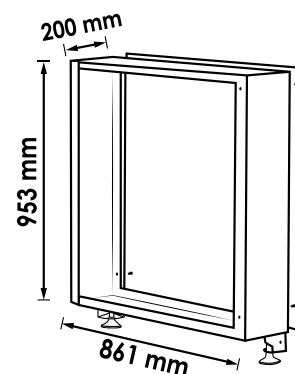
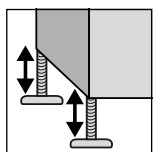

V6000-036, EAN 4047728073356

Supporting lower cabinet

- Adjustable height
- Base panels including in delivery
- Doors with magnetic lock
- 1 storage shelf included in delivery
- Slim design · 500 mm

Perforated wall construction with supporting feet also possible

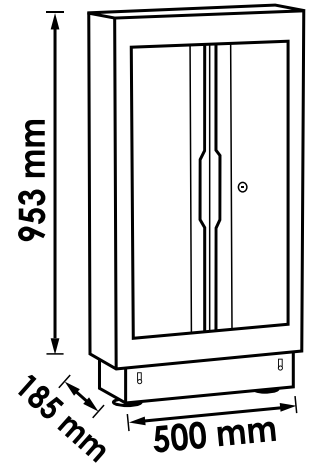

V6000-036XL, EAN 4047728073424

Supporting lower cabinet

- Adjustable height
- Base panels including in delivery
- Doors with magnetic lock
- 1 storage shelf included in delivery
- Deep design · 700 mm

Perforated wall construction with supporting feet also possible

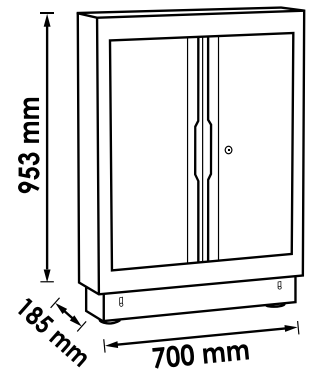

Screw jacks

- Adjustable height
- Privacy panel included in delivery

Perforated wall construction with supporting feet also possible



VIGOR No.	Designation	LxWxH mm	EAN 4047728+
V6000-044	Screw jacks	104x500x953	073325
V6000-044XL	Screw jacks	104x700x953	073370

Accessories for storage system



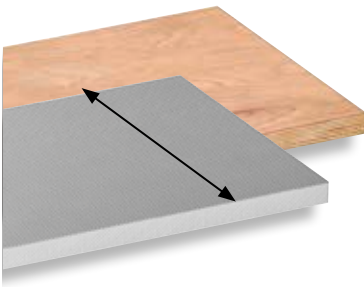

500mm



Wooden worktop

• Fixation on storage system lower cabinets



VIGOR No.	Designation	LxWxH mm	EAN 4047728+
V6000-0676	Wooden worktop · small	676 x 500 x 40	073028
V6000-0861	Wooden worktop · small	861 x 500 x 40	073042
V6000-01541	Wooden worktop combined · medium	1541 x 500 x 40	073141
V6000-01357	Wooden worktop · medium	1357 x 500 x 40	073066
V6000-01725	Wooden worktop · medium	1725 x 500 x 40	073080
V6000-02036	Wooden worktop · large	2036 x 500 x 40	073103
V6000-02215	Wooden worktop combined · large	2215 x 500 x 40	073165
V6000-02404	Wooden worktop combined · large	2404 x 500 x 40	073189
V6000-02588	Wooden worktop · large	2588 x 500 x 40	073127

Wooden worktop

VIGOR No.	Designation	LxWxH mm	EAN 4047728+
V6000-0860	Wooden worktop · pentagonal	883 x 500 x 40	073202

Stainless steel worktop

• Fixation on storage system lower cabinets



VIGOR No.	Designation	LxWxH mm	EAN 4047728+
V6000-0676-X	Stainless steel worktop · small	676 x 500 x 40	073035
V6000-0861-X	Stainless steel worktop · small	861 x 500 x 40	073059
V6000-01541-X	Stainless steel worktop combined · medium	1541 x 500 x 40	073158
V6000-01357-X	Stainless steel worktop · medium	1357 x 500 x 40	073073
V6000-01725-X	Stainless steel worktop · medium	1725 x 500 x 40	073097
V6000-02215-X	Stainless steel worktop combined · large	2215 x 500 x 40	073172
V6000-02404-X	Stainless steel worktop combined · large	2404 x 500 x 40	073196
V6000-02036-X	Stainless steel worktop · large	2036 x 500 x 40	073110
V6000-02588-X	Stainless steel worktop · large	2588 x 500 x 40	073134

Stainless steel worktop

VIGOR No.	Designation	LxWxH mm	EAN 4047728+
V6000-0860-X	Stainless steel worktop · pentagonal	883 x 500 x 40	073219

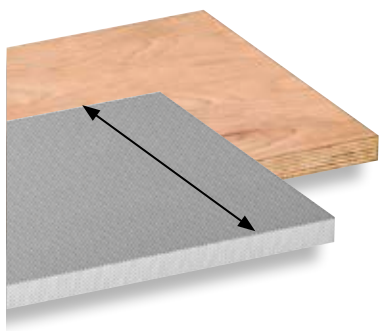

700mm



Wooden worktop

• Fixation on Storage System lower cabinets

VIGOR No.	Designation	LxWxH mm	EAN 4047728+
V6000-0676-D	Deep wooden worktop · small	676 x 700 x 40	075794
V6000-0861-D	Deep wooden worktop · small	861 x 700 x 40	075787
V6000-01357-D	Deep wooden worktop · medium	1357 x 700 x 40	073486
V6000-01725-D	Deep wooden worktop · medium	1725 x 700 x 40	073493
V6000-02036-D	Deep wooden worktop · large	2036 x 700 x 40	073509
V6000-02588-D	Deep wooden worktop · large	2588 x 700 x 40	073516



Wooden worktop

VIGOR No.	Designation	LxWxH mm	EAN 4047728+
V6000-01083-D	Deep wooden worktop · pentagonal	1083 x 700 x 40	075039

Stainless steel worktop

• Fixation on Storage System lower cabinets

VIGOR No.	Designation	LxWxH mm	EAN 4047728+
V6000-0676-XD	Deep stainless steel worktop · small	676 x 700 x 40	075640
V6000-0861-XD	Deep stainless steel worktop · small	881 x 700 x 40	075657
V6000-01357-XD	Deep stainless steel worktop · medium	1357 x 700 x 40	073448
V6000-01725-XD	Deep stainless steel worktop · medium	1725 x 700 x 40	073455
V6000-02036-XD	Deep stainless steel worktop · large	2036 x 700 x 40	073462
V6000-02588-XD	Deep stainless steel worktop · large	2588 x 700 x 40	073479



Stainless steel worktop

VIGOR No.	Designation	LxWxH mm	EAN 4047728+
V6000-01083-XD	Deep stainless steel worktop · pentagonal	1083 x 700 x 40	075022



Set of perforated tool panel plates

- Compatible with VIGOR tool hook sets

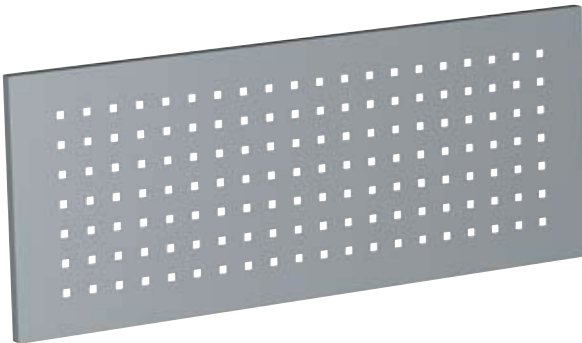

VIGOR No.	Designation		EAN 4047728+
V6000-05	Set of perforated tool panel plates · 676 x 342 mm	2	048286
V6000-015	Set of perforated tool panel plates · 861 x 342 mm	2	055260
V6000-015S	Perforated panel · 861 x 301 mm	-	072991
V6000-015SXL	Perforated panel · 861 x 985 mm	-	072984
V6000-048	Corner perforated tool panel plate	-	076135
V6000-05S	Perforated panel · 676 x 301 mm	-	073011
V6000-05SXL	Perforated panel · 676 x 985 mm	-	073004

Perforated tool panel plates with power supply

- Toggle switch for deactivating the power supply
- Only suitable for the lowest level
- Magnetic cover protects against soiling
- Integrated 3-way protective earth socket strip 230 V, 50/60 Hz
- 4 USB ports (4x 2.1 A)



VIGOR No.	Designation	EAN 4047728+
V6000-05SP	Perforated tool panel plate with power supply 676 mm	073981
V6000-015SP	Perforated tool panel plates with power supply 861 mm	073998

Storage shelf



VIGOR No.	Designation		LxWxH mm	EAN 4047728+
V6000-017	Storage shelf set for single-hinged door cabinet V6000-03	2	524x476x13	055420
V6000-017XL	Storage shelf set for double-hinged door cabinet for V6000-03XL	2	1045x476x13	070669

Storage shelf

- Storage shelf for V6000-02 · V6000-02XL



VIGOR No.	Designation	LxWxH mm	EAN 4047728+
V6000-018	Storage shelf for double hinged door lower cabinet V6000-02	601x464x13	059275
V6000-018XL	Storage shelf for double hinged door lower cabinet	785x464x13	070652

V6000-043, EAN 4047728**073813**

Base panel for lower cabinet with extension frame

- To neatly close off the side walls of all lower cabinets with extension frame
- Prevents dust and dirt from getting in
- Delivery including screws
- Base panel · 650 mm



V6000-09, EAN 4047728**048422**

Base panel for high cabinets

- To neatly close off the side walls of all high cabinets
- Prevents dust and dirt from getting in
- Delivery including screws

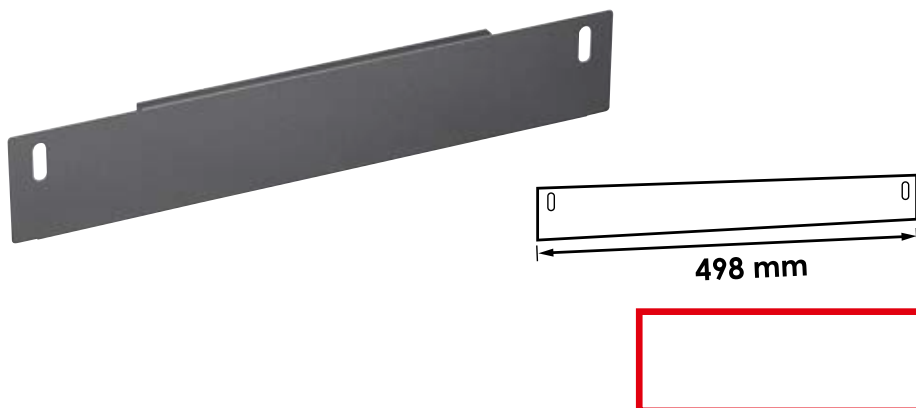

V6000-010, EAN 4047728**048439**

Base panel for lower cabinets

- To neatly close off the side walls of all lower cabinets
- Prevents dust and dirt from getting in
- Delivery including screws

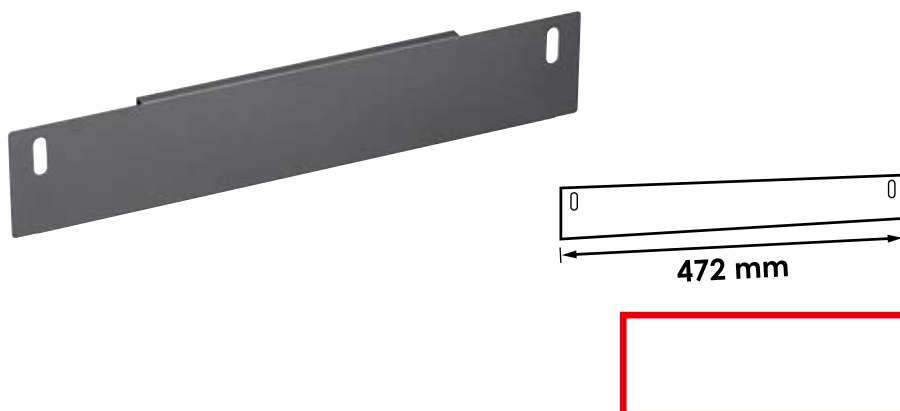

V6000-040/4, EAN 4047728**070645**

Set of connection plates

- Rear connection of two lower cabinets
- Contents: 4 connection plates including screws and nuts



V6000-041/4, EAN 4047728070676

Storage shelf support set

- For securing storage shelves



V6000-020, EAN 4047728069588

Spare lock for VIGOR storage system

- Including 2 keys
- For all VIGOR hinged-door cabinets:
V6000-030 · V6000-030XL · V6000-02 · V6000-02XL · V6000-03 · V6000-03XL · V6000-011 · V6000-046 · V6000-046XL



V6000-050, EAN 4047728073417

Storage shelf

- Simple hanging on 9 x 9 mm perforated tool panel grid
- Maximum load: 6 kg

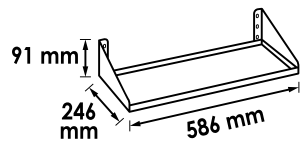
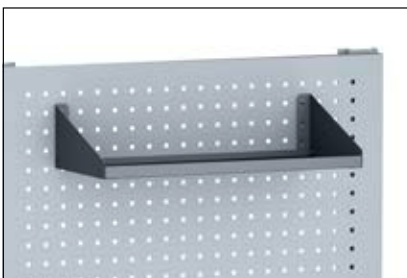

V6000-051, EAN 4047728073349

Can holder

- For storing cans
- Simple hanging on 9 x 9 mm perforated tool panel grid

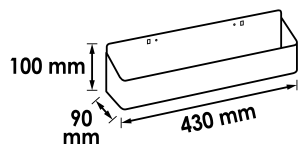
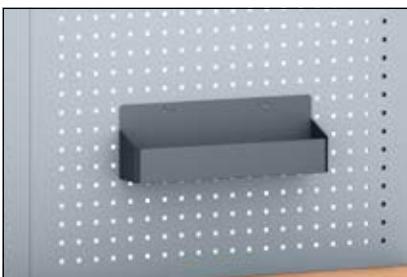

V6000-052, EAN 4047728073653

Hanging rail

- Only together with V6000-053
- For hanging a total of 6 visual storage boxes
- Simple hanging on 9x9 mm perforated tool panel grid

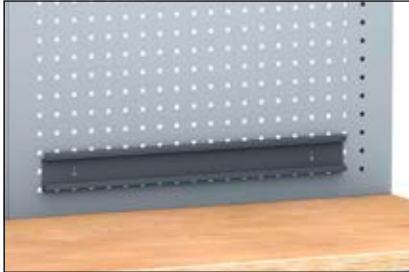

V6000-053, EAN 4047728074223

Visual storage box set

- For storing small parts
- Combines optimally with V6000-052
- 3 visual storage boxes included in delivery
- Maximum load: 3 kg



V6000-054, EAN 4047728074001

Monitor holder

- Cable routing on holder
- The retaining plate and the installation material are included in delivery
- Total outreach:
 - short swivel arm: 175 mm
 - long swivel arm: 265 mm
 - short and long combined: 350 mm
- Simple hanging on 9x9 mm perforated tool panel grid
- Maximum load: 5 kg
- 180° swivelling

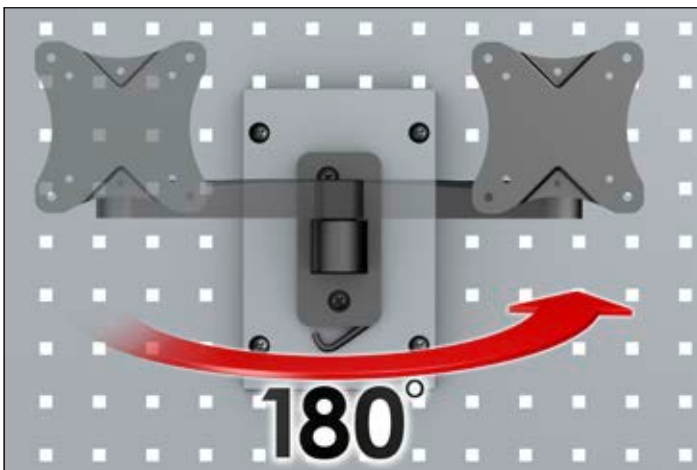
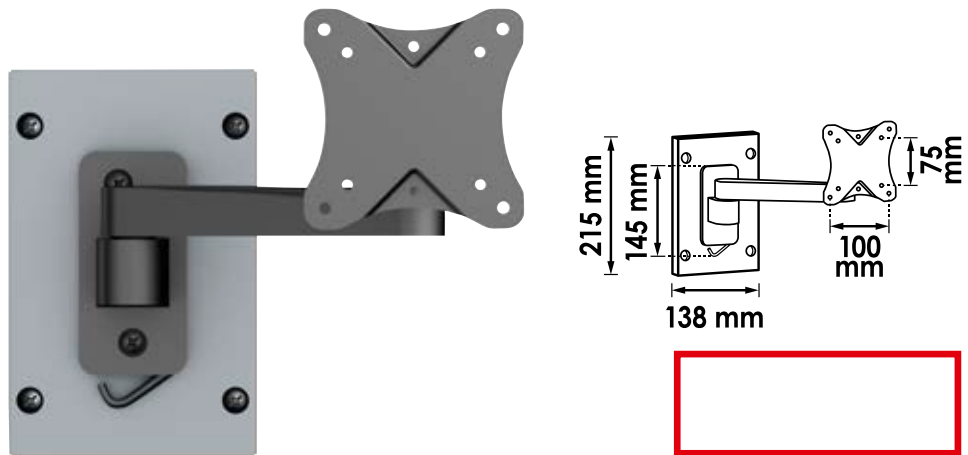

V6000-055, EAN 4047728077118

Torque wrench bracket

- For common torque wrenches
- With edge protection
- Opening width 19.5 mm



V6000-055XL, EAN 4047728077125

Torque wrench bracket · big

- For common torque wrenches
- With edge protection
- Opening width 26 mm



V6000-047LR, EAN 4047728076128

Perforated tool panel bracket set · left and right

- For mounting perforated tool panel plates and wall cabinets
- Suitable for all VIGOR perforated tool panel plates
- Cabinet wall assembly from the front thanks to additionally inserted screw sleeves
- Full-surface suspension of perforated tool panel plates possible
- Additional bore holes for wall mounting provided
- Fastening at the rear to the outer positions of the lower cabinets



V6000-047M, EAN 4047728076111

Perforated tool panel bracket · middle

- For mounting perforated tool panel plates and wall cabinets
- Suitable for all VIGOR perforated tool panel plates
- Cabinet wall assembly from the front thanks to additionally inserted screw sleeves
- Full-surface suspension of perforated tool panel plates possible
- Additional bore holes for wall mounting provided
- Fastening at the rear to the inner positions of the lower cabinets

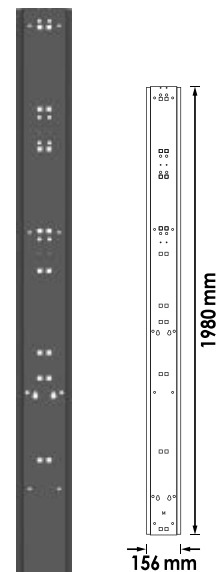
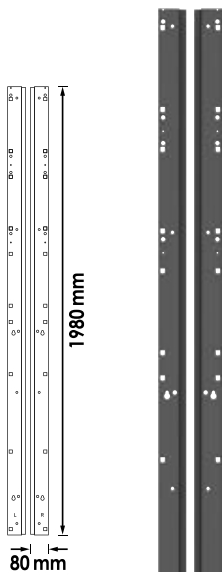

V7283, EAN 4047728072847

LED light strip · Extension

- Optimal illumination for workshops, cellars, living areas or garden sheds
- Magnetic rear side for fastening to substrates containing iron
- Adhesive strips for non-magnetic substrates included in delivery
- Robust aluminium housing
- LED light strip length: 527 mm
- Total length (including cable): 2527 mm
- Power: 1000 lm
- Maximum of 3 LED light strips can be combined with one power supply unit

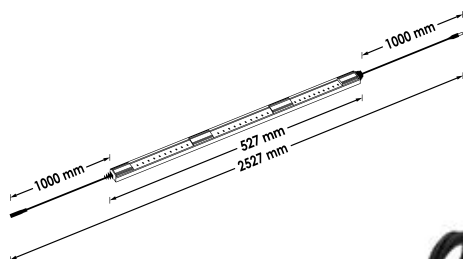

V7283/2, EAN 4047728072830

LED light strip · Basic set

- Optimal illumination for workshops, cellars, living areas or garden sheds
- Magnetic rear side for fastening to substrates containing iron
- Adhesive strips for non-magnetic substrates included in delivery
- Robust aluminium housing
- LED light strip length: 527 mm
- Total length (including cable): 2527 mm
- Power: 1000 lm
- Maximum of 3 LED light strips can be combined with one power supply unit
- Including ON/OFF switch
- Includes power supply unit 230 V, 1.5 A output

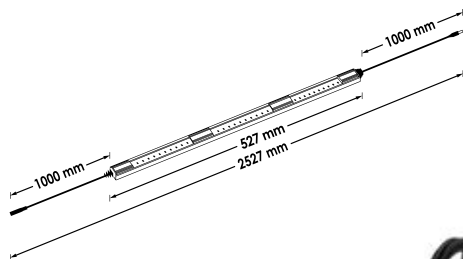

电

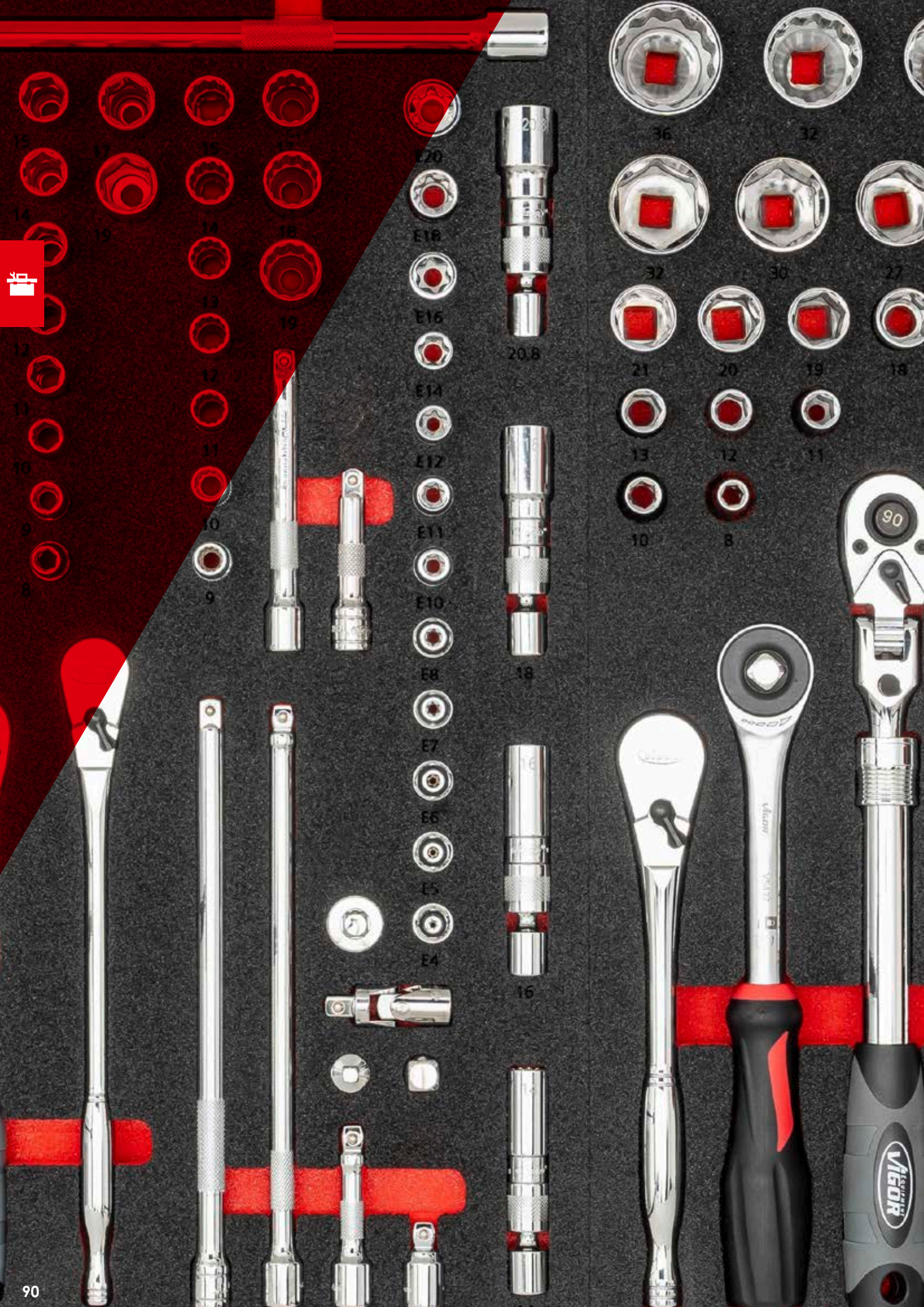

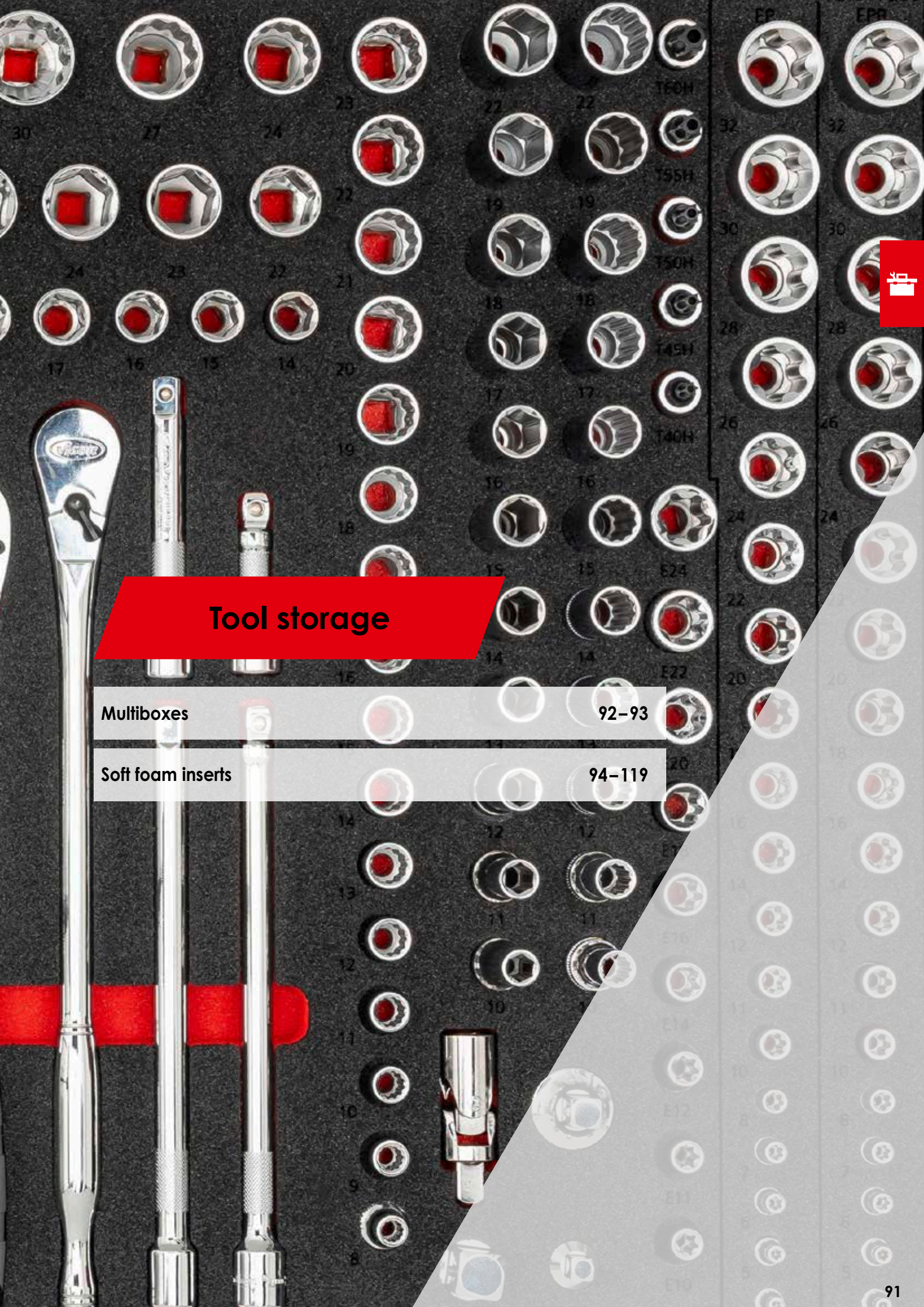

Tool storage

Multiboxes 92-93

Soft foam inserts 94-119

V4700-L, EAN 4047728**046794**

Multibox-L · empty

- Lightweight plastic box
- Maximum loading capacity: 90 kg

M

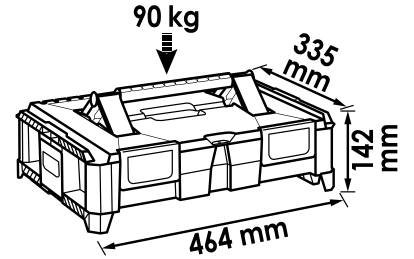

V4700-XL, EAN 4047728**049269**

Multibox-XL · empty

- Lightweight plastic box
- Maximum loading capacity: 90 kg

M

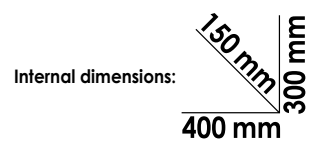
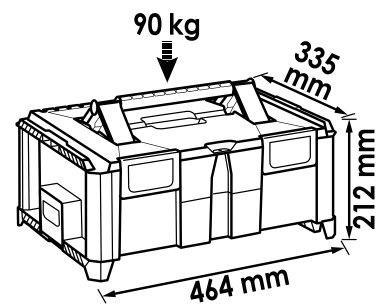

Multiboxes



V4700-XXL, EAN 4047728**049276**

Multibox-XXL · empty

- Lightweight plastic box
- Maximum loading capacity: 90 kg

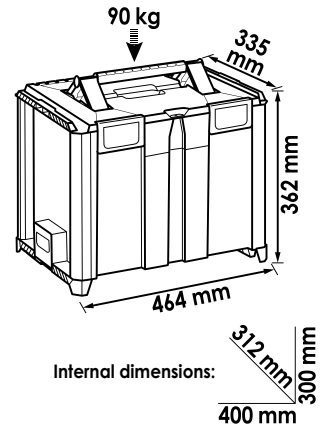

V4700-A, EAN 4047728**075077**

Multibox expansion set

- For combining VIGOR multiboxes with third-party products
- Simple "click" system for quick connections
- Multibox expansion set



V4700-R, EAN 4047728**049283**

Mechanic's creeper for multibox

- Mechanic's creeper for V4700-L · V4700-XL and V4700-XXL
- Maximum loading capacity: 200 kg

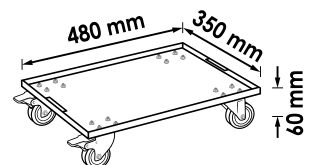
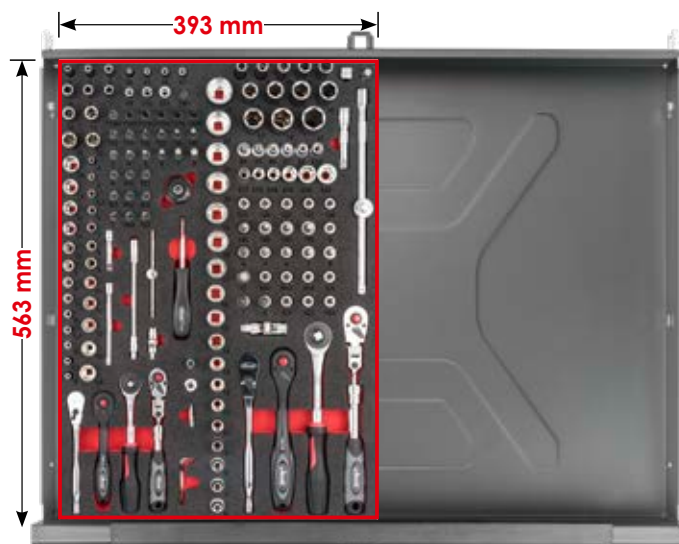
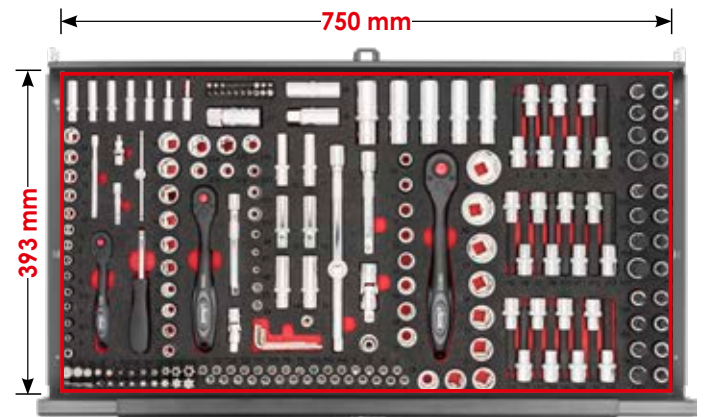
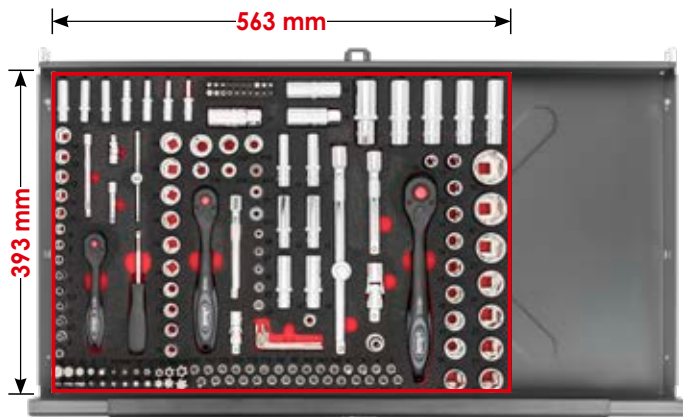
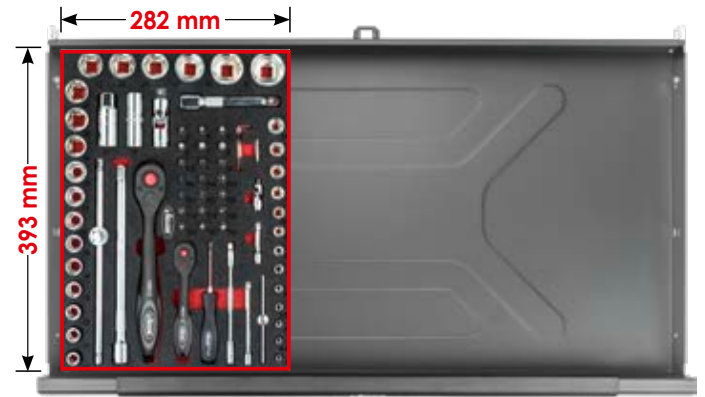

Illustration of the drawer pictograms



Soft foam inserts



V4971, EAN 4047728**049719**
Socket tool set



XX	■		Design	Size
13 x	6.3	1/4		4 · 4.5 · 5 · 5.5 · 6 · 7 · 8 · 9 · 10 · 11 · 12 · 13 · 14 mm
7 x	6.3	1/4		4 · 5 · 6 · 7 · 8 · 9 · 10 mm
7 x	6.3	1/4		E4 · E5 · E6 · E7 · E8 · E10 · E11
6 x	6.3	1/4		3 · 4 · 5 · 6 · 7 · 8 mm
3 x	6.3	1/4		PH1 · PH2 · PH3
3 x	6.3	1/4		0.8x4-1x5.5-1.2x7 mm
3 x	6.3	1/4		PZ1 · PZ2 · PZ3
6 x	6.3	1/4		T10 · T15 · T20 · T25 · T30 · T40

XX	■		Design	Size
7 x	6.3	1/4		T9H · T10H · T15H · T20H · T25H · T27H · T30H
1 x	-	6.3	1/4	150 mm
1 x	6.3	1/4		40 mm
1 x	10	3/8		27 mm
1 x	6.3	1/4		110 mm
1 x	6.3	1/4		145 mm
1 x	6.3	1/4		50 mm
1 x	6.3	1/4		100 mm
2 x	-			1.3 · 2 mm
1 x	-	6.3	1/4	150 mm

V4971-L, EAN 4047728**049702**
Soft foam insert · empty



V4973, EAN 4047728**049733**
Socket tool set



XX	■		Design	Size
18 x	10	3/8		6 · 7 · 8 · 9 · 10 · 11 · 12 · 13 · 14 · 15 · 16 · 17 · 18 · 19 · 20 · 21 · 22 · 24 mm
10 x	10	3/8		8 · 9 · 10 · 11 · 12 · 13 · 14 · 15 · 17 · 19 mm
7 x	10	3/8		3 · 4 · 5 · 6 · 7 · 8 · 10 mm
3 x	10	3/8		0.8x5.5-1x7-1.2x8 mm
3 x	10	3/8		PH1 · PH2 · PH3

XX	■		Design	Size
3 x	10	3/8		PZ1 · PZ2 · PZ3
9 x	10	3/8		T15 · T20 · T25 · T27 · T30 · T40 · T45 · T50 · T55
2 x	10	3/8		16 · 21 mm
1 x	10	3/8		28 mm
1 x	12.5	1/2		40 mm
1 x	10	3/8		50 mm
1 x	10	3/8		75 mm
1 x	10	3/8		250 mm
1 x	-	10	3/8	198 mm

V4973-L, EAN 4047728**049726**
Soft foam insert · empty



V4975, EAN 4047728**049757**
Socket tool set



XX	■		Design	Size
18 x	12.5	1/2		10 · 11 · 12 · 13 · 14 · 15 · 16 · 17 · 18 · 19 · 20 · 21 · 22 · 23 · 24 · 27 · 30 · 32 mm
2 x	12.5	1/2		16 · 21 mm

XX	■		Design	Size
1 x	-	12.5	1/2	250 mm
1 x	12.5	1/2		75 mm
1 x	12.5	1/2		125 mm
1 x	12.5	1/2		250 mm
1 x	-	12.5	1/2	250 mm

V4975-L, EAN 4047728**049740**
Soft foam insert · empty



V7323, EAN 4047728073240

Socket set



XX	■	Design	Size
3 x	6.3 1/4		11 · 12 · 13 mm
5 x	10 3/8		E10 · E12 · E14 · E16 · E18
8 x	12.5 1/2		10 · 12 · 14 · 16 · 17 · 18 · 19 · 22 mm

XX	■	Design	Size
5 x	12.5 1/2		E14 · E16 · E18 · E20 · E22
5 x	12.5 1/2		15 · 17 · 19 · 21 · 22 mm

V7323-L, EAN 4047728073233

Soft foam insert · empty



V5602, EAN 4047728056021

Impact socket set



XX	■	Design	Size
13 x	12.5 1/2		10 · 11 · 12 · 13 · 14 · 15 · 16 · 17 · 18 · 19 · 21 · 22 · 24 mm

XX	■	Design	Size
13 x	12.5 1/2		10 · 11 · 12 · 13 · 14 · 15 · 16 · 17 · 18 · 19 · 21 · 22 · 24 mm

V5602-L, EAN 4047728056038

Soft foam insert · empty



V5099, EAN 4047728050999

Screwdriver socket set

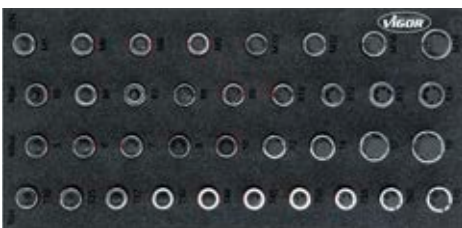

XX	■	Design	Size
10 x	12.5 1/2		T20 · T25 · T27 · T30 · T40 · T45 · T50 · T55 · T60 · T70
9 x	12.5 1/2		M5 · M6 · M7 · M8 · M9 · M10 · M12 · M13 · M14

XX	■	Design	Size
9 x	12.5 1/2		5 · 6 · 7 · 8 · 10 · 12 · 14 · 17 · 19 mm
8 x	12.5 1/2		M5 · M6 · M8 · M9 · M10 · M12 · M14 · M16

V5099-L, EAN 4047728051002

Soft foam insert · empty



V5095, EAN 4047728050951

T screwdriver socket set



XX	■	Design	Size
6 x	12.5 1/2		T40 · T45 · T50 · T55 · T60 · T70
10 x	12.5 1/2		T20 · T25 · T27 · T30 · T40 · T45 · T50 · T55 · T60 · T70

XX	■	Design	Size
10 x	12.5 1/2		T20 · T25 · T27 · T30 · T40 · T45 · T50 · T55 · T60 · T70

V5095-L, EAN 4047728050968

Soft foam insert · empty



Soft foam inserts



V5091, EAN 4047728050913
Screwdriver socket set for screws with internal serration (XZN)

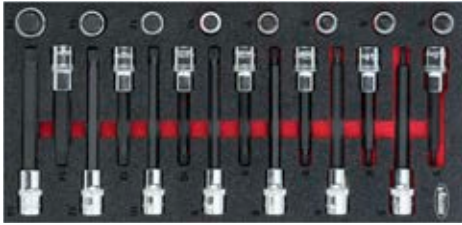

XX			Design	Size
7 x		1/2		M5 · M6 · M8 · M9 · M10 · M12 · M14
7 x		1/2		M5 · M6 · M8 · M9 · M10 · M12 · M14

XX			Design	Size
8 x		1/2		M5 · M6 · M8 · M9 · M10 · M12 · M14 · M16

V5091-L, EAN 4047728050920
Soft foam insert · empty



V5097, EAN 4047728050975
Screwdriver socket set for inside hexagon screws

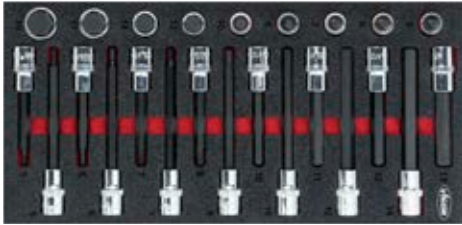

XX			Design	Size
7 x		1/2		5 · 6 · 7 · 8 · 10 · 12 · 14 mm
8 x		1/2		5 · 6 · 7 · 8 · 10 · 11 · 12 · 13 mm

XX			Design	Size
9 x		1/2		5 · 6 · 7 · 8 · 10 · 12 · 14 · 17 · 19 mm

V5097-L, EAN 4047728050982
Soft foam insert · empty



V6721, EAN 4047728067461
Double open-end wrench set



XX		Design	Size
12 x			6 x 7 · 8 x 9 · 10 x 11 · 12 x 13 · 14 x 15 · 16 x 17 · 18 x 19 · 20 x 22 · 21 x 23 · 24 x 27 · 25 x 28 · 30 x 32 mm

V6721-L, EAN 4047728067218
Soft foam insert · empty



V6723, EAN 4047728067485
Combination wrench set



XX		Design	Size
18 x			6 · 7 · 8 · 9 · 10 · 11 · 12 · 13 · 14 · 15 · 16 · 17 · 18 · 19 · 21 · 22 · 24 · 27 mm

V6723-L, EAN 4047728067232
Soft foam insert · empty



V6722, EAN 4047728**067478**
Double box-end wrench set



XX	Design	Size
11 x		6x7 · 8x9 · 10x11 · 12x13 · 14x15 · 16x17 · 18x19 · 20x22 · 21x23 · 24x27 · 25x28 mm



V6722-L, EAN 4047728**067225**
Soft foam insert · empty



V5075, EAN 4047728**050753**
Ratcheting combination wrench set · short



XX	Design	Size
12 x		8 · 9 · 10 · 11 · 12 · 13 · 14 · 15 · 16 · 17 · 18 · 19 mm



V5075-L, EAN 4047728**050760**
Soft foam insert · empty



V4987, EAN 4047728**049870**
Ratcheting combination wrench set

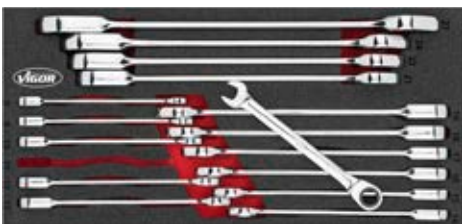

XX	Design	Size
16 x		8 · 9 · 10 · 11 · 12 · 13 · 14 · 15 · 16 · 17 · 18 · 19 · 21 · 22 · 24 · 27 mm



V4987-L, EAN 4047728**049863**
Soft foam insert · empty



V5077, EAN 4047728**050777**
Ratcheting combination wrench set with hinge



XX	Design	Size
12 x		8 · 9 · 10 · 11 · 12 · 13 · 14 · 15 · 16 · 17 · 18 · 19 mm



V5077-L, EAN 4047728**050784**
Soft foam insert · empty



Soft foam inserts



V4989, EAN 4047728**049894**
Screwdriver set



XX	Design	Size
6 x		0.6x3 · 0.8x4 · 1x5.5 · 1.2x6.5 · 1.6x8 · 1.6x10 mm
1 x		PH3
1 x		1x5.5 mm

XX	Design	Size
1 x		PH2
3 x		PH1 · PH2 · PH3

V4989-L, EAN 4047728**049887**
Soft foam insert · empty



V5068, EAN 4047728**050685**
Screwdriver set with impact cap



XX	Design	Size
3 x		PH1 · PH2 · PH3

XX	Design	Size
7 x		0.6x3.5-1x4.5-1x5.5 · 1.2x6.5 · 1.6x8 · 1.6x10 · 2x12 mm

V5068-L, EAN 4047728**050678**
Soft foam insert · empty



V4991, EAN 4047728**049917**
T screwdriver set



XX	Design	Size
11 x		T6 · T7 · T8 · T9 · T10 · T15 · T20 · T25 · T27 · T30 · T40

V4991-L, EAN 4047728**049900**
Soft foam insert · empty



V4995, EAN 4047728**049955**
Double joint pliers set



XX	Design	Size
1 x		340 mm
1 x		335 mm

XX	Design	Size
1 x		300 mm
1 x		290 mm

V4995-L, EAN 4047728**049948**
Soft foam insert · empty



V5004, EAN 4047728050043

Grip pliers set



XX	Design	Size
1 x		16 - 27 mm
1 x		11 - 19 mm
1 x		125 mm

XX	Design	Size
1 x		250 mm
1 x		150 mm

V5004-L, EAN 4047728050005

Soft foam insert · empty



V6222, EAN 4047728062374

Hammer, chisel and drift pin set



XX	Design	Size
1 x		∅ 4 mm
1 x		18 mm
1 x		6 mm

XX	Design	Size
1 x		500 g
7 x		∅ 2 · 3 · 4 · 5 · 6 · 7 · 8 mm

V6222-L, EAN 4047728062633

Soft foam insert · empty



V5006, EAN 4047728050067

Hammer and chisel set



XX	Design	Size
1 x		6 mm
1 x		18 mm
1 x		∅ 4 mm

XX	Design	Size
6 x		∅ 2 · 3 · 4 · 5 · 6 · 8 mm
1 x		∅ 40 mm
1 x		800 g

V5006-L, EAN 4047728050050

Soft foam insert · empty



V5070, EAN 4047728050708

Hook and scraper set



XX	Design	Size
1 x		130 mm
1 x		130 mm
1 x		130 mm
1 x		130 mm
1 x		260 mm

XX	Design	Size
1 x		260 mm
1 x		260 mm
1 x		260 mm
1 x		260 mm

V5070-L, EAN 4047728050692

Soft foam insert · empty



Soft foam inserts



V5017, EAN 4047728050173
Scraper set



XX	Design	Size
1 x		22 mm
1 x		32 mm
1 x		32 mm
1 x		20 mm

XX	Design	Size
1 x		20 mm
1 x		40 mm
1 x		10 x

V5017-L, EAN 4047728050166
Soft foam insert · empty



V5072, EAN 4047728050722
File set



XX	Design	Size
1 x		310 mm
1 x		310 mm
1 x		310 mm

XX	Design	Size
1 x		310 mm
1 x		310 mm

V5072-L, EAN 4047728050715
Soft foam insert · empty



V5011, EAN 4047728050111
VDE socket set



XX	Design	Size
9 x		8 · 10 · 12 · 13 · 14 · 17 · 19 · 22 · 24 mm
3 x		5 · 6 · 8 mm

XX	Design	Size
1 x		125 mm
1 x		255 mm

V5011-L, EAN 4047728050104
Soft foam insert · empty



V5013, EAN 4047728050135
VDE screwdriver set



XX	Design	Size
3 x		PH0 · PH1 · PH2
4 x		0.5x3 · 0.8x4 · 1x5.5 · 1.2x6.5 mm

XX	Design	Size
1 x		0.5x3 mm

V5013-L, EAN 4047728050128
Soft foam insert · empty



V5015, EAN 4047728**050159**

VDE pliers set

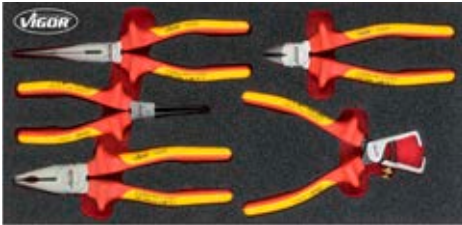

XX	Design	Size
1 x		180 mm
1 x		160 mm
1 x		160 mm

XX	Design	Size
1 x		200 mm
1 x		160 mm

V5015-L, EAN 4047728**050142**

Soft foam insert · empty



V4999N, EAN 4047728**078726**

Pliers set

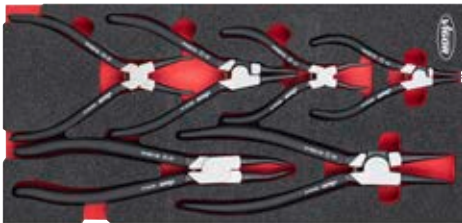

XX	Design	Size
3 x		140 · 180 · 230 mm

XX	Design	Size
3 x		140 · 180 · 230 mm

V4999N-L, EAN 4047728**077989**

Soft foam insert · empty



V5603, EAN 4047728**078917**

Impact screwdriver socket set



XX	Design	Size
8 x		5 · 6 · 8 · 10 · 12 · 14 · 17 · 19 mm
8 x		M5 · M6 · M8 · M10 · M12 · M14 · M16 · M18

XX	Design	Size
8 x		T30 · T40 · T45 · T50 · T55 · T60 · T70 · T80

V5603-L, EAN 4047728**078580**

Soft foam insert · empty



V5633N, EAN 4047728**078740**

Pliers set



XX	Design	Size
1 x		250 mm
1 x		200 mm

XX	Design	Size
1 x		180 mm
1 x		160 mm

V5633N-L, EAN 4047728**078009**

Soft foam insert · empty



Soft foam inserts



V7324, EAN 4047728080262
Impact socket set

NEW

32

2 K

S



XX	■	Design	Size
9 x	12.9 1/2		10 · 11 · 12 · 13 · 14 · 15 · 16 · 17 · 19 mm
13 x	12.9 1/2		10 · 11 · 12 · 13 · 14 · 15 · 16 · 17 · 18 · 19 · 21 · 22 · 24 mm
5 x	12.9 1/2		15 · 17 · 19 · 21 · 22 mm

XX	■	Design	Size
1 x	12.9 1/2		17 mm
1 x	12.9 1/2		18.5 · 19.5 mm
1 x	12.9 1/2		21 mm
1 x	12.9 1/2		22.2 mm

V7324-L, EAN 4047728080248
Soft foam insert · empty



V7520, EAN 4047728075824
12-point socket set

42

2 K

S

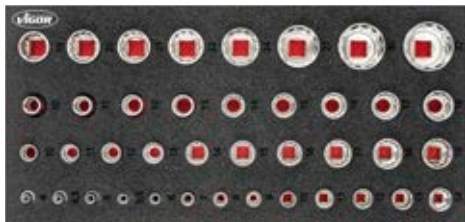

XX	■	Design	Size
17 x	12.9 1/2		10 · 11 · 12 · 13 · 14 · 15 · 16 · 17 · 18 · 19 · 20 · 21 · 22 · 24 · 27 · 30 · 32 mm
10 x	10 3/8		10 · 11 · 12 · 13 · 14 · 15 · 16 · 17 · 18 · 19 mm

XX	■	Design	Size
13 x	6.3 1/4		4 · 4.5 · 5 · 5.5 · 6 · 7 · 8 · 9 · 10 · 11 · 12 · 13 · 14 mm

V7520-L, EAN 4047728075800
Soft foam insert · empty



V5103, EAN 4047728051033
Socket set

71

2 K

M



XX	■	Design	Size
13 x	6.3 1/4		4 · 4.5 · 5 · 5.5 · 6 · 7 · 8 · 9 · 10 · 11 · 12 · 13 · 14 mm
6 x	6.3 1/4		3 · 4 · 5 · 6 · 7 · 8 mm
3 x	6.3 1/4		PH1 · PH2 · PH3
3 x	6.3 1/4		PZ1 · PZ2 · PZ3
3 x	6.3 1/4		0.8x4-1x5.5-1.2x7 mm
6 x	6.3 1/4		T10 · T15 · T20 · T25 · T30 · T40
1 x	-	6.3 1/4	150 mm
1 x	6.3 1/4	6.3 1/4	110 mm
1 x	6.3 1/4	6.3 1/4	40 mm
1 x	6.3 1/4	6.3 1/4	145 mm

XX	■	Design	Size
1 x	6.3 1/4	6.3 1/4	50 mm
1 x	6.3 1/4	6.3 1/4	100 mm
18 x	12.9 1/2		10 · 11 · 12 · 13 · 14 · 15 · 16 · 17 · 18 · 19 · 20 · 21 · 22 · 23 · 24 · 27 · 30 · 32 mm
2 x	12.9 1/2		16 · 21 mm
1 x	-	12.9 1/2	250 mm
1 x	12.9 1/2	12.9 1/2	75 mm
1 x	12.9 1/2	12.9 1/2	125 mm
1 x	12.9 1/2	12.9 1/2	250 mm
2 x	-		1.3 · 2 mm
1 x	-	6.3 1/4	150 mm
1 x	-	12.9 1/2	250 mm
1 x	6.3 1/4	6.3 1/4	25 mm

V5103-L, EAN 4047728051040
Soft foam insert · empty



V5081, EAN 4047728050814

Screwdriver set



XX	Design	Size
9 x		T10 · T15 · T20 · T25 · T27 · T30 · T40 · T45 · T50
1 x		0.5x3 mm
9 x		1.5 · 2 · 2.5 · 3 · 4 · 5 · 6 · 8 · 10 mm
6 x		0.6x3 · 0.8x4 · 1x5.5 · 1.2x6.5 · 1.6x8 · 1.6x10 mm

XX	Design	Size
4 x		PH0 · PH1 · PH2 · PH3
1 x		1x5.5 mm
1 x		PH2

V5081-L, EAN 4047728050821

Soft foam insert · empty



V5085, EAN 4047728050852

Hammer and chisel set



XX	Design	Size
1 x		20 mm
1 x		32 mm
1 x		18 mm
1 x		Ø 4 mm
1 x		6 mm

XX	Design	Size
6 x		Ø 2 · 3 · 4 · 5 · 6 · 8 mm
1 x		1500 g
1 x		800 g
1 x		Ø 32 mm

V5085-L, EAN 4047728050869

Soft foam insert · empty



V5087, EAN 4047728050876

VDE tool set



XX	Design	Size
1 x		0.5x3 mm
1 x		160 mm
1 x		160 mm
1 x		180 mm

XX	Design	Size
1 x		200 mm
1 x		160 mm
4 x		0.5x3 · 0.8x4 · 1x5.5 · 1.2x6.5 mm
3 x		PH0 · PH1 · PH2

V5087-L, EAN 4047728050883

Soft foam insert · empty



Soft foam inserts



V4188, EAN 4047728041881
Socket tool set



XX	■	●	Design	Size
5 x	6.3 1/4	+		R5 · R6 · R7 · R8 · R9
3 x	6.3 1/4	+		T5 · T6 · T7
3 x	6.3 1/4	○		M5 · M6 · M8
9 x	6.3 1/4	+		T7H · T10H · T15H · T20H · T25H · T27H · T30H · T40H · T45H
6 x	8 5/16	+		T40 · T45 · T50 · T55 · T60 · T70
5 x	8 5/16	○		7 · 8 · 10 · 12 · 14 mm
2 x	8 5/16	+		PH3 · PH4
2 x	8 5/16	+		PZ3 · PZ4
3 x	8 5/16	○		1.6x8-1.6x10-2x12 mm
6 x	8 5/16	+		T40H · T45H · T50H · T55H · T60H · T70H
2 x	-	○		1.3 · 2 mm
1 x	10 3/8	8 5/16		28 mm
1 x	12 1/2	8 5/16		37 mm
1 x	-	6.3 1/4		150 mm
1 x	6.3 1/4	6.3 1/4		110 mm
1 x	-	12 1/2		43.7 mm
4 x	6.3 1/4	○		3 · 4 · 5 · 6 mm
4 x	6.3 1/4	○		0.8 x 4 · 1x5.5-1.2x6.5-1.2x7 mm

XX	■	●	Design	Size
3 x	6.3 1/4	+		PH0 · PH1 · PH2
3 x	6.3 1/4	+		PZ0 · PZ1 · PZ2
7 x	6.3 1/4	+		T9 · T10 · T15 · T20 · T25 · T27 · T30
7 x	6.3 1/4	+		T9H · T10H · T15H · T20H · T25H · T27H · T30H
6 x	10 3/8	○		E10 · E11 · E12 · E14 · E16 · E18
6 x	10 3/8	○		10 · 11 · 12 · 13 · 14 · 15 mm
10 x	10 3/8	○		10 · 11 · 12 · 13 · 14 · 15 · 16 · 17 · 18 · 19 mm
17 x	12 1/2	○		10 · 11 · 12 · 13 · 14 · 15 · 16 · 17 · 18 · 19 · 20 · 21 · 22 · 24 · 27 · 30 · 32 mm
5 x	12 1/2	○		16 · 17 · 18 · 19 · 22 mm
2 x	12 1/2	○		E20 · E24
13 x	6.3 1/4	○		4 · 4.5 · 5 · 5.5 · 6 · 7 · 8 · 9 · 10 · 11 · 12 · 13 · 14 mm
7 x	6.3 1/4	○		4 · 5 · 6 · 7 · 8 · 9 · 10 mm
5 x	6.3 1/4	+		E4 · E5 · E6 · E7 · E8
1 x	-	6.3 1/4		150 mm
1 x	-	10 3/8		198 mm
1 x	-	12 1/2		250 mm
1 x	6.3 1/4	6.3 1/4		40 mm
1 x	10 3/8	10 3/8		50 mm
1 x	12 1/2	12 1/2		75 mm
1 x	6.3 1/4	6.3 1/4		50 mm
1 x	6.3 1/4	6.3 1/4		100 mm
1 x	10 3/8	10 3/8		125 mm
1 x	12 1/2	12 1/2		125 mm
1 x	12 1/2	12 1/2		250 mm
1 x	10 3/8	○		18 mm
2 x	12 1/2	○		16 · 21 mm

V4130, EAN 4047728041300
Soft foam insert · empty



V5115, EAN 4047728051293

Socket set



XX	■		Design	Size
12 x	6.3 1/4	●		4 · 5 · 5.5 · 6 · 7 · 8 · 9 · 10 · 11 · 12 · 13 · 14 mm
1 x	6.3 1/4	6.3 1/4		40 mm
1 x	6.3 1/4	6.3 1/4		50 mm
1 x	6.3 1/4	6.3 1/4		100 mm
1 x	-	6.3 1/4		150 mm
1 x	-	6.3 1/4		150 mm
17 x	12.5 1/2	●		10 · 11 · 12 · 13 · 14 · 15 · 17 · 16 · 18 · 19 · 20 · 21 · 22 · 24 · 27 · 30 · 32 mm
2 x	12.5 1/2	●		16 · 21 mm
1 x	12.5 1/2	12.5 1/2		75 mm
1 x	12.5 1/2	12.5 1/2		125 mm

XX	■		Design	Size
1 x	12.5 1/2	12.5 1/2		250 mm
1 x	-	12.5 1/2		250 mm
1 x	-	12.5 1/2		43.7 mm
1 x	6.3 1/4	6.3 1/4		25 mm
1 x	6.3 1/4	10 3/8		26 mm
1 x	10 3/8	6.3 1/4		27 mm
1 x	10 3/8	12.5 1/2		36 mm
1 x	12.5 1/2	10 3/8		36 mm
1 x	12.5 1/2	20 3/4		46 mm
1 x	20 3/4	12.5 1/2		50 mm
5 x	6.3 1/4			32 x

V5115-L, EAN 4047728051811

Soft foam insert · empty



V2837, EAN 4047728028370

Socket set

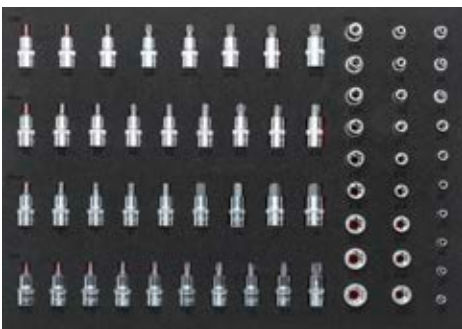

XX	■		Design	Size
7 x	6.3 1/4	●		E4 · E5 · E6 · E7 · E8 · E10 · E11
12 x	10 3/8	●		E4 · E5 · E6 · E7 · E8 · E10 · E11 · E12 · E14 · E16 · E18 · E20
9 x	12.5 1/2	●		E10 · E11 · E12 · E14 · E16 · E18 · E20 · E22 · E24
8 x	12.5 1/2	○		M5 · M6 · M8 · M9 · M10 · M12 · M14 · M16

XX	■		Design	Size
9 x	12.5 1/2	○		5 · 6 · 7 · 8 · 10 · 12 · 14 · 17 · 19 mm
9 x	12.5 1/2	●		M5 · M6 · M7 · M8 · M9 · M10 · M12 · M13 · M14
10 x	12.5 1/2	●		T20 · T25 · T27 · T30 · T40 · T45 · T50 · T55 · T60 · T70

V2838, EAN 4047728028387

Soft foam insert · empty



Soft foam inserts



V5109, EAN 4047728051095
Socket set



XX	■	Design	Size
16 x	20 3/4		19 · 21 · 22 · 23 · 24 · 26 · 27 · 28 · 30 · 32 · 34 · 36 · 38 · 41 · 46 · 50 mm
1 x	-	20 3/4	500 mm

XX	■	Design	Size
1 x	20 3/4	20 3/4	200 mm
1 x	20 3/4	20 3/4	100 mm
1 x	20 3/4	20 3/4	400 mm
1 x	-	20 3/4	450 mm



V5109-L, EAN 4047728051101
Soft foam insert · empty



V4753, EAN 4047728047531
Screwdriver socket set



XX	■	Design	Size
9 x	12 1/2		M5 · M6 · M7 · M8 · M9 · M10 · M12 · M13 · M14
9 x	12 1/2		M5 · M6 · M7 · M8 · M9 · M10 · M12 · M13 · M14
10 x	12 1/2		T20 · T25 · T27 · T30 · T40 · T45 · T50 · T55 · T60 · T70
10 x	12 1/2		T20 · T25 · T27 · T30 · T40 · T45 · T50 · T55 · T60 · T70

XX	■	Design	Size
7 x	12 1/2		M5 · M6 · M8 · M9 · M10 · M12 · M14
8 x	12 1/2		M5 · M6 · M8 · M9 · M10 · M14 · M16 · M12
8 x	12 1/2		5 · 6 · 7 · 8 · 10 · 11 · 12 · 13 mm
9 x	12 1/2		5 · 6 · 7 · 8 · 10 · 12 · 14 · 17 · 19 mm

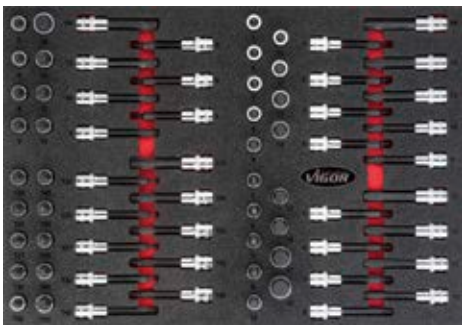

V4752, EAN 4047728047524
Soft foam insert · empty



V4727, EAN 4047728047272
Screwdriver socket set



XX	■	Design	Size
10 x	12 1/2		T20 · T25 · T27 · T30 · T40 · T45 · T50 · T55 · T60 · T70
10 x	12 1/2		T20 · T25 · T27 · T30 · T40 · T45 · T50 · T55 · T60 · T70
6 x	12 1/2		T40 · T45 · T50 · T55 · T60 · T70
6 x	12 1/2		T40 · T45 · T50 · T55 · T60 · T70

XX	■	Design	Size
9 x	12 1/2		5 · 6 · 7 · 8 · 10 · 12 · 14 · 17 · 19 mm
8 x	12 1/2		5 · 6 · 7 · 8 · 10 · 11 · 12 · 13 mm
7 x	12 1/2		5 · 6 · 7 · 8 · 10 · 12 · 14 mm
6 x	12 1/2		5 · 6 · 7 · 8 · 10 · 12 mm



V4726, EAN 4047728047265
Soft foam insert · empty



V4729, EAN 4047728**047296**

Screwdriver socket set

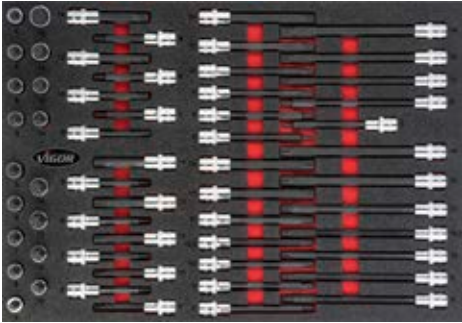

XX		Design	Size
8 x			M5 · M6 · M8 · M9 · M10 · M12 · M14 · M16
7 x			M5 · M6 · M8 · M9 · M10 · M12 · M14
7 x			M5 · M6 · M8 · M9 · M10 · M12 · M14
4 x			M8 · M10 · M12 · M14

XX		Design	Size
9 x			M5 · M6 · M7 · M8 · M9 · M10 · M12 · M13 · M14
9 x			M5 · M6 · M7 · M8 · M9 · M10 · M12 · M13 · M14
7 x			M8 · M9 · M10 · M10.3 · M12 · M13 · M14
7 x			M8 · M9 · M10 · M10.3 · M12 · M13 · M14

V4728, EAN 4047728**047289**

Soft foam insert · empty

V6726, EAN 4047728**067515**

Double open-end, double box-end and combination wrench set

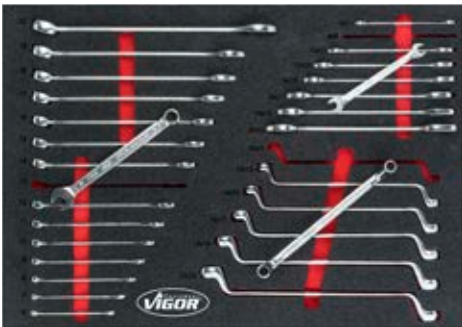

XX		Design	Size
8 x			6x7 · 8x9 · 10x11 · 12x13 · 14x15 · 16x17 · 18x19 · 20x22 mm
15 x			6 · 7 · 8 · 9 · 10 · 11 · 12 · 13 · 14 · 15 · 16 · 17 · 18 · 19 · 22 mm

XX		Design	Size
6 x			10x11 · 12x13 · 14x15 · 16x17 · 18x19 · 20x22 mm

V6726-L, EAN 4047728**067263**

Soft foam insert · empty

V6643, EAN 4047728**067430**

Double box-end wrench, double open-end wrench, combination wrench set

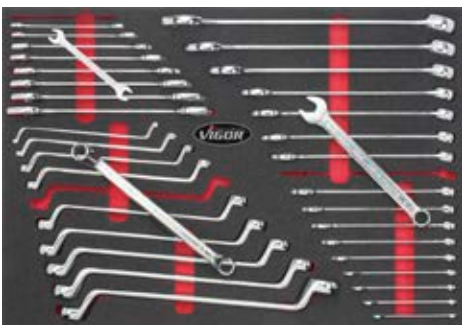

XX		Design	Size
9 x			6x7 · 8x9 · 10x11 · 12x13 · 14x15 · 16x17 · 18x19 · 20x22 · 21x23 mm
17 x			6 · 7 · 8 · 9 · 10 · 11 · 12 · 13 · 14 · 15 · 16 · 17 · 18 · 19 · 22 · 24 · 27 mm

XX		Design	Size
10 x			6x7 · 8x9 · 10x11 · 12x13 · 14x15 · 16x17 · 18x19 · 20x22 · 21x23 · 24x27 mm

V6643-L, EAN 4047728**066433**

Soft foam insert · empty

Soft foam inserts



V6724, EAN 4047728**067492**

Double open-end wrench, combination wrench, ratcheting combination wrench set



XX	Design	Size
12 x		8 · 9 · 10 · 11 · 12 · 13 · 14 · 15 · 16 · 17 · 18 · 19 mm
12 x		6 x 7 · 8 x 9 · 10 x 11 · 12 x 13 · 14 x 15 · 16 x 17 · 18 x 19 · 20 x 22 · 21 x 23 · 24 x 27 · 25 x 28 · 30 x 32 mm

XX	Design	Size
21 x		6 · 7 · 8 · 9 · 10 · 11 · 12 · 13 · 14 · 15 · 16 · 17 · 18 · 19 · 20 · 21 · 22 · 24 · 27 · 30 · 32 mm



V6724-L, EAN 4047728**067249**

Soft foam insert · empty



V4230, EAN 4047728**042307**

Screwdriver set



XX	Design	Size
6 x		6 · 7 · 8 · 10 · 12 · 13 mm
6 x		0.6 x 3 · 0.8 x 4 · 1 x 5.5 · 1.2 x 6.5 · 1.6 x 8 · 1.6 x 10 mm
4 x		PH0 · PH1 · PH2 · PH3
1 x		1 x 5.5 mm
1 x		PH2

XX	Design	Size
7 x		T10 · T15 · T20 · T25 · T27 · T30 · T40
1 x		0.5 x 3 mm
2 x		PH1 · PH2
4 x		0.6 x 3.5 · 1 x 4.5 · 1 x 5.5 · 1.2 x 6.5 mm



V4231, EAN 4047728**042314**

Soft foam insert · empty



V5175, EAN 4047728**051750**

T-handle screwdriver and offset screwdriver set



XX	Design	Size
9 x		1.5 · 2 · 2.5 · 3 · 4 · 5 · 6 · 8 · 10 mm
9 x		T10 · T15 · T20 · T25 · T27 · T30 · T40 · T45 · T50

XX	Design	Size
8 x		2 · 2.5 · 3 · 4 · 5 · 6 · 8 · 10 mm
8 x		T9 · T10 · T15 · T20 · T25 · T27 · T30 · T40



V5175-L, EAN 4047728**051767**

Soft foam insert · empty



V6821, EAN 4047728068222

Socket set

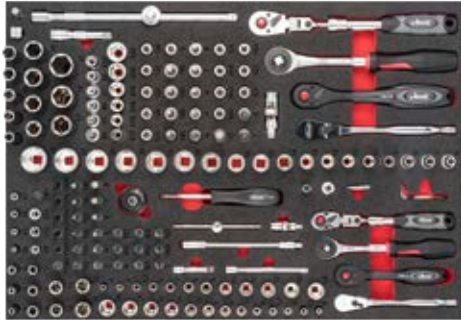

XX	■		Design	Size	XX	■		Design	Size		
12 x	10	3/8		E4 · E5 · E6 · E7 · E8 · E10 · E11 · E12 · E14 · E16 · E18 · E20	13 x	6.3	1/4		4 · 4.5 · 5 · 5.5 · 6 · 7 · 8 · 9 · 10 · 11 · 12 · 13 · 14 mm		
18 x	10	3/8		6 · 7 · 8 · 9 · 10 · 11 · 12 · 13 · 14 · 15 · 16 · 17 · 18 · 19 · 20 · 21 · 22 · 24 mm	6 x	6.3	1/4		T10 · T15 · T20 · T25 · T30 · T40		
10 x	10	3/8		8 · 9 · 10 · 11 · 12 · 13 · 14 · 15 · 17 · 19 mm	7 x	6.3	1/4		T9H · T10H · T15H · T20H · T25H · T27H · T30H		
2 x	10	3/8		16 · 21 mm	6 x	6.3	1/4		3 · 4 · 5 · 6 · 7 · 8 mm		
9 x	10	3/8		T15 · T20 · T25 · T27 · T30 · T40 · T45 · T50 · T55	3 x	6.3	1/4		PH1 · PH2 · PH3		
7 x	10	3/8		3 · 4 · 5 · 6 · 7 · 8 · 10 mm	3 x	6.3	1/4		PZ1 · PZ2 · PZ3		
3 x	10	3/8		PH1 · PH2 · PH3	3 x	6.3	1/4		PZ1 · PZ2 · PZ3		
3 x	10	3/8		PZ1 · PZ2 · PZ3	3 x	6.3	1/4		0.8x4-1x5.5 · 1.2x6.5 mm		
3 x	10	3/8		0.8x5.5-1x7 · 1.2x8 mm	1 x	6.3	1/4		26 mm		
1 x	10	3/8		250 mm	1 x	-	10	3/8		198 mm	
1 x	10	3/8		50 mm	1 x	-	10	3/8		198 mm	
1 x	10	3/8		75 mm	1 x	-	10	3/8		237 mm	
1 x	10	3/8		36 mm	1 x	-	6.3	1/4		150 mm	
1 x	10	3/8		27 mm	1 x	6.3	1/4		110 mm		
1 x	12.5	1/2		40 mm	1 x	6.3	1/4		40 mm		
7 x	6.3	1/4		E4 · E5 · E6 · E7 · E8 · E10 · E11	1 x	6.3	1/4		145 mm		
11 x	6.3	1/4		4 · 5 · 6 · 7 · 8 · 9 · 10 · 11 · 12 · 13 · 14 mm	1 x	6.3	1/4		50 mm		
10 x	6.3	1/4		4 · 5 · 6 · 7 · 8 · 9 · 10 · 11 · 12 · 13 mm	1 x	6.3	1/4		100 mm		
					1 x	-	6.3	1/4		150 mm	
					1 x	-	6.3	1/4		150 mm	
					1 x	-	6.3	1/4		176 mm	
					1 x	-	6.3	1/4		29 mm	
					1 x	8	5/16	10	3/8		30 mm
					1 x	6.3	1/4		25 mm		

V6821-L, EAN 4047728068055

Soft foam insert · empty



V6822, EAN 4047728068284

Socket set



XX	■		Design	Size	XX	■		Design	Size	
6 x	12.5	1/2		E14 · E16 · E18 · E20 · E22 · E24	1 x	12.5	1/2		36 mm	
18 x	12.5	1/2		10 · 11 · 12 · 13 · 14 · 15 · 16 · 17 · 18 · 19 · 20 · 21 · 22 · 23 · 24 · 27 · 30 · 32 mm	1 x	12.5	1/2		75 mm	
11 x	12.5	1/2		10 · 11 · 12 · 13 · 14 · 15 · 16 · 17 · 18 · 19 · 22 mm	1 x	12.5	1/2		125 mm	
2 x	12.5	1/2		16 · 21 mm	1 x	12.5	1/2		250 mm	
17 x	12.5	1/2		10 · 11 · 12 · 13 · 14 · 15 · 16 · 17 · 18 · 19 · 20 · 21 · 22 · 24 · 27 · 30 · 32 mm	1 x	12.5	1/2		46 mm	
					1 x	20	3/4		50 mm	
					1 x	-	12.5	1/2		288 mm
					1 x	-	12.5	1/2		250 mm
					1 x	-	12.5	1/2		250 mm
					1 x	-	12.5	1/2		250 mm

V6822-L, EAN 4047728068062

Soft foam insert · empty



Soft foam inserts



V6809, EAN 4047728068307
Screwdriver socket set

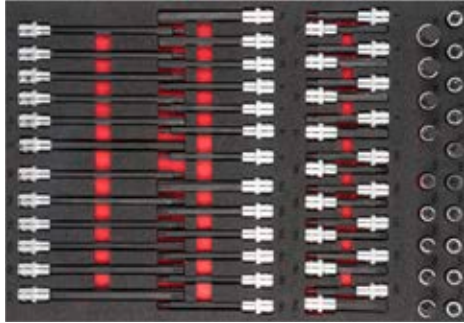

XX	■	Design	Size
10 x	$\frac{1}{2}$		T20 · T25 · T27 · T30 · T40 · T45 · T50 · T55 · T60 · T70
10 x	$\frac{1}{2}$		T20 · T25 · T27 · T30 · T40 · T45 · T50 · T55 · T60 · T70
6 x	$\frac{1}{2}$		T40 · T45 · T50 · T55 · T60 · T70
6 x	$\frac{1}{2}$		T40 · T45 · T50 · T55 · T60 · T70

XX	■	Design	Size
9 x	$\frac{1}{2}$		5 · 6 · 7 · 8 · 10 · 12 · 14 · 17 · 19 mm
8 x	$\frac{1}{2}$		5 · 6 · 7 · 8 · 10 · 11 · 12 · 13 mm
7 x	$\frac{1}{2}$		5 · 6 · 7 · 8 · 10 · 12 · 14 mm
6 x	$\frac{1}{2}$		5 · 6 · 7 · 8 · 10 · 12 mm

V6809-L, EAN 4047728068093
Soft foam insert · empty



V6810, EAN 4047728068413
Screwdriver socket set

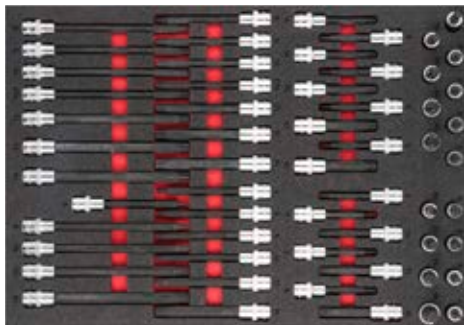

XX	■	Design	Size
9 x	$\frac{1}{2}$		M5 · M6 · M7 · M8 · M9 · M10 · M12 · M13 · M14
9 x	$\frac{1}{2}$		M5 · M6 · M7 · M8 · M9 · M10 · M12 · M13 · M14
7 x	$\frac{1}{2}$		M8 · M9 · M10 · M10.3 · M12 · M13 · M14
7 x	$\frac{1}{2}$		M8 · M9 · M10 · M10.3 · M12 · M13 · M14

XX	■	Design	Size
8 x	$\frac{1}{2}$		M5 · M6 · M8 · M9 · M10 · M12 · M14 · M16
7 x	$\frac{1}{2}$		M5 · M6 · M8 · M9 · M10 · M12 · M14
7 x	$\frac{1}{2}$		M5 · M6 · M8 · M10 · M12 · M14 · M9
4 x	$\frac{1}{2}$		M8 · M10 · M12 · M14

V6810-L, EAN 4047728068109
Soft foam insert · empty



V6807, EAN 4047728068277
Ratcheting combination wrench set



XX	Design	Size
18 x		8 · 9 · 10 · 11 · 12 · 13 · 14 · 15 · 16 · 17 · 18 · 19 · 21 · 22 · 24 · 27 · 30 · 32 mm

XX	Design	Size
22 x		6 · 7 · 8 · 9 · 10 · 11 · 12 · 14 · 13 · 15 · 16 · 17 · 18 · 19 · 20 · 21 · 22 · 24 · 27 · 30 · 32 · 36 mm

V6807-L, EAN 4047728068079
Soft foam insert · empty



V6808, EAN 4047728**068291**

Double box-end and open-end wrench set

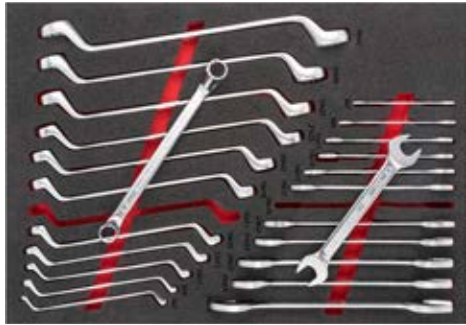

XX	Design	Size
12 x		6x7 · 8x9 · 10x11 · 12x13 · 14x15 · 16x17 · 18x19 · 20x22 · 21x23 · 24x27 · 25x28 · 30x32 mm

XX	Design	Size
12 x		6x7 · 8x9 · 10x11 · 12x13 · 14x15 · 16x17 · 18x19 · 20x22 · 21x23 · 24x27 · 25x28 · 30x32 mm

V6808-L, EAN 4047728**068086**

Soft foam insert · empty



V6813, EAN 4047728**068444**

Screwdriver set

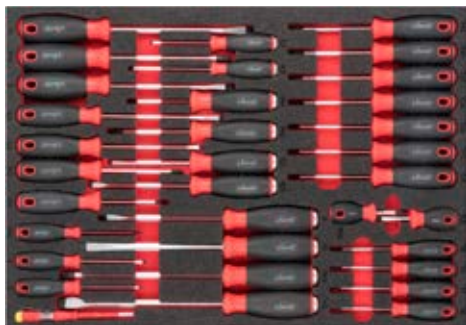

XX	Design	Size
6 x		0.6x3 · 0.8x4 · 1x5.5 · 1.2x6.5 · 1.6x8 · 1.6x10 mm
4 x		PH0 · PH1 · PH2 · PH3
1 x		1x5.5 mm
1 x		PH2

XX	Design	Size
7 x		0.6x3.5 · 1x4.5 · 1x5.5 · 1.2x6.5 · 1.6x8 · 1.6x10 · 2x12 mm
3 x		PH1 · PH2 · PH3
11 x		T6 · T7 · T8 · T9 · T10 · T15 · T20 · T25 · T27 · T30 · T40
1 x		0.5x3 mm

V6813-L, EAN 4047728**068130**

Soft foam insert · empty



V6814, EAN 4047728**068451**

Screwdriver and bit set



XX	Design	Size
4 x		1.6 · 2 · 2.4 · 3 mm
2 x		PH0 · PH00
1 x		260 mm
1 x		260 mm
1 x		260 mm
1 x		260 mm
1 x		260 mm
1 x		260 mm
1 x		130 mm
1 x		130 mm
1 x		130 mm
1 x		130 mm

XX	Design	Size
5 x		32 x
5 x		22 x
3 x		6 · 7 · 8 mm
9 x		T10 · T15 · T20 · T25 · T27 · T30 · T40 · T45 · T50
9 x		1.5 · 2 · 2.5 · 3 · 4 · 5 · 6 · 8 · 10 mm
6 x		6 · 7 · 8 · 10 · 12 · 13 mm

V6814-L, EAN 4047728**068147**

Soft foam insert · empty



Soft foam inserts



V6817, EAN 4047728068499
Hammer, chisel and drift pin set



XX	Design	Size
1 x		800 g
1 x		1500 g
1 x		∅ 32 mm
1 x		645 mm
1 x		10 x
1 x		210 mm
1 x		10 x
1 x		90 mm

XX	Design	Size
1 x		-
6 x		∅ 3 · 4 · 5 · 6 · 8 · 2 mm
1 x		6 mm
1 x		18 mm
1 x		∅ 4 mm
2 x		190 · 170 mm
2 x		∅ 4 · 40 mm
4 x		10 · 16 · 20 · 29 mm
7 x		∅ 2 · 3 · 4 · 5 · 6 · 7 · 8 mm



V6817-L, EAN 4047728068178
Soft foam insert · empty



V6818, EAN 4047728068482
Scraper and release lever set



XX	Design	Size
1 x		165 mm
1 x		5 x
1 x		490 mm
1 x		16 x

XX	Design	Size
1 x		22 mm
1 x		10 x
1 x		4 x
1 x		40 mm



V6818-L, EAN 4047728068185
Soft foam insert · empty



V6811, EAN 4047728068420
Impact socket set



XX	Design	Size
1 x		-
1 x		-
1 x		-
5 x		15 · 17 · 19 · 21 · 22 mm
1 x		17 mm
1 x		19 mm
13 x		10 · 11 · 12 · 13 · 14 · 15 · 16 · 17 · 18 · 19 · 21 · 22 · 24 mm

XX	Design	Size
13 x		10 · 11 · 12 · 13 · 14 · 15 · 16 · 17 · 18 · 19 · 21 · 22 · 24 mm
8 x		T30 · T40 · T45 · T50 · T55 · T60 · T70 · T80
8 x		M5 · M6 · M8 · M10 · M12 · M14 · M16 · M18
8 x		5 · 6 · 8 · 10 · 12 · 14 · 17 · 19 mm
1 x		17 mm
4 x		24 · 30 · 32 · 36 mm



V6811-L, EAN 4047728068116
Soft foam insert · empty



V6812, EAN 4047728**068437**
Specialty tools for wheels / tyres



XX	Design	Size
1 x		-
1 x		-
1 x		9 mm
1 x		500 mm
1 x		-

XX	Design	Size
1 x		128 mm
1 x		4 x
1 x		128 1/2 118 mm
1 x		250 mm
1 x		128 1/2 540 mm



V6812-L, EAN 4047728**068123**
Soft foam insert · empty



V5111N, EAN 4047728**078733**
Screwdriver and pliers set



XX	Design	Size
1 x		300 g
1 x		160 mm
6 x		∅ 2 · 3 · 4 · 5 · 6 · 8 mm
1 x		∅ 4 mm
1 x		0,05 – 1,00 mm

XX	Design	Size
2 x		0,6 x 3 – 1,2 x 6,5 · PH0 – PH2
1 x		250 mm
1 x		200 mm
9 x		T10 · T15 · T20 · T25 · T27 · T30 · T40 · T45 · T50
9 x		1,5 · 2 · 2,5 · 3 · 4 · 5 · 6 · 8 · 10 mm



V5111N-L, EAN 4047728**077996**
Soft foam insert · empty



V5634N, EAN 4047728**078757**
Hammer, pliers and screwdriver set



XX	Design	Size
1 x		-
1 x		250 mm
1 x		300 g
1 x		∅ 32 mm
1 x		160 mm

XX	Design	Size
1 x		200 mm
1 x		∅ 4 mm
6 x		∅ 2 · 3 · 4 · 5 · 6 · 8 mm
1 x		0,05 – 1,00 mm
2 x		0,6 x 3 – 1,2 x 6,5 · PH0 – PH2



V5634N-L, EAN 4047728**078016**
Soft foam insert · empty



Soft foam inserts



V5636N, EAN 4047728078764
Pliers and hammer set



XX	Design	Size
1 x		40 mm
1 x		340 mm
1 x		200 mm
1 x		180 mm
1 x		160 mm

XX	Design	Size
3 x		230 · 180 · 140 mm
3 x		230 · 140 · 180 mm
1 x		Ø 40 mm
1 x		800 g
1 x		22 mm
1 x		10 x
1 x		250 mm

V5636N-L, EAN 4047728078030
Soft foam insert · empty



V5637N, EAN 4047728078771
Pliers, hammer and chisel set



XX	Design	Size
1 x		0,05 – 1,00 mm
1 x		180 mm
1 x		180 mm
1 x		180 mm
1 x		180 mm
1 x		180 mm
1 x		Ø 4 mm
6 x		Ø 2 · 3 · 4 · 5 · 6 · 8 mm

XX	Design	Size
1 x		18 mm
1 x		6 mm
1 x		180 mm
1 x		160 mm
1 x		Ø 32 mm
1 x		300 g
1 x		22 mm
1 x		250 mm
1 x		-

V5637N-L, EAN 4047728078047
Soft foam insert · empty



V6815N, EAN 4047728078795
Pliers set



XX	Design	Size
1 x		115 mm
1 x		180 mm
1 x		160 mm
1 x		200 mm
1 x		250 mm
1 x		290 mm

XX	Design	Size
1 x		300 mm
1 x		340 mm
1 x		340 mm
1 x		335 mm
1 x		345 mm
1 x		345 mm

V6815N-L, EAN 4047728078061
Soft foam insert · empty



V4586, EAN 4047728045865
Socket tool set for Series XL



XX	■	○	Design	Size	XX	■	○	Design	Size		
5 x	6.3 1/4	+		R5 · R6 · R7 · R8 · R9	4 x	6.3 1/4	○		3 · 4 · 5 · 6 mm		
3 x	6.3 1/4	+		T5 · T6 · T7	3 x	6.3 1/4	+		PH0 · PH1 · PH2		
3 x	6.3 1/4	○		M5 · M6 · M8	3 x	6.3 1/4	+		PZ0 · PZ1 · PZ2		
9 x	6.3 1/4	+		T7H · T10H · T15H · T20H · T25H · T27H · T30H · T40H · T45H	4 x	6.3 1/4	○		0.8x4 · 1x5.5 · 1.2x6.5 · 1.2x7 mm		
6 x	8 9/16	+		T40 · T45 · T50 · T55 · T60 · T70	7 x	6.3 1/4	+		T9H · T10H · T15H · T20H · T25H · T27H · T30H		
5 x	8 9/16	○		7 · 8 · 10 · 12 · 14 mm	10 x	10 3/8	○		10 · 11 · 12 · 13 · 14 · 15 · 16 · 17 · 18 · 19 mm		
2 x	8 9/16	+		PH3 · PH4	6 x	10 3/8	○		10 · 11 · 12 · 13 · 14 · 15 mm		
2 x	8 9/16	+		PZ3 · PZ4	6 x	10 3/8	○		E10 · E11 · E12 · E14 · E16 · E18		
3 x	8 9/16	○		1.6x8 · 1.6x10 · 2 x 12 mm	6 x	10 3/8	○		10 · 11 · 12 · 13 · 14 · 15 · 16 · 17 · 18 · 19 · 20 · 21 · 22 · 24 · 27 · 30 · 32 mm		
6 x	8 9/16	+		T40H · T45H · T50H · T55H · T60H · T70H	17 x	12 1/2	1/2	○		16 · 17 · 18 · 19 · 22 mm	
2 x	-	○		1.3 · 2 mm	5 x	12 1/2	1/2	○		E20 · E24	
1 x	10 3/8	8 9/16		28 mm	2 x	12 1/2	1/2	○		4 · 4.5 · 5 · 5.5 · 6 · 7 · 8 · 9 · 10 · 11 · 12 · 13 · 14 mm	
1 x	6.3 1/4	6.3 1/4		25 mm	13 x	6.3 1/4	○		4 · 5 · 6 · 7 · 8 · 9 · 10 mm		
1 x	12 1/2	8 9/16		37 mm	7 x	6.3 1/4	○		E4 · E5 · E6 · E7 · E8		
1 x	6.3 1/4	6.3 1/4		25 mm	1 x	-	6.3 1/4		150 mm		
1 x	6.3 1/4	6.3 1/4		110 mm	1 x	-	10 3/8		198 mm		
1 x	-	6.3 1/4		150 mm	1 x	-	12 1/2	1/2		250 mm	
1 x	-	12 1/2	1/2	43.7 mm	1 x	6.3 1/4	6.3 1/4		40 mm		
8 x	12 1/2	1/2	+	T20 · T25 · T27 · T30 · T40 · T45 · T50 · T55	1 x	10 3/8	10 3/8		50 mm		
8 x	12 1/2	1/2	+	T27 · T30 · T40 · T45 · T50 · T55 · T60 · T70	1 x	12 1/2	1/2	12 1/2	1/2		75 mm
8 x	12 1/2	1/2	○	M5 · M6 · M8 · M9 · M10 · M14 · M16 · M12	1 x	6.3 1/4	6.3 1/4		50 mm		
7 x	12 1/2	1/2	○	M5 · M6 · M8 · M9 · M10 · M12 · M14	1 x	6.3 1/4	6.3 1/4		100 mm		
8 x	12 1/2	1/2	○	5 · 6 · 7 · 8 · 10 · 12 · 14 · 17 mm	1 x	10 3/8	10 3/8		125 mm		
8 x	12 1/2	1/2	○	5 · 6 · 7 · 8 · 10 · 11 · 12 · 13 mm	1 x	12 1/2	1/2	12 1/2	1/2		125 mm
7 x	6.3 1/4	+		T9 · T10 · T15 · T20 · T25 · T27 · T30	1 x	12 1/2	1/2	12 1/2	1/2		250 mm
					1 x	10 3/8	○		18 mm		
					2 x	12 1/2	1/2	○		16 · 21 mm	

V4521, EAN 4047728045216

Soft foam insert · empty



V6831, EAN 4047728082280
Torque wrench insert including 40-200 Nm torque wrench



XX	■	○	Design	Size
1 x	12 1/2	1/2		540 mm



V6831-L, EAN 4047728082242

Soft foam insert · empty



Soft foam inserts



V6650, EAN 4047728067454

Combination wrench, double box-end wrench, double open-end wrench set for series XL



XX	Design	Size
12 x		6 x 7 · 8 x 9 · 10 x 11 · 12 x 13 · 14 x 15 · 16 x 17 · 18 x 19 · 20 x 22 · 21 x 23 · 24 x 27 · 25 x 28 · 30 x 32 mm
12 x		6 x 7 · 8 x 9 · 10 x 11 · 12 x 13 · 14 x 15 · 16 x 17 · 18 x 19 · 20 x 22 · 21 x 23 · 24 x 27 · 25 x 28 · 30 x 32 mm

XX	Design	Size
12 x		8 · 9 · 10 · 11 · 12 · 13 · 14 · 15 · 16 · 17 · 18 · 19 mm
22 x		6 · 7 · 8 · 9 · 10 · 11 · 12 · 13 · 14 · 15 · 16 · 17 · 18 · 19 · 20 · 21 · 22 · 24 · 27 · 30 · 32 · 36 mm



V6650-L, EAN 4047728066501

Soft foam insert · empty



V5170, EAN 4047728051712

Screwdriver set for Series XL



XX	Design	Size
4 x		1.6 · 2 · 2.4 · 3 mm
2 x		PH0 · PH00
11 x		T6 · T7 · T8 · T9 · T10 · T15 · T20 · T25 · T27 · T30 · T40
4 x		PH0 · PH1 · PH2 · PH3
3 x		PH1 · PH2 · PH3
1 x		PH2
5 x		0.6 x 3 · 0.8 x 4 · 1 x 5.5 · 1.6 x 8 · 1.6 x 10 mm

XX	Design	Size
4 x		0.6 x 3.5 · 1 x 4.5 · 1 x 5.5 · 1.2 x 6.5 mm
1 x		1 x 5.5 mm
9 x		T10 · T15 · T20 · T25 · T27 · T30 · T40 · T45 · T50
9 x		1.5 · 2 · 2.5 · 3 · 4 · 5 · 6 · 8 · 10 mm
6 x		6 · 7 · 8 · 10 · 12 · 13 mm
1 x		0.5 x 3 mm



V5170-L, EAN 4047728051729

Soft foam insert · empty



V5638N, EAN 4047728078788

Pliers, hammer and chisel set for Series XL



XX	Design	Size
1 x		1000 g
1 x		∅ 32 mm
1 x		22 mm
6 x		∅ 2 · 3 · 4 · 5 · 6 · 8 mm
1 x		∅ 4 mm
1 x		18 mm
1 x		6 mm
1 x		40 mm
1 x		10 x
1 x		150 mm

XX	Design	Size
1 x		335 mm
1 x		340 mm
1 x		1500 g
1 x		165 mm
1 x		160 mm
1 x		180 mm
1 x		200 mm
1 x		250 mm
3 x		140 · 180 · 230 mm
3 x		140 · 180 · 230 mm



V5638N-L, EAN 4047728078054

Soft foam insert · empty



V6015, EAN 4047728074667
Impact wrench · socket set for Series XL



XX	Design	Size
1 x	12.5 1/2	19 mm
1 x	12.5 1/2	17 mm
1 x	-	12.5 1/2
1 x	-	12.5 1/2
13 x	12.5 1/2	10 · 11 · 12 · 13 · 14 · 15 · 16 · 17 · 18 · 19 · 21 · 22 · 24 mm

XX	Design	Size
13 x	12.5 1/2	10 · 11 · 12 · 13 · 14 · 15 · 16 · 17 · 18 · 19 · 21 · 22 · 24 mm
5 x	12.5 1/2	15 · 17 · 19 · 21 · 22 mm
8 x	12.5 1/2	5 · 6 · 8 · 10 · 12 · 14 · 17 · 19 mm
8 x	12.5 1/2	M5 · M6 · M8 · M10 · M12 · M14 · M16 · M18
8 x	12.5 1/2	T30 · T40 · T45 · T50 · T55 · T60 · T70 · T80

V6015-L, EAN 4047728074056
Soft foam insert · empty



V7015N, EAN 4047728078818
Pliers and scraper set for Series XL



XX	Design	Size
1 x		800 g
1 x		300 mm
1 x		335 mm
1 x		340 mm
1 x		10 x
1 x		90 mm
1 x		165 mm
1 x		290 mm

XX	Design	Size
1 x		16 x
7 x		Ø 2 · 3 · 4 · 5 · 6 · 7 · 8 mm
2 x		Ø 4 · 40 mm
4 x		10 · 16 · 20 · 29 mm
2 x		170 · 190 mm
1 x		180 mm
1 x		200 mm
1 x		250 mm

V7015N-L, EAN 4047728078085
Soft foam insert · empty



V6816N, EAN 4047728078801
Pliers set

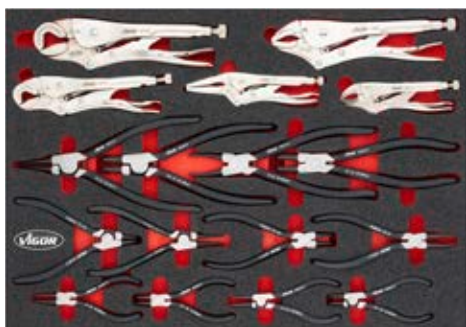

XX	Design	Size
1 x		150 mm
1 x		250 mm
1 x		125 mm
1 x		11 – 19 mm
1 x		16 – 27 mm

XX	Design	Size
3 x		140 · 180 · 230 mm
3 x		140 · 180 · 230 mm
3 x		140 · 180 · 230 mm
3 x		140 · 180 · 230 mm

V6816N-L, EAN 4047728078078
Soft foam insert · empty



Soft foam inserts



V5009, EAN 4047728050098
2-component soft foam insert ·
with empty compartment

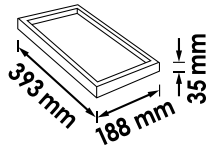

V4631, EAN 4047728046312
2-component soft foam insert ·
without cut-out

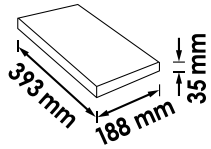

V5018, EAN 4047728050180
2-component soft foam insert ·
with empty compartment

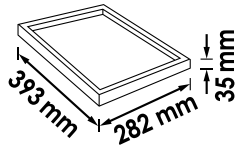

V4632, EAN 4047728046329
2-component soft foam insert ·
without cut-out

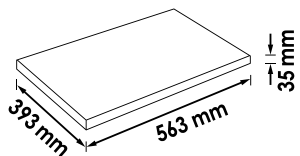

V4633, EAN 4047728064347
2-component soft foam insert ·
without cut-out

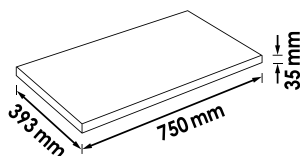

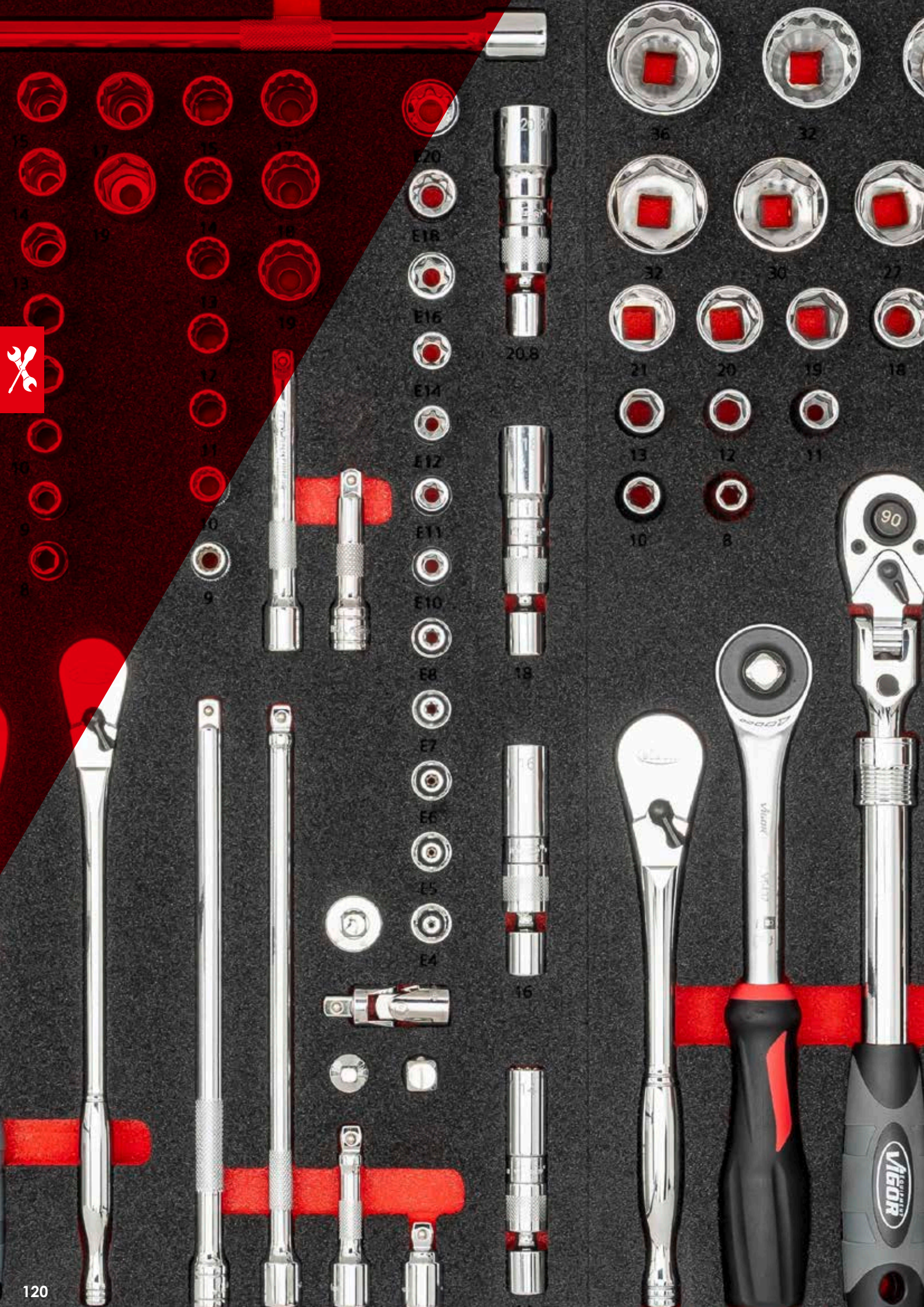

- 5
- 6
- 7
- 8
- 9
- 10
- 11
- 12
- 13
- 14
- 15
- 16
- 17
- 18
- 19
- 20

- E20
- E18
- E16
- E14
- E12
- E11
- E10
- E8
- E7
- E6
- E5
- E4

- 36
- 32
- 32
- 30
- 27
- 21
- 20
- 19
- 18
- 13
- 12
- 11
- 10
- 8

Hand tools

Sockets 122-175

Universal tool cases 176-177

Wrenches 178-185

Screwdrivers and bits 186-198

Pliers 199-208

VDE tools 209-212

Impact and loosening tools, scrapers 213-220

Various hand tools 220-221

Cutting and sawing 221-227



V5202, EAN 4047728**068987**

Socket set · super flat

- Flat insert profile – Direct attachment to the nut/screw connection
- Robust solid steel reversible ratchet
- Right and left-hand operation
- Ergonomic handle
- Sockets without chamfered edge
- Super short sockets make it possible to work in very tight spaces
- Through-hole sockets make it possible to work on stud bolts
- Sockets with outside hexagon size 11 mm for operation with box-end wrench or open-end wrench
- For manual operation

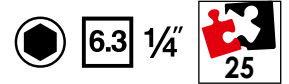

Including bit holder and bits

XX	■	●	Design	Size
3 x	6.3 1/4	●		0.8 x 4 · 1 x 5 · 1 x 6 mm
2 x	6.3 1/4	⊕		PH1 · PH2
5 x	6.3 1/4	⊗		T15 · T20 · T25 · T27 · T30
1 x	-	6.3 1/4		-
1 x	6.3 1/4	6.3 1/4		-
13 x	6.3 1/4	●		4 · 4.5 · 5 · 5.5 · 6 · 7 · 8 · 9 · 10 · 11 · 12 · 13 · 14 mm

V3734N, EAN 4047728**056427**

Socket set

- For manual operation



Single parts from page 124

XX	■	●	Design	Size
2 x	6.3 1/4	⊕		PH1 · PH2
2 x	6.3 1/4	⊕		PZ1 · PZ2
4 x	6.3 1/4	⊗		T15 · T20 · T25 · T30
1 x	6.3 1/4	6.3 1/4		25 mm
12 x	6.3 1/4	●		4 · 4.5 · 5 · 5.5 · 6 · 7 · 8 · 9 · 10 · 11 · 12 · 13 mm
1 x	-	6.3 1/4		150 mm
1 x	6.3 1/4	6.3 1/4		100 mm

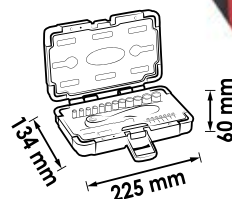

Sockets



V2414N, EAN 4047728056434

Socket set

• For manual operation



Single parts from page 124

XX	■	●	Design	Size
13 x	6.3 1/4	●		4 · 4.5 · 5 · 5.5 · 6 · 7 · 8 · 9 · 10 · 11 · 12 · 13 · 14 mm
3 x	6.3 1/4	●		0.8x4 · 1x5.5 · 1.2x7 mm
6 x	6.3 1/4	○		3 · 4 · 5 · 6 · 7 · 8 mm
3 x	6.3 1/4	+		PH1 · PH2 · PH3
3 x	6.3 1/4	+		PZ1 · PZ2 · PZ3
6 x	6.3 1/4	⊕		T10 · T15 · T20 · T25 · T30 · T40
2 x	-	○		1.3 · 2 mm
1 x	10 3/8	6.3 1/4		27 mm
1 x	6.3 1/4	6.3 1/4		110 mm
1 x	6.3 1/4	6.3 1/4		50 mm
1 x	6.3 1/4	6.3 1/4		100 mm
1 x	6.3 1/4	6.3 1/4		145 mm
1 x	6.3 1/4	6.3 1/4		40 mm
1 x	-	6.3 1/4		150 mm
1 x	-	6.3 1/4		150 mm



V7514/13, EAN 4047728074063

12-point socket set

• For manual operation

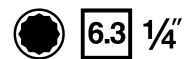

Single parts see page 127

XX	■	●	Design	Size
13 x	6.3 1/4	●		4 · 4.5 · 5 · 5.5 · 6 · 7 · 8 · 9 · 10 · 11 · 12 · 13 · 14 mm



V1897, EAN 4047728018975

Socket with multi-purpose profile, set

- For manual operation

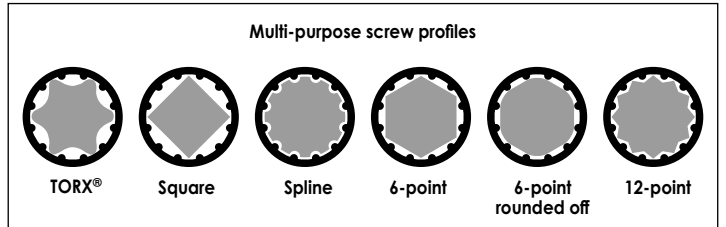
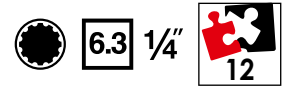

Single parts see page 128

XX	■	●	Design	Size
12 x	6.3 1/4	●		4 · 5 · 5.5 · 6 · 7 · 8 · 9 · 10 · 11 · 12 · 13 · 14 mm



All sockets suitable for 6 different profiles



V6014, EAN 4047728055833

Fine-tooth reversible ratchet

- Offset design
- Plastic coating
- Quick-release press-button
- 72 teeth
- 5° Opening angle
- For manual operation

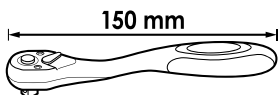

6.3 1/4

V6014-REP, EAN 4047728056519

Repair set

- Repair set for fine-tooth reversible ratchet V6014



V4944-S, EAN 4047728055345

Fine-tooth reversible ratchet · standard

- Robust and service-friendly
- Closed system
- Easy to clean
- 72 teeth
- 5° Opening angle
- For manual operation

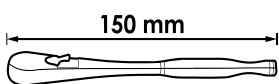

6.3 1/4

V4944-REP, EAN 4047728049474

Repair set

- Repair set for fine-tooth reversible ratchets V4944 · V4944-S · V4944-XS



Sockets



V4944-XS, EAN 4047728069557

Fine-tooth reversible ratchet · extra-short design

- Robust and service-friendly
- Closed system
- Easy to clean
- 72 teeth
- 5° Opening angle
- For manual operation



6.3 1/4"

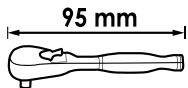

6.3 1/4"



V5436, EAN 4047728054362

360° rotary handle reversible ratchet

- Use in areas with restricted access
- Sliding square for clockwise/anti-clockwise operation
- Standard operation also possible through bolting
- Operation only clockwise
- 72 teeth
- 5° Opening angle
- For manual operation

Loosening and tightening of screw connections only in locked mode

6.3 1/4"



Actuator mechanism in the 360° rotary handle

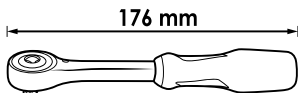

6.3 1/4"



V6614N, EAN 4047728080354

Telescopic reversible ratchet with hinge joint

- Telescopic range 175 – 225 mm
- 180° swivel head with locking mechanism
- Quick-release press-button
- 90 teeth
- 4° Opening angle
- For manual operation

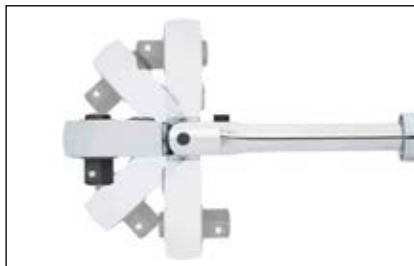

Latches in 5 positions

NEW

6.3 1/4"

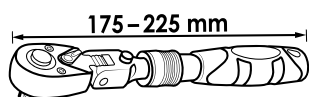

V6614N-REP, EAN 4047728081757

Repair set

- Repair set for telescopic reversible ratchet with hinge joint V6614N



V2941, EAN 4047728029414

Finger ratchet

- $\frac{1}{4}$ " $\frac{1}{4}$ " Finger ratchet, individual, for screwdriver bits
- 72 teeth
- 5° Opening angle
- For manual operation

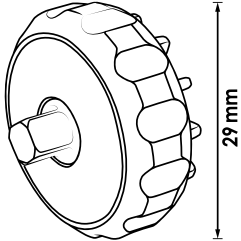

6.3 $\frac{1}{4}$ " **6.3** $\frac{1}{4}$ "



V2458N, EAN 4047728058179

Spin type speeder

- For manual operation



6.3 $\frac{1}{4}$ "



V2453N, EAN 4047728058124

Sliding T-handle

- For manual operation



6.3 $\frac{1}{4}$ " **6.3** $\frac{1}{4}$ "



Sockets



6-point socket



VIGOR No.	Size	mm	EAN 4047728+
V2413N	4 mm	25	057738
V2415N	4.5 mm	25	057745
V2416N	5 mm	25	057752
V2417N	5.5 mm	25	057769
V2418N	6 mm	25	057776
V2419N	7 mm	25	057783
V2420N	8 mm	25	057790

VIGOR No.	Size	mm	EAN 4047728+
V2421N	9 mm	25	057806
V2422N	10 mm	25	057813
V2423N	11 mm	25	057820
V2424N	12 mm	25	057837
V2425N	13 mm	25	057844
V2426N	14 mm	25	057851

12-point socket



VIGOR No.	Size	mm	EAN 4047728+
V7514-4	4 mm	25	074070
V7514-4.5	4.5 mm	25	074087
V7514-5	5 mm	25	074094
V7514-5.5	5.5 mm	25	074100
V7514-6	6 mm	25	074117
V7514-7	7 mm	25	074124
V7514-8	8 mm	25	074131

VIGOR No.	Size	mm	EAN 4047728+
V7514-9	9 mm	25	074148
V7514-10	10 mm	25	074155
V7514-11	11 mm	25	074162
V7514-12	12 mm	25	074179
V7514-13	13 mm	25	074186
V7514-14	14 mm	25	074193

6-point socket · long



VIGOR No.	Size	mm	EAN 4047728+
V2533N	4 mm	50	058193
V2534N	5 mm	50	058209
V2535N	6 mm	50	058216
V2536N	7 mm	50	058223
V2537N	8 mm	50	058230

VIGOR No.	Size	mm	EAN 4047728+
V2538N	9 mm	50	058247
V2539N	10 mm	50	058254
V2699N	11 mm	50	058735
V2700N	12 mm	50	058742
V2701N	13 mm	50	058759

12-point socket · long

NEW



VIGOR No.	Size	EAN 4047728+
V7514L-4	4 mm	080514
V7514L-5	5 mm	080521
V7514L-5.5	5.5 mm	080538
V7514L-6	6 mm	080545
V7514L-7	7 mm	080552
V7514L-8	8 mm	080569

VIGOR No.	Size	EAN 4047728+
V7514L-9	9 mm	080576
V7514L-10	10 mm	080583
V7514L-11	11 mm	080590
V7514L-12	12 mm	080606
V7514L-13	13 mm	080613

T socket

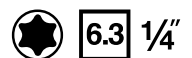

VIGOR No.	Size	mm	EAN 4047728+
V2185	E4	24.8	021852
V2186	E5	24.8	021869
V2187	E6	24.8	021876
V2188	E7	24.8	021883
V2189	E8	24.8	021890
V2722	E10	24.8	027229
V2723	E11	24.8	027236



T-Plus socket



VIGOR No.	Size	EAN 4047728+
V7920-EP4	E4+	078146
V7920-EP5	E5+	078153
V7920-EP6	E6+	078160
V7920-EP7	E7+	078177
V7920-EP8	E8+	078184

Socket with multi-purpose profile



VIGOR No.	Size	L mm	EAN 4047728+
V1976	4 mm	25	019767
V1977	5 mm	25	019774
V1978	5.5 mm	25	019781
V1979	6 mm	25	019798
V1980	7 mm	25	019804
V1981	8 mm	25	019811

VIGOR No.	Size	L mm	EAN 4047728+
V1982	9 mm	25	019828
V1983	10 mm	25	019835
V1984	11 mm	25	019842
V1985	12 mm	25	019859
V1986	13 mm	25	019866
V1987	14 mm	25	019873

T screwdriver socket



VIGOR No.	Size	L mm	EAN 4047728+
V2595N	T9	38	058599
V2442N	T10	38	058018
V2443N	T15	38	058025
V2444N	T20	38	058032

VIGOR No.	Size	L mm	EAN 4047728+
V2445N	T25	38	058049
V2130N	T27	38	057042
V2446N	T30	38	058056
V2447N	T40	38	058063

T-Plus screwdriver socket



VIGOR No.	Size	EAN 4047728+
V7037-IP8	T8+	078276
V7037-IP10	T10+	078283
V7037-IP15	T15+	078290
V7037-IP20	T20+	078306
V7037-IP25	T25+	078313
V7037-IP27	T27+	078320
V7037-IP30	T30+	078337

T screwdriver socket



VIGOR No.	Size	L mm	EAN 4047728+
V7037-T8H	T8H	37	082310
V2596N	T9H	37	058605
V2136	T10H	37	021364
V2138	T15H	37	021388
V2139	T20H	37	021395
V2140	T25H	37	021401
V2141	T27H	37	021418
V2142	T30H	37	021425

Sockets



T-Plus screwdriver socket



VIGOR No.	Size	EAN 4047728+
V7037-IPR8	T8+H	078399
V7037-IPR10	T10+H	078405
V7037-IPR15	T15+H	078412
V7037-IPR20	T20+H	078429
V7037-IPR25	T25+H	078436
V7037-IPR27	T27+H	078443
V7037-IPR30	T30+H	078450

Screwdriver socket



VIGOR No.	Size	mm	EAN 4047728+
V2593N	PH0	38	058575
V2436N	PH1	38	057950
V2437N	PH2	38	057967
V2438N	PH3	38	057974

Screwdriver socket



VIGOR No.	Size	mm	EAN 4047728+
V2594N	PZ0	38	058582
V2439N	PZ1	38	057981
V2440N	PZ2	38	057998
V2441N	PZ3	38	058001

Screwdriver socket



VIGOR No.	Size	mm	EAN 4047728+
V2427N	0.8x4 mm	38	057868
V2428N	1x5.5 mm	38	057875
V2597N	1.2x6.5 mm	38	058612
V2429N	1.2x7 mm	38	057882

Screwdriver socket for inside hexagon screws



VIGOR No.	Size	mm	EAN 4047728+
V2430N	3 mm	38	057899
V2431N	4 mm	38	057905
V2432N	5 mm	38	057912
V2433N	6 mm	38	057929
V2434N	7 mm	38	057936
V2435N	8 mm	38	057943



Flexible extension

6.3 1/4" 6.3 1/4"



VIGOR No.	mm	EAN 4047728+
V2457N	145	058162

Wobble extension

- Operating screw connections in confined spaces and working in areas with restricted access
- Spherical, tapered outside square

6.3 1/4" 6.3 1/4"



VIGOR No.	mm	EAN 4047728+
V4311	36	043113
V4312	75	043120
V4313	250	043137

Extension

6.3 1/4" 6.3 1/4"



VIGOR No.	mm	EAN 4047728+
V2455N	50	058148
V2456N	100	058155

Sockets



Universal joint

6.3 1/4 6.3 1/4



VIGOR No.	mm	EAN 4047728+
V2454N	40	058131

Adapter

10 3/8 6.3 1/4



VIGOR No.	mm	EAN 4047728+
V2014	26	020145

Adapter

6.3 1/4 6.3 1/4



VIGOR No.	mm	EAN 4047728+
V2452N	25	058117

Bit adapter

6.3 1/4 6.3 1/4



VIGOR No.	mm	EAN 4047728+
V3651N	25	058872

Follow us on

Instagram 

vigor_equipment_official



V6202, EAN 4047728062022

Socket set · super flat

- Thanks to insert profile – direct attachment to the nut/screw connection
- Robust solid steel reversible ratchet
- Right and left-hand operation
- Ergonomic handle
- Sockets without chamfered edge
- Super short sockets make it possible to work in very tight spaces
- Sockets with outside hexagon size 17 mm for operation with box-end wrench or open-end wrench
- For manual operation

Your problem solver for flat screw connections and tight spaces

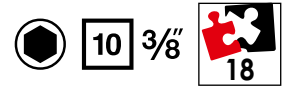

Without chamfered edge
For low screw head heights

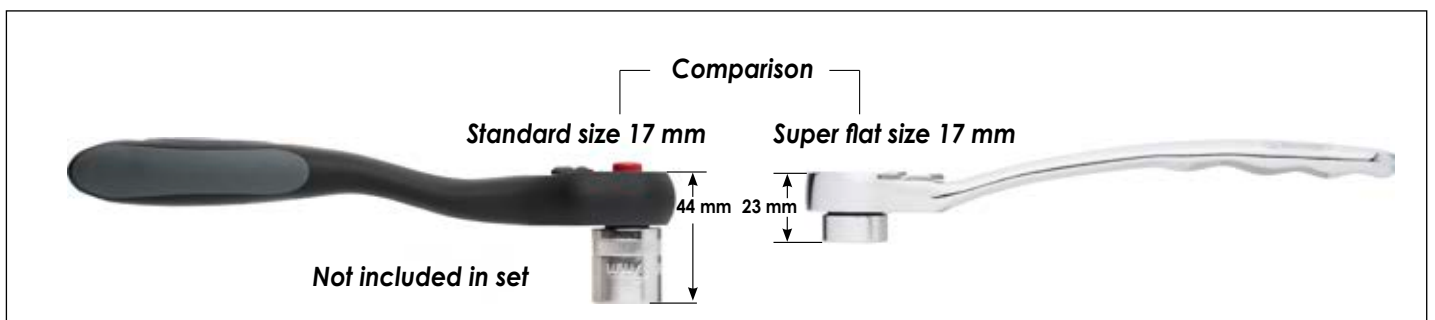

Quantity	Design	Size
1 x		200 mm
1 x		30 mm
1 x		60 mm
1 x		75 mm
1 x		150 mm
13 x		8 · 9 · 10 · 11 · 12 · 13 · 14 · 15 · 16 · 17 · 19 · 21 · 22 mm



Sockets



V2305N, EAN 4047728056441

Socket set

• For manual operation

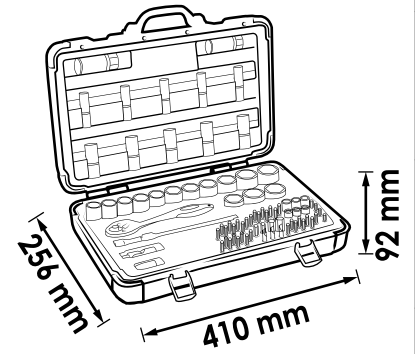

Single parts from page 135

XX	■	●	Design	Size
18 x	10 3/8	●		6 · 7 · 8 · 9 · 10 · 11 · 12 · 13 · 14 · 15 · 16 · 17 · 18 · 19 · 20 · 21 · 22 · 24 mm
10 x	10 3/8	●		8 · 9 · 10 · 11 · 12 · 13 · 14 · 15 · 17 · 19 mm
2 x	10 3/8	●		16 · 21 mm
7 x	10 3/8	○		3 · 4 · 5 · 6 · 7 · 8 · 10 mm
3 x	10 3/8	●		0.8x5.5 · 1x7 · 1.2x8 mm
3 x	10 3/8	+		PH1 · PH2 · PH3
3 x	10 3/8	+		PZ1 · PZ2 · PZ3
9 x	10 3/8	⊗		T15 · T20 · T25 · T27 · T30 · T40 · T45 · T50 · T55
1 x	10 3/8	⊗		28 mm
1 x	12 1/2	10 3/8		40 mm
1 x	10 3/8	10 3/8		75 mm
1 x	10 3/8	10 3/8		250 mm
1 x	10 3/8	10 3/8		50 mm
1 x	-	10 3/8		198 mm



V7538/10, EAN 4047728074209

12-point socket set

- For manual operation

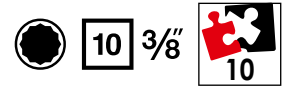

Single parts see page 136

XX	■	●	Design	Size
10 x	10 3/8	●		10 · 11 · 12 · 13 · 14 · 15 · 16 · 17 · 18 · 19 mm



V6017, EAN 4047728064361

T screwdriver socket set

- Phosphatized blades
- Chrome-vanadium steel
- Knurling
- For manual operation

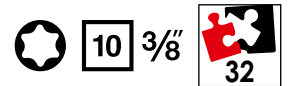

Single parts from page 138

XX	■	●	Design	Size
8 x	10 3/8	●		T20 · T25 · T27 · T30 · T40 · T45 · T50 · T55
2 x	10 3/8	●		T60 · T70
10 x	10 3/8	●		T20 · T25 · T27 · T30 · T40 · T45 · T50 · T55 · T60 · T70
6 x	10 3/8	●		T40 · T45 · T50 · T55 · T60 · T70
6 x	10 3/8	●		T40 · T45 · T50 · T55 · T60 · T70



V6018, EAN 4047728065894

Screwdriver socket set for screws with internal serration (XZN)

- Phosphatized blades
- Chrome-vanadium steel
- Knurling
- For manual operation

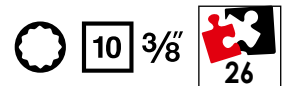

Single parts see page 140

XX	■	●	Design	Size
8 x	10 3/8	●		M5 · M6 · M8 · M9 · M10 · M12 · M14 · M16
7 x	10 3/8	●		M5 · M6 · M8 · M9 · M10 · M12 · M14
7 x	10 3/8	●		M5 · M6 · M8 · M9 · M10 · M12 · M14
4 x	10 3/8	●		M8 · M10 · M12 · M14



V6019, EAN 4047728065900

Screwdriver socket set for inside hexagon screws

- Phosphatized blades
- Chrome-vanadium steel
- Knurling
- For manual operation

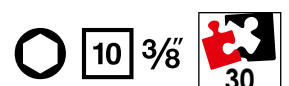

Single parts see page 141

XX	■	●	Design	Size
9 x	10 3/8	●		5 · 6 · 7 · 8 · 10 · 12 · 14 · 17 · 19 mm
8 x	10 3/8	●		5 · 6 · 7 · 8 · 10 · 11 · 12 · 13 mm
7 x	10 3/8	●		5 · 6 · 7 · 8 · 10 · 12 · 14 mm
6 x	10 3/8	●		5 · 6 · 7 · 8 · 10 · 12 mm



Sockets



V6038, EAN 4047728055840

Fine-tooth reversible ratchet

- Offset design
- Plastic coating
- Quick-release press-button
- DIN 3122, ISO 3315
- 72 teeth
- 5° Opening angle
- For manual operation



10 3/8"

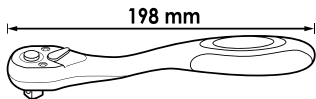

10 3/8"



V6038-REP, EAN 4047728056526

Repair set

- Repair set for fine-tooth reversible ratchet V6038



10 3/8"



V6638N, EAN 4047728080347

Telescopic reversible ratchet with hinge joint

- Telescopic range 250 – 350 mm
- 180° swivel head with locking mechanism
- Quick-release press-button
- 90 teeth
- 4° Opening angle
- For manual operation



10 3/8"



Latches in 5 positions

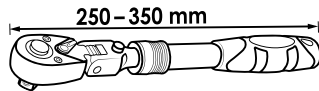

V6638N-REP, EAN 4047728081740

Repair set

- Repair set for telescopic reversible ratchet with hinge joint V6638N



V4945-S, EAN 4047728055352

Fine-tooth reversible ratchet · standard

- Robust and service-friendly
- Closed system
- Easy to clean
- 72 teeth
- 5° Opening angle
- For manual operation



10 3/8"

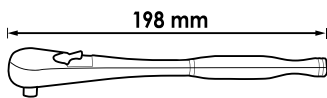

10 3/8"



V4945-REP, EAN 4047728049481

Repair set

- Repair set for fine-tooth reversible ratchets V4945 · V4945-S



V6008, EAN 4047728060080

360° rotary handle reversible ratchet

- Use in areas with restricted access
- Sliding square for clockwise/anti-clockwise operation
- Standard operation also possible through bolting
- Operation only clockwise
- 72 teeth
- 5° Opening angle
- For manual operation

Loosening and tightening of screw connections only in locked mode



10 3/8"



Actuator mechanism in the 360° rotary handle

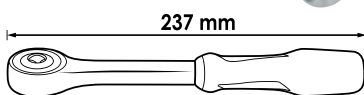

10 3/8"



6-point socket

10 3/8"

VIGOR No.	Size	L mm	EAN 4047728+
V2278N	6 mm	28	057219
V2277N	7 mm	28	056908
V2276N	8 mm	28	056892
V2275N	9 mm	28	056885
V2274N	10 mm	28	056878
V2273N	11 mm	28	056861
V2272N	12 mm	28	056854
V2271N	13 mm	28	056847
V2270N	14 mm	28	056830

VIGOR No.	Size	L mm	EAN 4047728+
V2269N	15 mm	28	057141
V2268N	16 mm	28	057134
V2267N	17 mm	30	057127
V2266N	18 mm	30	057110
V2265N	19 mm	30	057103
V2264N	20 mm	30	057097
V2263N	21 mm	30	057080
V2262N	22 mm	30	057073
V2261N	24 mm	30	057066

12-point socket

10 3/8"

VIGOR No.	Size	L mm	EAN 4047728+
V7538-9	9 mm	28	080439
V7538-10	10 mm	28	074230
V7538-11	11 mm	28	074247
V7538-12	12 mm	28	074254
V7538-13	13 mm	28	074261
V7538-14	14 mm	28	074278
V7538-15	15 mm	28	074285
V7538-16	16 mm	28	074292
V7538-17	17 mm	30	074308
V7538-18	18 mm	30	074315
V7538-19	19 mm	30	074322

6-point socket · long

10 3/8"

VIGOR No.	Size	L mm	EAN 4047728+
V2016N	8 mm	63	056922
V2017N	9 mm	63	056939
V2018N	10 mm	63	056946
V2019N	11 mm	63	056953
V2020N	12 mm	63	056960
V2311N	13 mm	63	057509
V2312N	14 mm	63	057516
V2313N	15 mm	63	057523
V2314N	17 mm	63	057530
V2315N	19 mm	63	057547

12-point socket · long

NEW

10 3/8"

VIGOR No.	Size	EAN 4047728+
V7538L-9	9 mm	080644
V7538L-10	10 mm	080651
V7538L-11	11 mm	080668
V7538L-12	12 mm	080675
V7538L-13	13 mm	080682
V7538L-14	14 mm	080699
V7538L-15	15 mm	080705
V7538L-16	16 mm	080712
V7538L-17	17 mm	080729
V7538L-18	18 mm	080736
V7538L-19	19 mm	080743

T socket



VIGOR No.	Size	mm	EAN 4047728+
V2724	E4	28	027243
V2725	E5	28	027250
V2726	E6	28	027267
V2727	E7	28	027274
V2728	E8	28	027281
V2143	E10	28	021432

VIGOR No.	Size	mm	EAN 4047728+
V2614N	E11	28	058674
V2144	E12	28	021449
V2145	E14	28	021456
V2146	E16	28	021463
V2615N	E18	28	058681
V2729	E20	28	027298

T-Plus socket



VIGOR No.	Size	EAN 4047728+
V7920-EP10	E10+	078191
V7920-EP12	E12+	078207
V7920-EP14	E14+	078214
V7920-EP16	E16+	078221

Spark plug socket



VIGOR No.	Size	mm	EAN 4047728+
V2119N	16 mm	66	057028
V2613N	18 mm	66	058667
V2120N	21 mm	66	057035

Screwdriver socket



VIGOR No.	Size	mm	EAN 4047728+
V2288N	0.8x5.5 mm	49	057318
V2287N	1x7 mm	49	057301
V2286N	1.2x8 mm	49	057295



Screwdriver socket



VIGOR No.	Size	Length mm	EAN 4047728+
V2291N	PZ1	49	057349
V2290N	PZ2	49	057332
V2289N	PZ3	49	057325

Screwdriver socket



VIGOR No.	Size	Length mm	EAN 4047728+
V2294N	PH1	49	057370
V2293N	PH2	49	057363
V2292N	PH3	49	057356

T screwdriver socket



VIGOR No.	Size	Length mm	EAN 4047728+
V2194	T45H	48	021944
V2195	T50H	48	021951

T screwdriver socket



VIGOR No.	Size	Length mm	EAN 4047728+
V6082	T60	49	060820
V6083	T70	49	060837

Sockets



T screwdriver socket



VIGOR No.	Size	L mm	EAN 4047728+
V2303N	T15	49	057493
V2302N	T20	49	057486
V2301N	T25	49	057479
V2300N	T27	49	057462
V2299N	T30	49	057455
V2298N	T40	49	057448
V2297N	T45	49	057431
V2149	T47	49	021494
V2296N	T50	49	057394
V2295N	T55	49	057387

T screwdriver socket



VIGOR No.	Size	L mm	EAN 4047728+
V6084	T20	93	060844
V6085	T25	93	060851
V6086	T27	93	060868
V6087	T30	93	060875
V6088	T40	93	060882
V6089	T45	93	060899
V6090	T50	93	060905
V6091	T55	93	060912
V6092	T60	93	060929
V6093	T70	93	060936

T screwdriver socket



VIGOR No.	Size	L mm	EAN 4047728+
V6094	T40	133	060943
V6095	T45	133	060950
V6096	T50	133	060967
V6097	T55	133	060974
V6098	T60	133	060981
V6099	T70	133	060998

T screwdriver socket



VIGOR No.	Size	L mm	EAN 4047728+
V6100	T40	193	061001
V6101	T45	193	061018
V6102	T50	193	061025
V6103	T55	193	061032
V6104	T60	193	061049
V6105	T70	193	061056



Screwdriver socket for screws with internal serration (XZN)



VIGOR No.	Size	L mm	EAN 4047728+
V6106	M5	48	061063
V6107	M6	48	061070
V6108	M8	48	061087
V6109	M9	48	061094
V6110	M10	48	061100
V6111	M12	48	061117
V6112	M14	48	061124
V6113	M16	48	061131

Screwdriver socket for screws with internal serration (XZN)



VIGOR No.	Size	L mm	EAN 4047728+
V6114	M5	93	061148
V6115	M6	93	061155
V6116	M8	93	061162
V6117	M9	93	061179
V6118	M10	93	061186
V6119	M12	93	061193
V6120	M14	93	061209

Screwdriver socket for screws with internal serration (XZN)



VIGOR No.	Size	L mm	EAN 4047728+
V6121	M5	133	061216
V6122	M6	133	061223
V6123	M8	133	061230
V6124	M9	133	061247
V6125	M10	133	061254
V6126	M12	133	061261
V6127	M14	133	061278

Screwdriver socket for screws with internal serration (XZN)



VIGOR No.	Size	L mm	EAN 4047728+
V6128	M8	193	061285
V6129	M10	193	061292
V6130	M12	193	061308
V6131	M14	193	061315

Sockets



Screwdriver socket for inside hexagon screws



VIGOR No.	Size	L mm	EAN 4047728+
V2285N	3 mm	49	057288
V2284N	4 mm	49	057271
V2283N	5 mm	49	057264
V2282N	6 mm	49	057257
V2281N	7 mm	49	057240
V2280N	8 mm	49	057233
V2279N	10 mm	49	057226
V6137	12 mm	49	061377
V6138	14 mm	49	061384
V6139	17 mm	49	061391
V6140	19 mm	49	061407

Screwdriver socket for inside hexagon screws



VIGOR No.	Size	L mm	EAN 4047728+
V6141	5 mm	93	061414
V6142	6 mm	93	061421
V6143	7 mm	93	061438
V6144	8 mm	93	061445
V6145	10 mm	93	061452
V6146	11 mm	93	061469
V6147	12 mm	93	061476
V6148	13 mm	93	061483

Screwdriver socket for inside hexagon screws



VIGOR No.	Size	L mm	EAN 4047728+
V6149	5 mm	133	061490
V6194	6 mm	133	062466
V6151	7 mm	133	061513
V6152	8 mm	133	061520
V6153	10 mm	133	061537
V6154	12 mm	133	061544
V6155	14 mm	133	061551

Screwdriver socket for inside hexagon screws



VIGOR No.	Size	L mm	EAN 4047728+
V6156	5 mm	193	061568
V6157	6 mm	193	061575
V6158	7 mm	193	061582
V6159	8 mm	193	061599
V6160	10 mm	193	061605
V6161	12 mm	193	061612



Universal joint

10 3/8 10 3/8



VIGOR No.	mm	EAN 4047728+
V2118N	50	057011

Extension

10 3/8 10 3/8



VIGOR No.	mm	EAN 4047728+
V2115N	75	056984
V2616N	125	058698
V2117N	250	057004

Wobble extension

- Operating screw connections in confined spaces and working in areas with restricted access
- Spherical, tapered outside square
- Angular movement to each side 8°

10 3/8 10 3/8



VIGOR No.	mm	EAN 4047728+
V4314	36	043144
V4315	75	043151
V4316	250	043168



Sockets



Sliding head / adapter

10 3/8 **12⁵ 1/2**



VIGOR No.	mm	EAN 4047728+
V2116N	40	056991

Bit adapter

8 5/16 **10 3/8**



VIGOR No.	mm	EAN 4047728+
V2114N	28	056977

Adapter

6.3 1/4 **10 3/8**



VIGOR No.	mm	EAN 4047728+
V2071	27	020718

Adapter

12⁵ 1/2 **10 3/8**



VIGOR No.	mm	EAN 4047728+
V2108	36	021081

Bit adapter

10 3/8 **8 5/16**



VIGOR No.	mm	EAN 4047728+
V3652N	30	058889



V7202, EAN 4047728**068888**

Socket set · super flat

- Robust solid steel reversible ratchet
- Right and left-hand operation
- Ergonomic handle
- Sockets without chamfered edge
- Super short sockets make it possible to work in very tight spaces
- Through-hole sockets make it possible to work on stud bolts
- Sockets with outside hexagon size 22 mm for operation with box-end wrench or open-end wrench
- For manual operation

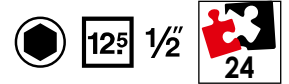

XX	■	□	Design	Size
1 x	-	12 5/8		-
1 x	22 mm	12 5/8		-
1 x	12 5/8	12 5/8		-
1 x	12 5/8	12 5/8		125 mm
1 x	12 5/8	12 5/8		250 mm
19 x	12 5/8	●		8 · 9 · 10 · 11 · 12 · 13 · 14 · 15 · 16 · 17 · 18 · 19 · 20 · 21 · 22 · 24 · 27 · 30 · 32 mm



V2460N, EAN 4047728**056458**

Socket set

- For manual operation

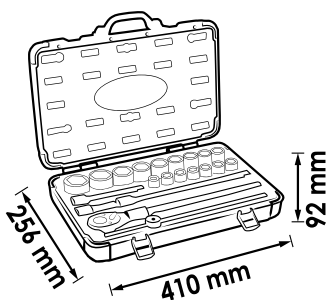
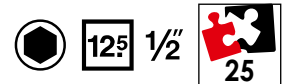

Single parts from page 154

XX	■	□	Design	Size
18 x	12 5/8	●		10 · 11 · 12 · 13 · 14 · 15 · 16 · 17 · 18 · 19 · 20 · 21 · 22 · 23 · 24 · 27 · 30 · 32 mm
2 x	12 5/8	●		16 · 21 mm
1 x	-	12 5/8		250 mm
1 x	12 5/8	12 5/8		125 mm
1 x	12 5/8	12 5/8		250 mm
1 x	12 5/8	12 5/8		75 mm
1 x	-	12 5/8		250 mm



Sockets



V7512/17, EAN 4047728074216

12-point socket set

• For manual operation



12⁵ 1/2"



Single parts see page 156

XX	■	●	Design	Size
18 x	12 ⁵ 1/2"	●		8 · 10 · 11 · 12 · 13 · 14 · 15 · 16 · 17 · 18 · 19 · 20 · 21 · 22 · 24 · 27 · 30 · 32 mm



V2496, EAN 4047728024969

Screwdriver socket set

• For manual operation



12⁵ 1/2"



Single parts from page 158

XX	■	●	Design	Size
8 x	12 ⁵ 1/2"	○		M5 · M6 · M8 · M9 · M10 · M12 · M14 · M16
9 x	12 ⁵ 1/2"	○		5 · 6 · 7 · 8 · 10 · 12 · 14 · 17 · 19 mm
9 x	12 ⁵ 1/2"	●		M5 · M6 · M7 · M8 · M9 · M10 · M12 · M13 · M14
10 x	12 ⁵ 1/2"	●		T20 · T25 · T27 · T30 · T40 · T45 · T50 · T55 · T60 · T70



V1917, EAN 4047728019170

T screwdriver socket set

• For manual operation



Single parts from page 159

XX	■	⊗	Design	Size
10 x	12.5	1/2		T20 · T25 · T27 · T30 · T40 · T45 · T50 · T55 · T60 · T70
10 x	12.5	1/2		T20 · T25 · T27 · T30 · T40 · T45 · T50 · T55 · T60 · T70
6 x	12.5	1/2		T40 · T45 · T50 · T55 · T60 · T70
6 x	12.5	1/2		T40 · T45 · T50 · T55 · T60 · T70



V1918, EAN 4047728019187

Screwdriver socket set for screws with internal serration (XZN)

• For manual operation



Single parts from page 158

XX	■	⊗	Design	Size
8 x	12.5	1/2		M5 · M6 · M8 · M9 · M10 · M12 · M14 · M16
7 x	12.5	1/2		M5 · M6 · M8 · M9 · M10 · M12 · M14
7 x	12.5	1/2		M5 · M6 · M8 · M10 · M12 · M14 · M9
4 x	12.5	1/2		M8 · M10 · M12 · M14



Sockets



V1919, EAN 4047728019194

Screwdriver socket set for inside hexagon screws

• For manual operation

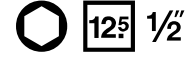

Single parts from page 158

XX	■	○	Design	Size
9 x	12 5/8	○		5 · 6 · 7 · 8 · 10 · 12 · 14 · 17 · 19 mm
8 x	12 5/8	○		5 · 6 · 7 · 8 · 10 · 11 · 12 · 13 mm
7 x	12 5/8	○		5 · 6 · 7 · 8 · 10 · 12 · 14 mm
6 x	12 5/8	○		5 · 6 · 7 · 8 · 10 · 12 mm



V2201, EAN 4047728022019

RIBE screwdriver socket set

• For manual operation



Single parts see page 161

XX	■	○	Design	Size
9 x	12 5/8	⊛		M5 · M6 · M7 · M8 · M9 · M10 · M12 · M13 · M14
9 x	12 5/8	⊛		M5 · M6 · M7 · M8 · M9 · M10 · M12 · M13 · M14
7 x	12 5/8	⊛		M8 · M9 · M10 · M10.3 · M12 · M13 · M14
7 x	12 5/8	⊛		M8 · M9 · M10 · M10.3 · M12 · M13 · M14



V7917, EAN 4047728**075831**

T ball-head screwdriver socket set

- Angular movement: 20°
- For manual operation



12⁵ 1/2"



Single parts from page 161

XX	■	⊙	Design	Size
8 x	12 ⁵ 1/2"	⊙		T20 · T25 · T27 · T30 · T40 · T45 · T50 · T55
2 x	12 ⁵ 1/2"	⊙		T60 · T70
10 x	12 ⁵ 1/2"	⊙		T20 · T25 · T27 · T30 · T40 · T45 · T50 · T55 · T60 · T70
6 x	12 ⁵ 1/2"	⊙		T40 · T45 · T50 · T55 · T60 · T70
6 x	12 ⁵ 1/2"	⊙		T40 · T45 · T50 · T55 · T60 · T70



V7919, EAN 4047728**075817**

Ball-head screwdriver socket set for inside hexagon screws

- Angular movement: 20°
- For manual operation



12⁵ 1/2"



Single parts from page 162

XX	■	⊙	Design	Size
7 x	12 ⁵ 1/2"	⊙		5 · 6 · 7 · 8 · 10 · 12 · 14 mm
2 x	12 ⁵ 1/2"	⊙		17 · 19 mm
8 x	12 ⁵ 1/2"	⊙		5 · 6 · 7 · 8 · 10 · 11 · 12 · 13 mm
7 x	12 ⁵ 1/2"	⊙		5 · 6 · 7 · 8 · 10 · 12 · 14 mm
6 x	12 ⁵ 1/2"	⊙		5 · 6 · 7 · 8 · 10 · 12 mm



Sockets



V1898, EAN 4047728018982

Socket with multi-purpose profile, set

• For manual operation

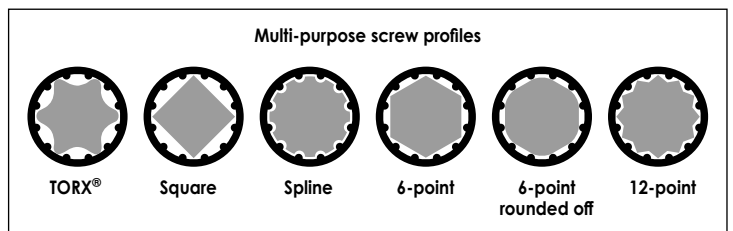
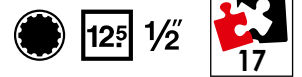

All sockets suitable for 6 different profiles

Single parts see page 157

XX	■	●	Design	Size
17 x	12.5 1/2	●		10 · 11 · 12 · 13 · 14 · 15 · 16 · 17 · 18 · 19 · 20 · 21 · 22 · 24 · 27 · 30 · 32 mm



V6412/4, EAN 4047728079518

Stud extractor set

- Damage-free insertion and removal of studs and threaded pins
- For left and right-hand threads
- Outside hexagon drive 19 or 22 mm
- Sizes: 6 · 8 · 10 · 12 mm
- For manual operation



NEW



V2404N, EAN 4047728080507

Extractor socket set with spiral profile

- Operation of nuts with damaged heads (special profile)
- For manual operation

NEW

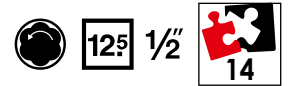

Single parts see page 165

XX	■	●	Design	Size
13 x	12.5 1/2	●		6 · 7 · 8 · 9 · 10 · 11 · 12 · 13 · 14 · 15 · 16 · 17 · 19 mm



V3741, EAN 4047728037419

Extractor socket set with spiral profile

- Operation of nuts with damaged heads (special profile)
- For manual operation

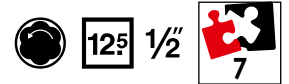

Single parts see page 165

XX	■	●	Design	Size
6 x	12.5 1/2	●		21 · 22 · 24 · 27 · 30 · 32 mm



Sockets



V5550S, EAN 4047728**055819**

Impact socket set · short

- Surface: phosphatized
- For impact operation

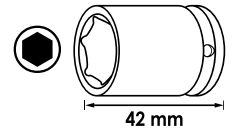
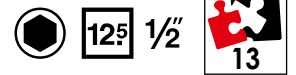

Single parts see page 165

XX	■	●	Design	Size
13 x	12.5 1/2	●		10 · 11 · 12 · 13 · 14 · 15 · 16 · 17 · 18 · 19 · 21 · 22 · 24 mm



V5550L, EAN 4047728**055505**

Impact socket set · long

- Surface: phosphatized
- For impact operation

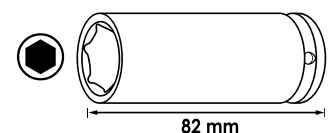
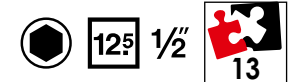

Single parts see page 165

XX	■	●	Design	Size
13 x	12.5 1/2	●		10 · 11 · 12 · 13 · 14 · 15 · 16 · 17 · 18 · 19 · 21 · 22 · 24 mm



V7019, EAN 4047728**066372**

Impact screwdriver socket set for inside hexagon profile

- Surface: phosphatized
- For impact operation

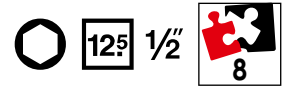

Single parts see page 166

XX	■	○	Design	Size
8 x	12.5 1/2	○		5 · 6 · 8 · 10 · 12 · 14 · 17 · 19 mm



V7018, EAN 4047728**066846**

Impact screwdriver socket set for internal serration profile (XZN)

- Surface: phosphatized
- For impact operation

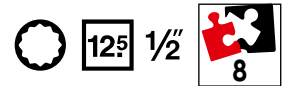

Single parts see page 166

XX	■	○	Design	Size
8 x	12.5 1/2	○		M5 · M6 · M8 · M10 · M12 · M14 · M16 · M18



Sockets



V7017, EAN 4047728**064705**
Impact screwdriver socket set for internal T profile

- Surface: phosphatized
- For impact operation



12⁵ 1/2"



Single parts see page 165

XX	■	Design	Size
8 x	12 ⁵ 1/2"		T30 · T40 · T45 · T50 · T55 · T60 · T70 · T80



V6012, EAN 4047728055826

Fine-tooth reversible ratchet

- Offset design
- Plastic coating
- Quick-release press-button
- DIN 3122, ISO 3315
- 72 teeth
- 5° Opening angle
- For manual operation

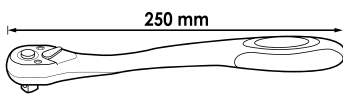
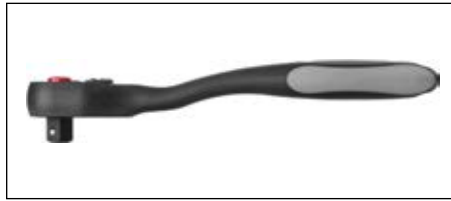

12.5 1/2

V6012-REP, EAN 4047728056533

Repair set

- Repair set for fine-tooth reversible ratchet V6012 · V6612



V4946-S, EAN 4047728055369

Fine-tooth reversible ratchet · standard

- Robust and service-friendly
- Closed system
- Easy to clean
- DIN 3122, ISO 3315
- 72 teeth
- 5° Opening angle
- For manual operation



Closed system



Sturdy solid steel design

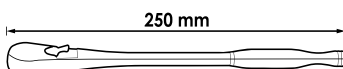

12.5 1/2

V4946-REP, EAN 4047728049498

Repair set

- Repair set for fine-tooth reversible ratchets V4946 · V4946-S



V4884, EAN 4047728048842

Flexible handle with reversible ratchet

- Square drive with ball locking device
- DIN 3122
- 24 teeth
- 15° Opening angle
- For manual operation



Robust 24-tooth ratchet mechanism



180°

12.5 1/2

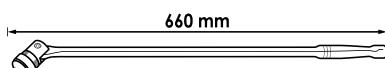

12.5 1/2

V4884-01, EAN 4047728073226

Ratchet head



Sockets



V5437, EAN 4047728**054379**

360° rotary handle reversible ratchet

- Use in areas with restricted access
- Sliding square for clockwise/anti-clockwise operation
- Standard operation also possible through bolting
- Operation only clockwise
- 72 teeth
- 5° Opening angle
- For manual operation



Loosening and tightening of screw connections only in locked mode

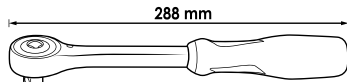

12.5 1/2



V6612N, EAN 4047728**080330**

Telescopic reversible ratchet with hinge joint

- Telescopic range 350 – 490 mm
- 180° swivel head with locking mechanism
- Quick-release press-button
- 90 teeth
- 4° Opening angle
- For manual operation



Latches in 5 positions

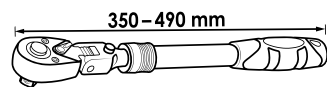

V6612N-REP, EAN 4047728**081733**

Repair set

- Repair set for telescopic reversible ratchet with hinge joint V6612N



Sliding T-handle

12.5 1/2



VIGOR No.	mm	EAN 4047728+
V2573N	250	058391

Sliding piece

12.5 1/2



VIGOR No.	mm	EAN 4047728+
V2667N	43.7	058728



6-point socket



VIGOR No.	Size	L mm	EAN 4047728+
V4709N	8 mm	38	058902
V2465N	10 mm	38	058186
V2598N	11 mm	38	058629
V2603N	12 mm	38	058650
V2599N	13 mm	38	058636
V2600N	14 mm	38	058643
V2561N	15 mm	38	058261
V2562N	16 mm	38	058278
V2563N	17 mm	38	058285
V2564N	18 mm	38	058292

VIGOR No.	Size	L mm	EAN 4047728+
V2565N	19 mm	38	058308
V2566N	20 mm	38	058315
V2567N	21 mm	38	058322
V2568N	22 mm	38	058339
V2569N	23 mm	38	058346
V2570N	24 mm	38	058353
V2571N	27 mm	42	058360
V2572N	30 mm	44	058377
V2574N	32 mm	44	058384

12-point socket



VIGOR No.	Size	L mm	EAN 4047728+
V7512-8	8 mm	38	074339
V7512-9	9 mm	38	080446
V7512-10	10 mm	38	074346
V7512-11	11 mm	38	074353
V7512-12	12 mm	38	074360
V7512-13	13 mm	38	074377
V7512-14	14 mm	38	074384
V7512-15	15 mm	38	074391
V7512-16	16 mm	38	074407
V7512-17	17 mm	38	074414
V7512-18	18 mm	38	074421

VIGOR No.	Size	L mm	EAN 4047728+
V7512-19	19 mm	38	074438
V7512-20	20 mm	38	074445
V7512-21	21 mm	38	074452
V7512-22	22 mm	38	074469
V7512-23	23 mm	38	074476
V7512-24	24 mm	38	074483
V7512-27	27 mm	42	074490
V7512-30	30 mm	44	074506
V7512-32	32 mm	44	074513
V7512-36	36 mm	46	080477

6-point socket · long



VIGOR No.	Size	L mm	EAN 4047728+
V2579N	10 mm	77	058445
V2580N	11 mm	77	058452
V2581N	12 mm	77	058469
V2584N	13 mm	77	058483
V2585N	14 mm	77	058490
V2586N	15 mm	77	058506
V2587N	16 mm	77	058513
V2588N	17 mm	77	058520
V2589N	18 mm	77	058537
V2590N	19 mm	77	058544
V2591N	22 mm	77	058551

12-point socket · long

NEW



VIGOR No.	Size	EAN 4047728+
V7512L-10	10 mm	080750
V7512L-11	11 mm	080767
V7512L-12	12 mm	080774
V7512L-13	13 mm	080781
V7512L-14	14 mm	080798
V7512L-15	15 mm	080804
V7512L-16	16 mm	080811
V7512L-17	17 mm	080828
V7512L-18	18 mm	080835
V7512L-19	19 mm	080842
V7512L-22	22 mm	080859

Sockets



T-profile socket



VIGOR No.	Size	mm	EAN 4047728+
V2730	E10	38	027304
V2731	E11	38	027311
V2732	E12	38	027328
V2733	E14	38	027335
V2734	E16	38	027342
V2196	E18	38	021968
V2197	E20	38	021975
V2735	E22	38	027359
V2592N	E24	38	058568

T-Plus socket



VIGOR No.	Size	EAN 4047728+
V7920-EP18	E18+	078238
V7920-EP20	E20+	078245
V7920-EP22	E22+	078252
V7920-EP24	E24+	078269

Spark plug socket



VIGOR No.	Size	mm	EAN 4047728+
V2578N	16 mm	66	058438
V2582N	21 mm	66	058476

Socket with multi-purpose profile



VIGOR No.	Size	mm	EAN 4047728+
V1988	10 mm	38.1	019880
V1989	11 mm	38.1	019897
V1990	12 mm	38.1	019903
V1991	13 mm	38.1	019910
V1992	14 mm	38.1	019927
V1993	15 mm	38.1	019934
V1994	16 mm	38.1	019941
V1995	17 mm	38.1	019958
V1996	18 mm	38.1	019965

VIGOR No.	Size	mm	EAN 4047728+
V1997	19 mm	38.1	019972
V1998	20 mm	38.1	019989
V1999	21 mm	38.1	019996
V2000	22 mm	38.1	020008
V2001	24 mm	40	020015
V2002	27 mm	42	020022
V2003	30 mm	45	020039
V2004	32 mm	45	020046



Screwdriver socket for inside hexagon screws



VIGOR No.	Size	Length mm	EAN 4047728+
V2101	5 mm	55	021012
V2102	6 mm	55	021029
V2103	7 mm	55	021036
V2104	8 mm	55	021043
V2105	10 mm	55	021050

VIGOR No.	Size	Length mm	EAN 4047728+
V2106	12 mm	55	021067
V2107	14 mm	55	021074
V2069	17 mm	55	020695
V2070	19 mm	55	020701

Screwdriver socket for inside hexagon screws



VIGOR No.	Size	Length mm	EAN 4047728+
V2072	5 mm	100	020725
V2073	6 mm	100	020732
V2074	7 mm	100	020749
V2075	8 mm	100	020756

VIGOR No.	Size	Length mm	EAN 4047728+
V2076	10 mm	100	020763
V2077	11 mm	100	020770
V2078	12 mm	100	020787
V2079	13 mm	100	020794

Screwdriver socket for inside hexagon screws



VIGOR No.	Size	Length mm	EAN 4047728+
V2080	5 mm	140	020800
V2081	6 mm	140	020817
V2082	7 mm	140	020824
V2083	8 mm	140	020831
V2084	10 mm	140	020848
V2085	12 mm	140	020855
V2086	14 mm	140	020862

Screwdriver socket for inside hexagon screws



VIGOR No.	Size	Length mm	EAN 4047728+
V2087	5 mm	200	020879
V2088	6 mm	200	020886
V2089	7 mm	200	020893
V2090	8 mm	200	020909
V2091	10 mm	200	020916
V2092	12 mm	200	020923

Screwdriver socket for screws with internal serration (XZN)



VIGOR No.	Size	Length mm	EAN 4047728+
V2094	M5	55	020947
V2095	M6	55	020954
V2096	M8	55	020961
V2097	M9	55	020978

VIGOR No.	Size	Length mm	EAN 4047728+
V2098	M10	55	020985
V2099	M12	55	020992
V2065	M14	55	020657
V2100	M16	55	021005

Sockets



Screwdriver socket for screws with internal serration (XZN)



VIGOR No.	Size	Length mm	EAN 4047728+
V2066	M5	100	020664
V2068	M6	100	020688
V2067	M8	100	020671
V2113	M9	100	021135
V2059	M10	100	020596
V2060	M12	100	020602
V2121	M14	100	021210

Screwdriver socket for screws with internal serration (XZN)



VIGOR No.	Size	Length mm	EAN 4047728+
V2122	M5	140	021227
V2124	M6	140	021241
V2123	M8	140	021234
V2126	M9	140	021265
V2128	M10	140	021289
V2129	M12	140	021296
V2132	M14	140	021326

Screwdriver socket for screws with internal serration (XZN)



VIGOR No.	Size	Length mm	EAN 4047728+
V2133	M8	200	021333
V2134	M10	200	021340
V2135	M12	200	021357
V2137	M14	200	021371

T screwdriver socket



VIGOR No.	Size	Length mm	EAN 4047728+
V2151	T20	55	021517
V2152	T25	55	021524
V2153	T27	55	021531
V2154	T30	55	021548
V2155	T40	55	021555

VIGOR No.	Size	Length mm	EAN 4047728+
V2156	T45	55	021562
V2157	T50	55	021579
V2158	T55	55	021586
V2159	T60	55	021593
V2160	T70	55	021609

T screwdriver socket



VIGOR No.	Size	Length mm	EAN 4047728+
V2161	T20	100	021616
V2162	T25	100	021623
V2163	T27	100	021630
V2165	T30	100	021654
V2167	T40	100	021678

VIGOR No.	Size	Length mm	EAN 4047728+
V2168	T45	100	021685
V2169	T50	100	021692
V2170	T55	100	021708
V2171	T60	100	021715
V2172	T70	100	021722

T screwdriver socket



VIGOR No.	Size	← L → mm	EAN 4047728+
V2173	T40	140	021739
V2174	T45	140	021746
V2175	T50	140	021753
V2176	T55	140	021760
V2177	T60	140	021777
V2178	T70	140	021784

T screwdriver socket



VIGOR No.	Size	← L → mm	EAN 4047728+
V2179	T40	200	021791
V2180	T45	200	021807
V2181	T50	200	021814
V2182	T55	200	021821
V2183	T60	200	021838
V2184	T70	200	021845

T-Plus screwdriver socket



VIGOR No.	Size	EAN 4047728+
V7055-IP40	T40+	078344
V7055-IP45	T45+	078351
V7055-IP50	T50+	078368
V7055-IP55	T55+	078375
V7055-IP60	T60+	078382

TR-Plus screwdriver socket



VIGOR No.	Size	EAN 4047728+
V7055-IPR40	T40+H	078467
V7055-IPR45	T45+H	078474
V7055-IPR50	T50+H	078481
V7055-IPR55	T55+H	078498
V7055-IPR60	T60+H	078504

T screwdriver socket



VIGOR No.	Size	← L → mm	EAN 4047728+
V7055-T40H	T40H	55	078511
V7055-T45H	T45H	55	078528
V7055-T50H	T50H	55	078535
V7055-T55H	T55H	55	078542
V7055-T60H	T60H	55	078559

Sockets



RIBE screwdriver socket



VIGOR No.	Size	L mm	EAN 4047728+
V2202	M5	55	022026
V2203	M6	55	022033
V2204	M7	55	022040
V2205	M8	55	022057
V2206	M9	55	022064

VIGOR No.	Size	L mm	EAN 4047728+
V2207	M10	55	022071
V2208	M12	55	022088
V2209	M13	55	022095
V2210	M14	55	022101

RIBE screwdriver socket



VIGOR No.	Size	L mm	EAN 4047728+
V2211	M5	100	022118
V2212	M6	100	022125
V2213	M7	100	022132
V2214	M8	100	022149
V2215	M9	100	022156

VIGOR No.	Size	L mm	EAN 4047728+
V2216	M10	100	022163
V2217	M12	100	022170
V2218	M13	100	022187
V2219	M14	100	022194

RIBE screwdriver socket



VIGOR No.	Size	L mm	EAN 4047728+
V2220	M8	140	022200
V2221	M9	140	022217
V2222	M10	140	022224
V2223	M10.3	140	022231
V2224	M12	140	022248
V2225	M13	140	022255
V2226	M14	140	022262

RIBE screwdriver socket



VIGOR No.	Size	L mm	EAN 4047728+
V2227	M8	200	022279
V2228	M9	200	022286
V2229	M10	200	022293
V2230	M10.3	200	022309
V2231	M12	200	022316
V2232	M13	200	022323
V2233	M14	200	022330

T ball-head screwdriver socket



VIGOR No.	Size	L mm	EAN 4047728+
V7055-T20	T20	55	075954
V7055-T25	T25	55	075961
V7055-T27	T27	55	075978
V7055-T30	T30	55	075985

VIGOR No.	Size	L mm	EAN 4047728+
V7055-T40	T40	55	075992
V7055-T45	T45	55	076005
V7055-T50	T50	55	076012
V7055-T55	T55	55	076029



T ball-head screwdriver socket



VIGOR No.	Size	L mm	EAN 4047728+
V7075-T60	T60	75	076036
V7075-T70	T70	75	076043

T ball-head screwdriver socket



VIGOR No.	Size	L mm	EAN 4047728+
V7100-T20	T20	100	076050
V7100-T25	T25	100	076067
V7100-T27	T27	100	076074
V7100-T30	T30	100	076081
V7100-T40	T40	100	076098
V7100-T45	T45	100	076104
V7100-T50	T50	100	076234
V7100-T55	T55	100	076241
V7100-T60	T60	100	076258
V7100-T70	T70	100	076265

T ball-head screwdriver socket



VIGOR No.	Size	L mm	EAN 4047728+
V7140-T40	T40	140	076272
V7140-T45	T45	140	076289
V7140-T50	T50	140	076296
V7140-T55	T55	140	076302
V7140-T60	T60	140	076319
V7140-T70	T70	140	076326

T ball-head screwdriver socket



VIGOR No.	Size	L mm	EAN 4047728+
V7200-T40	T40	200	076333
V7200-T45	T45	200	076340
V7200-T50	T50	200	076357
V7200-T55	T55	200	076364
V7200-T60	T60	200	076371
V7200-T70	T70	200	076388

Screwdriver socket for inside hexagon screws



VIGOR No.	Size	L mm	EAN 4047728+
V7055-H5	5 mm	55	076395
V7055-H6	6 mm	55	076401
V7055-H7	7 mm	55	076418
V7055-H8	8 mm	55	076425
V7055-H10	10 mm	55	076432
V7055-H12	12 mm	55	076449
V7055-H14	14 mm	55	076456

Sockets



Screwdriver socket for inside hexagon screws



VIGOR No.	Size	L mm	EAN 4047728+
V7075-H17	17 mm	75	076463
V7075-H19	19 mm	75	076470

Screwdriver socket for inside hexagon screws



VIGOR No.	Size	L mm	EAN 4047728+
V7100-H5	5 mm	100	076487
V7100-H6	6 mm	100	076517
V7100-H7	7 mm	100	076524
V7100-H8	8 mm	100	076531

VIGOR No.	Size	L mm	EAN 4047728+
V7100-H10	10 mm	100	076548
V7100-H11	11 mm	100	076555
V7100-H12	12 mm	100	076562
V7100-H13	13 mm	100	076579

Screwdriver socket for inside hexagon screws



VIGOR No.	Size	L mm	EAN 4047728+
V7140-H5	5 mm	140	076586
V7140-H6	6 mm	140	076593
V7140-H7	7 mm	140	076609
V7140-H8	8 mm	140	076616
V7140-H10	10 mm	140	076623
V7140-H12	12 mm	140	076630
V7140-H14	14 mm	140	076647

Screwdriver socket for inside hexagon screws



VIGOR No.	Size	L mm	EAN 4047728+
V7200-H5	5 mm	200	076654
V7200-H6	6 mm	200	076661
V7200-H7	7 mm	200	076678
V7200-H8	8 mm	200	076685
V7200-H10	10 mm	200	076692
V7200-H12	12 mm	200	076708

Universal joint

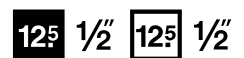

VIGOR No.	L mm	EAN 4047728+
V2575N	75	058407



Extension

12⁵/₈" **12⁵/₈"**

VIGOR No.	mm	EAN 4047728+
V2576N	125	058414
V2577N	250	058421
V4398N	750	058896

Wobble extension

- Operating screw connections in confined spaces and working in areas with restricted access
- Spherical, tapered outside square

12⁵/₈" **12⁵/₈"**

VIGOR No.	mm	EAN 4047728+
V4317	50	043175
V4318	75	043182
V4319	250	043199

Adapter



10 3/8" **12⁵/₈"**

VIGOR No.	mm	EAN 4047728+
V2109	36	021098

Adapter



20 3/4" **12⁵/₈"**

VIGOR No.	mm	EAN 4047728+
V2110	46	021104

Bit adapter



8 5/16" **12⁵/₈"**

VIGOR No.	mm	EAN 4047728+
V2647N	37	058711

Impact socket · short

- Surface: phosphatized
- For impact operation

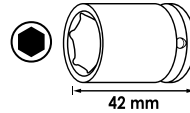
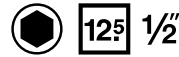

VIGOR No.	Size	EAN 4047728+
V5550S-10	10 mm	056175
V5550S-11	11 mm	056182
V5550S-12	12 mm	056199
V5550S-13	13 mm	056205
V5550S-14	14 mm	056212
V5550S-15	15 mm	056229
V5550S-16	16 mm	056236
V5550S-17	17 mm	056243
V5550S-18	18 mm	056250
V5550S-19	19 mm	056267
V5550S-21	21 mm	056274
V5550S-22	22 mm	056281
V5550S-24	24 mm	056298

Impact socket · long

- Surface: phosphatized
- For impact operation

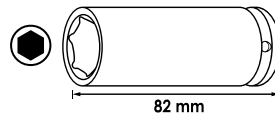

VIGOR No.	Size	EAN 4047728+
V5550L-10	10 mm	056045
V5550L-11	11 mm	056052
V5550L-12	12 mm	056069
V5550L-13	13 mm	056076
V5550L-14	14 mm	056083
V5550L-15	15 mm	056090
V5550L-16	16 mm	056106
V5550L-17	17 mm	056113
V5550L-18	18 mm	056120
V5550L-19	19 mm	056137
V5550L-21	21 mm	056144
V5550L-22	22 mm	056151
V5550L-24	24 mm	056168

Extractor socket with spiral profile

- Operation of nuts with damaged heads (special profile)
- For manual operation



VIGOR No.	Size	L mm	EAN 4047728+
V2404N-6	6 mm	50	082327
V2404N-7	7 mm	50	082334
V2404N-8	8 mm	50	082341
V2404N-9	9 mm	50	082358
V2404N-10	10 mm	50	082365
V2404N-11	11 mm	50	082372
V2404N-12	12 mm	50	082389
V2404N-13	13 mm	50	082396
V2404N-14	14 mm	50	082402
V2404N-15	15 mm	50	082419

VIGOR No.	Size	L mm	EAN 4047728+
V2404N-16	16 mm	50	082426
V2404N-17	17 mm	50	082433
V2404N-19	19 mm	50	082440
V2404N-21	21 mm	50	082457
V2404N-22	22 mm	50	082464
V2404N-24	24 mm	50	082471
V2404N-27	27 mm	50	082488
V2404N-30	30 mm	50	082495
V2404N-32	32 mm	50	082501

Impact screwdriver socket

- Surface: phosphatized
- For impact operation



VIGOR No.	Size	L mm	EAN 4047728+
V7017-T30	T30	78	066389
V7017-T40	T40	78	066396
V7017-T45	T45	78	066402
V7017-T50	T50	78	066419
V7017-T55	T55	78	066426
V7017-T60	T60	78	066242
V7017-T70	T70	78	066259
V7017-T80	T80	78	066266



Impact screwdriver socket

- Surface: phosphatized
- For impact operation



VIGOR No.	Size	L mm	EAN 4047728+
V7018-M5	M5	78	066273
V7018-M6	M6	78	066280
V7018-M8	M8	78	066297
V7018-M10	M10	78	066303
V7018-M12	M12	78	066518
V7018-M14	M14	78	066525
V7018-M16	M16	78	066532
V7018-M18	M18	78	066549

Impact screwdriver socket

- Surface: phosphatized
- For impact operation



VIGOR No.	Size	L mm	EAN 4047728+
V7019-H5	5 mm	78	066556
V7019-H6	6 mm	78	066563
V7019-H8	8 mm	78	066570
V7019-H10	10 mm	78	066587
V7019-H12	12 mm	78	066594
V7019-H14	14 mm	78	066600
V7019-H17	17 mm	78	066617
V7019-H19	19 mm	78	066624

Impact socket (12-point) · short

- Extra thin-walled socket for cardan shaft screw connections in the wheel hub
- Borehole for locking pin or safety spring and groove for o-ring
- Adjusted to given spaces in the wheel hub
- For e.g.:
 - VW Touareg model year 2003 →
 - AUDI A4 model year 2001 → · A6 model year 2005 → · A8 model year 2003 → · Q7 model year 2007 →
 - Other models
- For impact operation

● 32 mm

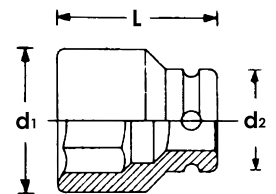

VIGOR No.	d1 mm	d2 mm	Size	L mm	EAN 4047728+
V4477	44.4	30	32 mm	50	044776

Impact socket (12-point) · short

- Extra thin-walled socket for cardan shaft screw connections in the wheel hub
- Borehole for locking pin or safety spring and groove for o-ring
- Adjusted to given spaces in the wheel hub
- For e.g.: OPEL/VAUXHALL Corsa D model year 2006 →, Adam model year 2012 →, Mokka model year 2012 → · CHEVROLET/GMC Trax model year 2013 →
- Other models
- Also for BMW · SEAT and VW vehicles
- For impact operation

● 36 mm

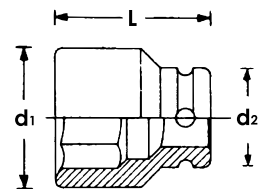

VIGOR No.	d1 mm	d2 mm	Size	L mm	EAN 4047728+
V4478	46.9	30	36 mm	50	044783

Sockets



V2318N, EAN 4047728**059299**

Socket set

- 24 teeth
- 15° Opening angle
- For manual operation

20 3/4"

21

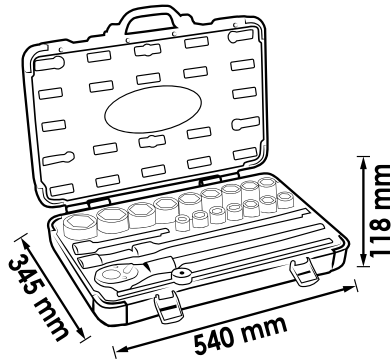

Quantity	Size	Design	Size
16 x	20 3/4"		19 · 21 · 22 · 23 · 24 · 26 · 27 · 28 · 30 · 32 · 34 · 36 · 38 · 41 · 46 · 50 mm
1 x	-		500 mm
1 x	20 3/4"		100 mm
1 x	20 3/4"		200 mm
1 x	20 3/4"		400 mm
1 x	-		450 mm



Reversible ratchet

- 24 teeth
- 15° Opening angle
- For manual operation

20 3/4"



VIGOR No.	Length mm	EAN
V2319N	500	4047728+ 059282

Sliding T-handle

- For manual operation

20 3/4"



VIGOR No.	Length mm	EAN
V2322N	450	4047728+ 057158

Adapter

12 5/8" 20 3/4"



VIGOR No.	Length mm	EAN
V2111	50	4047728+ 021111



Extension

20 3/4" 20 3/4"



VIGOR No.	mm	EAN 4047728+
V2320N	100	057561
V2321N	200	057578
V2317N	400	057554

Socket

20 3/4"



VIGOR No.	Size	mm	EAN 4047728+
V2323N	19 mm	50	057165
V2324N	21 mm	50	057172
V2325N	22 mm	50	057189
V2326N	23 mm	50	057196
V2327N	24 mm	50	057202
V2328N	26 mm	50	057615
V2329N	27 mm	52	057622
V2256N	28 mm	52	057059
V2924N	30 mm	54	057639
V2331N	32 mm	56	057646
V2332N	34 mm	58	057653
V2333N	36 mm	58	057677
V2334N	38 mm	60	057684
V2337N	41 mm	64	057721
V2336N	46 mm	68	057707
V2335N	50 mm	68	057691

V5024, EAN 4047728050241

Impact socket set

- Extra thin-walled sockets for drive shaft screw joints in the wheel hub
- Adjusted to given spaces in the wheel hub
- Among others for:
 - Size 24: VW Touran model year 2006 →
 - Size 30: VW Passat C, Golf 4, Polo, New Beetle · AUDI TT · ŠKODA Octavia, Superb, Fabia
 - Size 32: VW Touareg model year 2003 →
 - SW 36: BMW 3-series · 5-series · 7-series · SEAT Ibiza · VW Polo, Golf Plus · OPEL Corsa D · Adam · Mokka · CHEVROLET Trax model year → 2013 · FIAT 500 · Grande Punto · Punto Evo model year → 2005 · FORD Ka · MERCEDES-BENZ S-Class · JAGUAR XJ40 · XJ181
- For impact operation

20 3/4" 4



VIGOR No.	d1 mm	d2 mm	Size	mm	EAN 4047728+
V5025	44.3	35	24 mm	44	050258
V5026	44.3	42	30 mm	50	050265
V5182	44.3	44.3	32 mm	50	051828
V5183	44.3	46.9	36 mm	50	051835

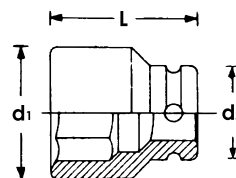

Sockets



V7212, EAN 4047728072120

Impact screwdriver socket set

- Common screw connections VAG vehicles, e.g. brake carriers, central drive shafts, shock absorbers or screwed wheel bearing units
- Surface: burnished, oiled
- For impact operation

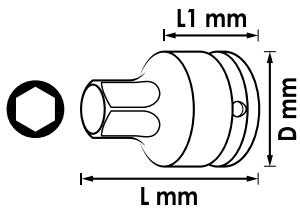
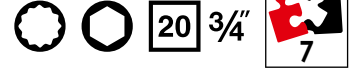

VIGOR No.	d2 mm	Size	L1 mm	L mm	EAN 4047728+
V7212-H14	44	14 mm	30	60	072168
V7212-H17	44	17 mm	30	60	072175
V7212-H19	44	19 mm	30	60	072182
V7212-H21	44	21 mm	30	60	072199
V7212-M14	44	M14	30	60	072137
V7212-M16	44	M16	30	60	072144
V7212-M18	44	M18	30	60	072151



V5505, EAN 4047728055055

Impact universal joint set

- Working in areas with restricted access, and for getting around obstructive edges
- Borehole for locking pin or safety spring and groove for o-ring
- For impact operation

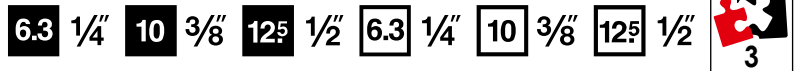

VIGOR No.	EAN 4047728+
V5505-1/4	055062
V5505-3/8	055079
V5505-1/2	055086



V1293, EAN 4047728012935







Adapter set

• For manual operation

6.3 1/4 10 3/8 12.5 1/2 20 3/4  6
6.3 1/4 10 3/8 12.5 1/2 20 3/4



Single parts from page 131



XX	■	■	Design	Size
1 x	6.3 1/4	10 3/8		26 mm
1 x	10 3/8	6.3 1/4		27 mm
1 x	10 3/8	12.5 1/2		36 mm
1 x	12.5 1/2	10 3/8		36 mm
1 x	12.5 1/2	20 3/4		46 mm
1 x	20 3/4	12.5 1/2		50 mm



V2687, EAN 4047728026871







T socket set

• For manual operation

 6.3 1/4 10 3/8 12.5 1/2  28



Single parts from page 127

XX	■	●	Design	Size
7 x	6.3 1/4			E4 · E5 · E6 · E7 · E8 · E10 · E11
12 x	10 3/8			E4 · E5 · E6 · E7 · E8 · E10 · E11 · E12 · E14 · E16 · E18 · E20
9 x	12.5 1/2			E10 · E11 · E12 · E14 · E16 · E18 · E20 · E22 · E24



Sockets



V1781, EAN 4047728**017817**

T socket set

• For manual operation

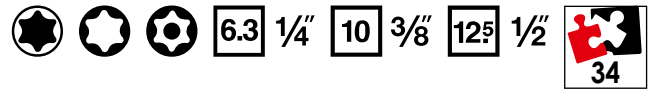

Single parts from page 127

XX	■	●	Design	Size
5 x	6.3 1/4	●	E4 · E5 · E6 · E7 · E8	
1 x	6.3 1/4	●	T27	
5 x	6.3 1/4	●	T9H · T10H · T15H · T25H · T30H	
4 x	10 3/8	●	E10 · E12 · E14 · E16	
4 x	10 3/8	●	T40 · T45 · T47 · T50	
2 x	10 3/8	●	T45H · T50H	
2 x	12.5 1/2	●	E18 · E20	
2 x	12.5 1/2	●	T55 · T60	
1 x	12.5 1/2	●	T55H	



V1706N, EAN 4047728**056465**

Socket set

• For manual operation

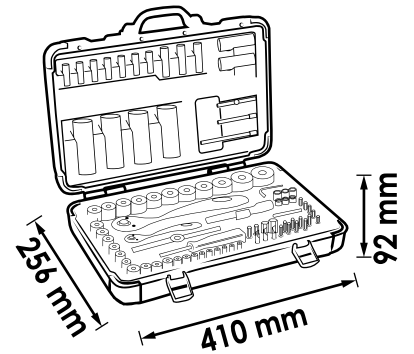

Single parts from page 124

XX	■	□	Design	Size
4 x	8 5/16	☼		T40 · T45 · T50 · T55
4 x	8 5/16	○		8 · 10 · 12 · 14 mm
2 x	8 5/16	+		PH3 · PH4
2 x	8 5/16	☼		PZ3 · PZ4
3 x	8 5/16	⊖		1.6x8 · 2x12 · 1.6x10 mm
1 x	-	○		2 mm
1 x	6.3 1/4	6.3 1/4		25 mm
1 x	12.5 1/2	8 5/16		37 mm
1 x	-	6.3 1/4		150 mm
1 x	6.3 1/4	6.3 1/4		110 mm
1 x	-	12.5 1/2		43.7 mm
4 x	6.3 1/4	○		3 · 4 · 5 · 6 mm
3 x	6.3 1/4	⊖		0.8x4 · 1x5.5 · 1.2x7 mm
2 x	6.3 1/4	+		PH1 · PH2
2 x	6.3 1/4	☼		PZ1 · PZ2

XX	■	□	Design	Size
5 x	6.3 1/4	☼		T10 · T15 · T20 · T25 · T30
18 x	12.5 1/2	○		10 · 11 · 12 · 13 · 14 · 15 · 16 · 17 · 18 · 19 · 20 · 21 · 22 · 23 · 24 · 27 · 30 · 32 mm
4 x	12.5 1/2	○		14 · 15 · 17 · 19 mm
13 x	6.3 1/4	○		4 · 4.5 · 5 · 5.5 · 6 · 7 · 8 · 9 · 10 · 11 · 12 · 13 · 14 mm
8 x	6.3 1/4	○		6 · 7 · 8 · 9 · 10 · 11 · 12 · 13 mm
1 x	-	6.3 1/4		150 mm
1 x	-	12.5 1/2		250 mm
1 x	6.3 1/4	6.3 1/4		40 mm
1 x	12.5 1/2	12.5 1/2		75 mm
1 x	6.3 1/4	6.3 1/4		50 mm
1 x	6.3 1/4	6.3 1/4		100 mm
1 x	6.3 1/4	6.3 1/4		145 mm
1 x	12.5 1/2	12.5 1/2		125 mm
1 x	12.5 1/2	12.5 1/2		250 mm
2 x	12.5 1/2	○		16 · 21 mm

Sockets



V2461N, EAN 4047728056472

Socket set

• For manual operation

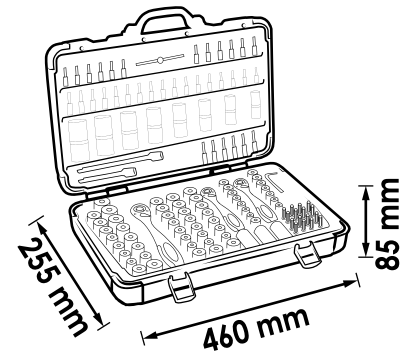
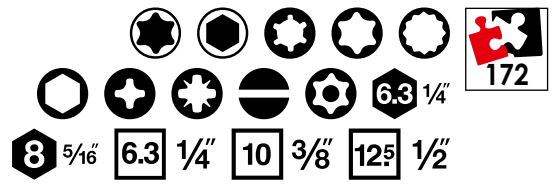

Single parts from page 124

XX	■	■	Design	Size
5 x	6.3 1/4	⊕		R5 · R6 · R7 · R8 · R9
3 x	6.3 1/4	⊕		T5 · T6 · T7
3 x	6.3 1/4	○		M5 · M6 · M8
9 x	6.3 1/4	⊕		T7H · T10H · T15H · T20H · T25H · T27H · T30H · T40H · T45H
6 x	8 5/16	⊕		T40 · T45 · T50 · T55 · T60 · T70
5 x	8 5/16	○		7 · 8 · 10 · 12 · 14 mm
2 x	8 5/16	⊕		PH3 · PH4
2 x	8 5/16	⊕		PZ3 · PZ4
3 x	8 5/16	⊖		1.6x8 · 1.6x10 · 2x12 mm
6 x	8 5/16	⊕		T40H · T45H · T50H · T55H · T60H · T70H
2 x	-	○		1.3 · 2 mm
1 x	6.3 1/4	6.3 1/4		25 mm
1 x	10 3/8	8 5/16		28 mm
1 x	12.5 1/2	8 5/16		37 mm
1 x	-	6.3 1/4		150 mm
1 x	6.3 1/4	6.3 1/4		110 mm
1 x	-	12.5 1/2		43.7 mm
4 x	6.3 1/4	○		3 · 4 · 5 · 6 mm
4 x	6.3 1/4	⊖		0.8x4 · 1x5.5 · 1.2x6.5 · 1.2x7 mm
3 x	6.3 1/4	⊕		PH0 · PH1 · PH2
3 x	6.3 1/4	⊕		PZ0 · PZ1 · PZ2
8 x	6.3 1/4	⊕		T8 · T9 · T10 · T15 · T20 · T25 · T27 · T30
7 x	6.3 1/4	⊕		T8H · T9H · T10H · T15H · T25H · T27H · T30H

XX	■	■	Design	Size
6 x	10 3/8	⊕		E10 · E11 · E12 · E14 · E16 · E18
6 x	10 3/8	○		10 · 11 · 12 · 13 · 14 · 15 mm
10 x	10 3/8	○		10 · 11 · 12 · 13 · 14 · 15 · 16 · 17 · 18 · 19 mm
17 x	12.5 1/2	○		10 · 11 · 12 · 13 · 14 · 15 · 16 · 17 · 18 · 19 · 20 · 21 · 22 · 24 · 27 · 30 · 32 mm
5 x	12.5 1/2	○		16 · 17 · 18 · 19 · 22 mm
2 x	12.5 1/2	⊕		E20 · E22
13 x	6.3 1/4	○		4 · 4.5 · 5 · 5.5 · 6 · 7 · 8 · 9 · 10 · 11 · 12 · 13 · 14 mm
7 x	6.3 1/4	○		4 · 5 · 6 · 7 · 8 · 9 · 10 mm
5 x	6.3 1/4	⊕		E4 · E5 · E6 · E7 · E8
1 x	-	6.3 1/4		150 mm
1 x	-	10 3/8		198 mm
1 x	-	12.5 1/2		250 mm
1 x	6.3 1/4	6.3 1/4		40 mm
1 x	10 3/8	10 3/8		50 mm
1 x	12.5 1/2	12.5 1/2		75 mm
1 x	6.3 1/4	6.3 1/4		50 mm
1 x	6.3 1/4	6.3 1/4		100 mm
1 x	10 3/8	10 3/8		125 mm
1 x	12.5 1/2	12.5 1/2		125 mm
1 x	12.5 1/2	12.5 1/2		250 mm
1 x	10 3/8	○		18 mm
2 x	12.5 1/2	○		16 · 21 mm

V3277N, EAN 4047728**056489**

Socket set

• For manual operation

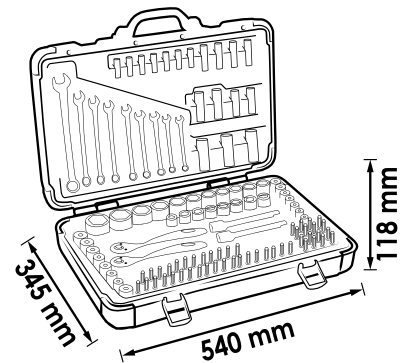

Single parts from page 124

XX	■	Design	Size
3 x	6.3 1/4	PH1 · PH2 · PH3	
3 x	6.3 1/4	PZ1 · PZ2 · PZ3	
3 x	6.3 1/4	1x5.5 · 1x6 · 1.6x8 mm	
5 x	6.3 1/4	3 · 4 · 5 · 6 · 7 mm	
6 x	6.3 1/4	T15H · T20H · T25H · T27H · T30H · T40H	
10 x	6.3 1/4	T10 · T15 · T20 · T25 · T27 · T30 · T40 · T45 · T8 · T9	
4 x	8 5/16	7 · 8 · 10 · 12 mm	
3 x	8 5/16	1.6x8 · 1.6x10 · 2x12 mm	
3 x	8 5/16	PH2 · PH3 · PH4	
3 x	8 5/16	PZ2 · PZ3 · PZ4	
5 x	8 5/16	T40 · T45 · T50 · T55 · T60	
5 x	8 5/16	T40H · T45H · T50H · T55H · T60H	
4 x	8 5/16	R10 · R11 · R12 · R13	
2 x	8 5/16	M10 · M12	
1 x	-	200 mm	
2 x	-	1.3 · 2 mm	
12 x	-	8 · 9 · 10 · 11 · 12 · 13 · 14 · 15 · 17 · 19 · 22 · 24 mm	
1 x	10 3/8	28 mm	
1 x	12.5 1/2	37 mm	
1 x	6.3 1/4	25 mm	
1 x	-	150 mm	
10 x	10 3/8	11 · 10 · 12 · 13 · 14 · 15 · 16 · 17 · 18 · 19 mm	

XX	■	Design	Size
6 x	10 3/8	E18 · E16 · E14 · E12 · E11 · E10	
6 x	10 3/8	10 · 11 · 12 · 13 · 14 · 15 mm	
14 x	12.5 1/2	13 · 14 · 15 · 16 · 17 · 18 · 19 · 20 · 21 · 22 · 24 · 27 · 30 · 32 mm	
3 x	12.5 1/2	E24 · E22 · E20	
5 x	12.5 1/2	16 · 17 · 18 · 19 · 22 mm	
13 x	6.3 1/4	4 · 4.5 · 5 · 5.5 · 6 · 7 · 8 · 9 · 10 · 11 · 12 · 13 · 14 mm	
5 x	6.3 1/4	E8 · E7 · E6 · E5 · E4	
7 x	6.3 1/4	4 · 5 · 6 · 7 · 8 · 9 · 10 mm	
1 x	-	6.3 1/4	150 mm
1 x	-	10 3/8	198 mm
1 x	-	12.5 1/2	250 mm
1 x	12.5 1/2	12.5 1/2	75 mm
1 x	10 3/8	10 3/8	50 mm
1 x	6.3 1/4	6.3 1/4	40 mm
1 x	12.5 1/2	12.5 1/2	125 mm
1 x	10 3/8	10 3/8	125 mm
1 x	6.3 1/4	6.3 1/4	100 mm
1 x	6.3 1/4	6.3 1/4	50 mm
1 x	12.5 1/2	12.5 1/2	250 mm
2 x	12.5 1/2	21 · 16 mm	
1 x	10 3/8	18 mm	

Sockets



V5461, EAN 4047728080323

Socket set

• For manual operation



NEW



12-point design



Single parts from page 126

XX	■	●	Design	Size
13 x	6.3 1/4	●		4 · 4.5 · 5 · 5.5 · 6 · 7 · 8 · 9 · 10 · 11 · 12 · 13 · 14 mm
11 x	10 3/8	●		9 · 10 · 11 · 12 · 13 · 14 · 15 · 16 · 17 · 18 · 19 mm
20 x	12.5 1/2	●		9 · 10 · 11 · 12 · 13 · 14 · 15 · 16 · 17 · 18 · 19 · 20 · 21 · 22 · 23 · 24 · 27 · 30 · 32 · 36 mm
11 x	6.3 1/4	●		4 · 5 · 5.5 · 6 · 7 · 8 · 9 · 10 · 11 · 12 · 13 mm
11 x	10 3/8	●		9 · 10 · 11 · 12 · 13 · 14 · 15 · 16 · 17 · 18 · 19 mm
11 x	12.5 1/2	●		10 · 11 · 12 · 13 · 14 · 15 · 16 · 17 · 18 · 19 · 22 mm
5 x	6.3 1/4	●		E4 · E5 · E6 · E7 · E8
6 x	10 3/8	●		E10 · E11 · E12 · E14 · E16 · E18
3 x	12.5 1/2	●		E20 · E22 · E24
4 x	6.3 1/4	○		3 · 4 · 5 · 6 mm
4 x	6.3 1/4	◐		0.8x4 · 1x5.5 · 1.2x6.5 · 1.2x7 mm
3 x	6.3 1/4	+		PH0 · PH1 · PH2
3 x	6.3 1/4	+		PZ0 · PZ1 · PZ2

XX	■	●	Design	Size
8 x	6.3 1/4	●		T8 · T9 · T10 · T15 · T20 · T25 · T27 · T30
8 x	6.3 1/4	●		T8H · T9H · T10H · T15H · T20H · T25H · T27H · T30H
1 x	6.3 1/4	6.3 1/4		40 mm
1 x	10 3/8	10 3/8		50 mm
1 x	12.5 1/2	12.5 1/2		75 mm
1 x	-	6.3 1/4		150 mm
1 x	6.3 1/4	6.3 1/4		110 mm
1 x	-	12.5 1/2		43.7 mm
1 x	6.3 1/4	6.3 1/4		50 mm
1 x	6.3 1/4	6.3 1/4		100 mm
1 x	10 3/8	10 3/8		125 mm
1 x	12.5 1/2	12.5 1/2		125 mm
1 x	12.5 1/2	12.5 1/2		250 mm

V4425N, EAN 4047728058919

Tool case · universal



Single parts from page 124

XX	■	●	Design	Size
12 x	-	●●		8 · 9 · 10 · 11 · 12 · 13 · 14 · 15 · 16 · 17 · 18 · 19 mm
4 x	-	●		0.6x3 · 0.8x4 · 1x5.5 · 1.2x6.5 mm
3 x	-	+		PH0 · PH1 · PH2
1 x	-	-		90 mm
1 x	-	-		160 mm
1 x	-	-		200 mm
1 x	-	-		300 g
1 x	6.3 1/4	6.3 1/4		100 mm
1 x	6.3 1/4	6.3 1/4		40 mm
11 x	6.3 1/4	●		4 · 5 · 5.5 · 6 · 7 · 8 · 9 · 10 · 11 · 12 · 13 mm
1 x	125 1/2	125 1/2		125 mm

XX	■	●	Design	Size
1 x	125 1/2	125 1/2		75 mm
16 x	125 1/2	●		10 · 11 · 12 · 13 · 14 · 15 · 16 · 17 · 19 · 20 · 21 · 22 · 24 · 27 · 30 · 32 mm
4 x	6.3 1/4	○		3 · 4 · 5 · 6 mm
3 x	6.3 1/4	●		0.8x4 · 1x5.5 · 1.2x6.5 mm
3 x	6.3 1/4	+		PH1 · PH2 · PH3
3 x	6.3 1/4	✳		PZ1 · PZ2 · PZ3
6 x	6.3 1/4	●		T10 · T15 · T20 · T25 · T30 · T40
1 x	-	6.3 1/4		150 mm
1 x	-	125 1/2		250 mm
9 x	-	○		1.5 · 2 · 2.5 · 3 · 4 · 5 · 6 · 8 · 10
9 x	-	●		T10 · T15 · T20 · T25 · T27 · T30 · T40 · T45 · T50

Universal tool cases



V2542, EAN 4047728**025423**

Tool case · universal

• Tool case including assortment



VIGOR No.	Designation	LxWxH mm	EAN 4047728+
V2400	Case · empty	510x410x140	024006
V2464	Soft foam insert · empty		024648

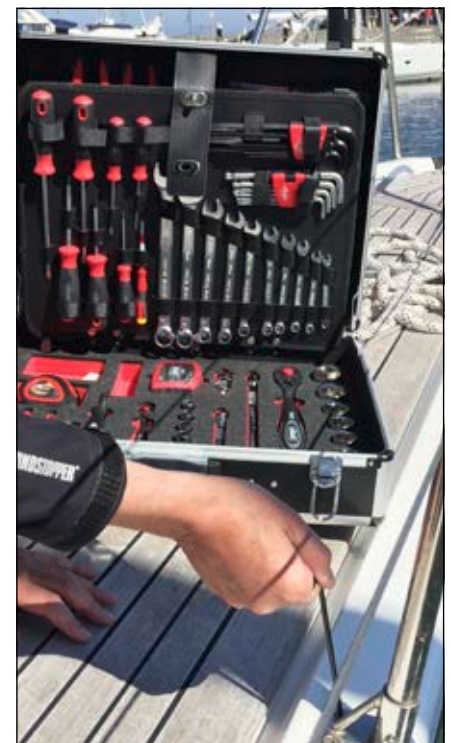

Double open-end wrench

- Secure hold with oily hands thanks to anti-slip surface
- Surface: matt chrome-plated
- DIN 3110

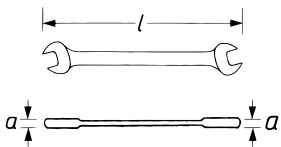

VIGOR No.	a mm	Size	l mm	EAN 4047728+
V1461N-6X7	3.4	6x7 mm	126	064903
V1461N-8X9	3.6	8x9 mm	142	064187
V1461N-10X11	4.5	10x11 mm	157	064200
V1461N-12X13	5.1	12x13 mm	170	064231
V1461N-14X15	5.4	14x15 mm	187	064262
V1461N-16X17	6	16x17 mm	202	064286
V1461N-18X19	7.3	18x19 mm	220	064309
V1461N-20X22	7.3	20x22 mm	232	064026
V1461N-21X23	7.5	21x23 mm	246	064033
V1461N-24X27	8.4	24x27 mm	265	064064
V1461N-25X28	8.5	25x28 mm	275	064071
V1461N-30X32	9.2	30x32 mm	298	064095

V1461N, EAN 4047728064934

Double open-end wrench set

- Secure hold with oily hands thanks to anti-slip surface
- Surface: matt chrome-plated
- DIN 3110



XX	Design	Size
12 x		6x7 · 8x9 · 10x11 · 12x13 · 14x15 · 16x17 · 18x19 · 20x22 · 21x23 · 24x27 · 25x28 · 30x32 mm

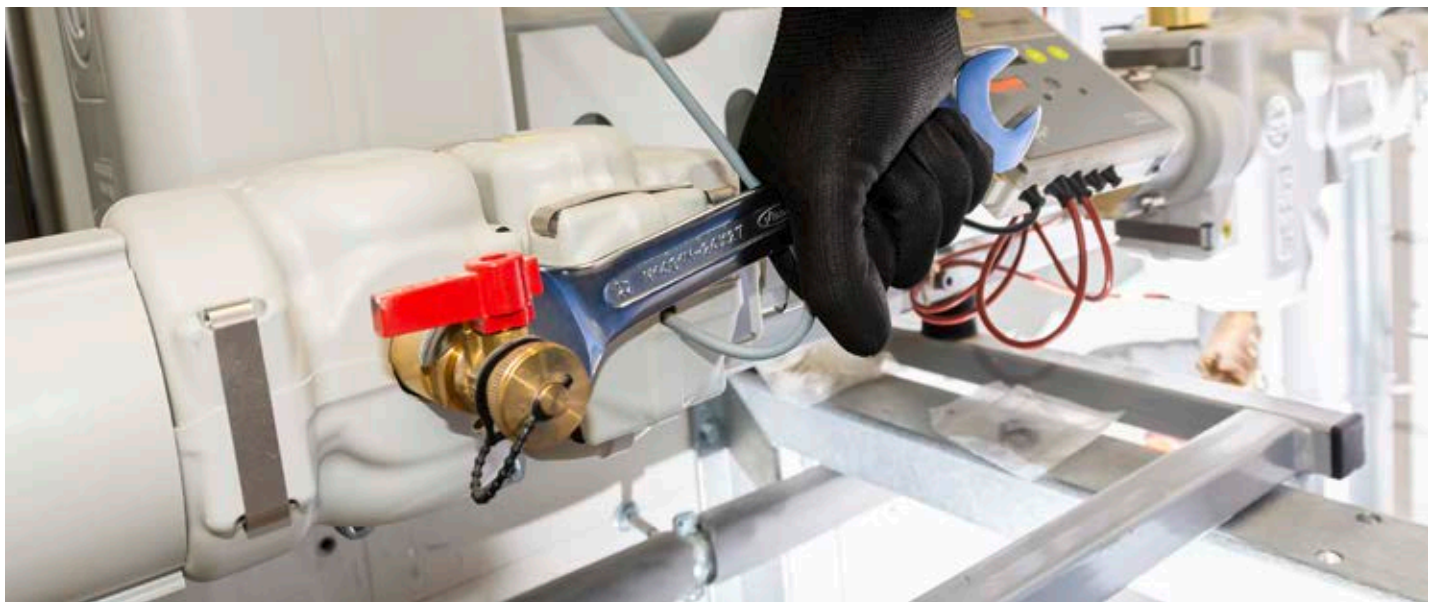

Wrenches



Combination wrench

- Long design
- 15° offset box-end wrench
- Secure hold with oily hands thanks to anti-slip surface
- Surface: matt chrome-plated
- DIN 3113 form A, ISO 7738

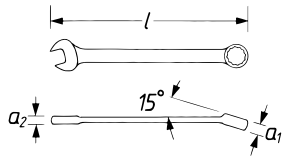

VIGOR No.	a1 mm	a2 mm	Size	L mm	EAN 4047728+
V4473N-6	4.8	3.4	6 mm	100	064439
V4473N-7	5.4	3.5	7 mm	110	064446
V4473N-8	5.5	3.8	8 mm	115	064453
V4473N-9	6	4	9 mm	125	064460
V4473N-10	6.3	4.5	10 mm	135	064477
V4473N-11	6.8	4.9	11 mm	145	064484
V4473N-12	7.2	5	12 mm	155	064491
V4473N-13	8.3	5.6	13 mm	165	064507
V4473N-14	8.5	5.7	14 mm	171	064514
V4473N-15	9.2	6.1	15 mm	185	064323
V4473N-16	9.3	6.5	16 mm	195	064569
V4473N-17	9.6	6.8	17 mm	210	064576
V4473N-18	10.1	7.2	18 mm	220	064583
V4473N-19	10.2	7.3	19 mm	230	064590
V4473N-20	10.8	7.4	20 mm	240	064606
V4473N-21	11.1	7.6	21 mm	245	064613
V4473N-22	11.7	7.9	22 mm	248	064408
V4473N-24	12.8	8.4	24 mm	270	064712
V4473N-27	13.9	9.1	27 mm	300	064736
V4473N-30	15.2	9.9	30 mm	330	064743
V4473N-32	15.9	10.2	32 mm	350	064750
V4473N-36	19.3	11.6	36 mm	400	064767

V4472N, EAN 4047728064958

Combination wrench set

- Long design
- 15° offset box-end wrench
- Secure hold with oily hands thanks to anti-slip surface
- Surface: matt chrome-plated
- DIN 3113 form A, ISO 7738



XX	Design	Size
15 x		6 · 7 · 8 · 9 · 10 · 11 · 12 · 13 · 14 · 15 · 16 · 17 · 18 · 19 · 22 mm

V4473N, EAN 4047728064965

Combination wrench set

- Long design
- 15° offset box-end wrench
- Secure hold with oily hands thanks to anti-slip surface
- Surface: matt chrome-plated
- DIN 3113 form A, ISO 7738



XX	Design	Size
22 x		6 · 7 · 8 · 9 · 10 · 11 · 12 · 13 · 14 · 15 · 16 · 17 · 18 · 19 · 20 · 21 · 22 · 24 · 27 · 30 · 32 · 36 mm



Double box-end wrench

- 15° offset
- Secure hold with oily hands thanks to anti-slip surface
- Surface: chrome-plated, polished
- DIN 838, ISO 10104

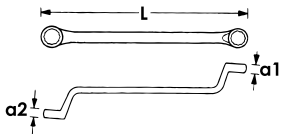

VIGOR No.	a1 mm	a2 mm	Size	L mm	EAN 4047728+
V1524N-6X7	5.8	5	6x7 mm	175	064774
V1524N-8X9	7.7	6.7	8x9 mm	185	064781
V1524N-10X11	8.4	7.4	10x11 mm	198	064798
V1524N-12X13	8.4	9.1	12x13 mm	215	064804
V1524N-14X15	10.4	9.5	14x15 mm	228	064811
V1524N-16X17	10.8	10	16x17 mm	246	064828
V1524N-18X19	12.1	10.8	18x19 mm	268	064835
V1524N-20X22	12.5	11.7	20x22 mm	292	064842
V1524N-21X23	13.2	12.2	21x23 mm	315	064859
V1524N-24X27	13.4	12.2	24x27 mm	328	064866
V1524N-25X28	14.9	13.9	25x28 mm	342	064873
V1524N-30X32	16	15.2	30x32 mm	370	064880

V1524N, EAN 4047728064910

Double box-end wrench set

- 15° offset
- Secure hold with oily hands thanks to anti-slip surface
- Surface: chrome-plated, polished
- DIN 838, ISO 10104



XX	Design	Size
12 x		6x7 · 8x9 · 10x11 · 12x13 · 14x15 · 16x17 · 18x19 · 20x22 · 21x23 · 24x27 · 25x28 · 30x32 mm

Ratcheting combination wrench · short

- 72 teeth
- 5° Opening angle

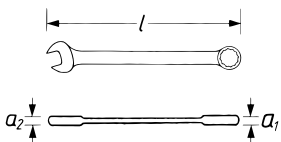

VIGOR No.	a1 mm	a2 mm	Size	L mm	EAN 4047728+
V2822	7.4	4.9	8 mm	89	028226
V2823	7.5	5.2	9 mm	93	028233
V2824	8.5	5.5	10 mm	97	028240
V2825	8.4	6.1	11 mm	102	028257
V2826	8.5	6.3	12 mm	106	028264
V2827	8.4	6.7	13 mm	110	028271
V2828	8.4	7	14 mm	114	028288
V2829	8.4	7.4	15 mm	120	028295
V2830	10	7.7	16 mm	122	028301
V2831	10	7.7	17 mm	126	028318
V2832	11.5	8.4	18 mm	131	028325
V2833	11.5	8.6	19 mm	136	028332

V2821, EAN 4047728028219

Ratcheting combination wrench set · short

- Delivery in tool roll
- 72 teeth
- 5° Opening angle



XX	Design	Size
12 x		8 · 9 · 10 · 11 · 12 · 13 · 14 · 15 · 16 · 17 · 18 · 19 mm

Wrenches



Ratcheting combination wrench · long

- Surface: chrome-plated, polished
- 72 teeth
- 5° Opening angle

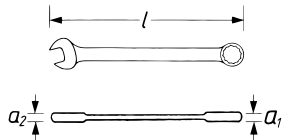

VIGOR No.	a1 mm	a mm	Size	l mm	EAN 4047728+
V3635	7.4	4.6	6 mm	135	036351
V3636	7.4	4.7	7 mm	144	036368
V1008	7.4	4.7	8 mm	140	010085
V1009	7.4	5.3	9 mm	151	010092
V1010	8.4	5.7	10 mm	160	010108
V1021	8.4	6.1	11 mm	165	010214
V1022	8.4	6.4	12 mm	170	010221
V1023	8.4	6.6	13 mm	177	010238
V1025	8.4	7.3	14 mm	192	010252
V1026	8.4	7.5	15 mm	200	010269
V1027	10	7.7	16 mm	210	010276
V1028	10	7.9	17 mm	225	010283
V1029	11.5	8.4	18 mm	235	010290
V1030	11.5	8.7	19 mm	245	010306
V4961	12.5	9	21 mm	275	049610
V4962	13.5	10	22 mm	285	049627
V4963	13.5	11	24 mm	296	049634
V4964	13.5	12	27 mm	340	049641
V4965	16	13	30 mm	369	049658
V4966	16	14	32 mm	395	049665

V1031, EAN 4047728010313

Ratcheting combination wrench set · long

- Tool roll
- Surface: chrome-plated, polished
- 72 teeth
- 5° Opening angle



XX	Design	Size
12 x		8 · 9 · 10 · 11 · 12 · 13 · 14 · 15 · 16 · 17 · 18 · 19 mm

V2820, EAN 4047728028202

Ratcheting combination wrench set · long

- Tool roll
- Surface: chrome-plated, polished
- 72 teeth
- 5° Opening angle



XX	Design	Size
5 x		8 · 10 · 13 · 17 · 19 mm



Double joint ratcheting combination wrench

- Ratchet head with double joint
- Box-end side with 12-point profile
- 72 teeth
- 5° Opening angle

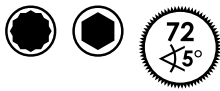

VIGOR No.	a1 mm	a2 mm	Size	L mm	EAN 4047728+
V6752-8	7.4	4.7	8 mm	163	067522
V6752-9	7.4	5.3	9 mm	168	067836
V6752-10	8.4	5.7	10 mm	178	067843
V6752-11	8.4	6.1	11 mm	186	067850
V6752-12	8.4	6.4	12 mm	196	067867
V6752-13	8.4	6.6	13 mm	206	067874
V6752-14	8.4	7.3	14 mm	217	067881
V6752-15	8.4	7.5	15 mm	228	067898
V6752-16	10	7.7	16 mm	245	067904
V6752-17	10	7.9	17 mm	259	068017
V6752-18	11.5	8.4	18 mm	273	068024
V6752-19	11.5	8.7	19 mm	285	068031

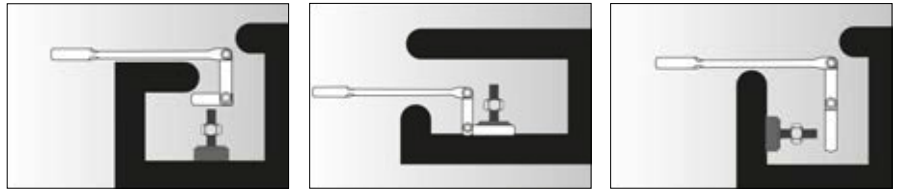
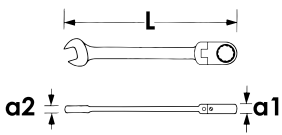

V6752/12, EAN 4047728068048

Double joint ratcheting combination wrench set

- Ratchet head with double joint
- Box-end side with 12-point profile
- In tool roll
- 72 teeth
- 5° Opening angle



XX	Design	Size
12 x		8 · 9 · 10 · 11 · 12 · 13 · 14 · 15 · 16 · 17 · 18 · 19 mm

V6752/5, EAN 4047728072113

Double joint ratcheting combination wrench set

- Ratchet head with double joint
- Box-end side with 12-point profile
- 72 teeth
- 5° Opening angle



XX	Design	Size
5 x		8 · 10 · 13 · 17 · 19 mm

Wrenches



Ratcheting combination wrench with hinge

- 72 teeth
- 5° Opening angle

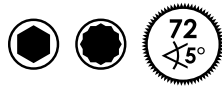

VIGOR No.	a1 mm	a2 mm	Size	L mm	EAN 4047728+
V2804	7.4	5	8 mm	143	028042
V2805	7.4	5.3	9 mm	150	028059
V2806	8.4	5.9	10 mm	158	028066
V2807	8.4	6.1	11 mm	165	028073
V2808	8.4	6.4	12 mm	170	028080
V2809	8.4	6.7	13 mm	182	028097
V2810	8.4	7.4	14 mm	190	028103
V2811	8.5	7.6	15 mm	200	028110
V2812	9.9	7.6	16 mm	215	028127
V2813	10	8	17 mm	228	028134
V2814	11.1	8.2	18 mm	241	028141
V2817	11.5	8.7	19 mm	250	028172

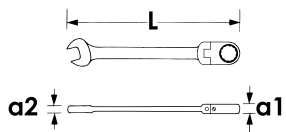

V2818, EAN 4047728028189

Ratcheting combination wrench set with hinge

- Tool roll
- Surface: chrome-plated, polished
- 72 teeth
- 5° Opening angle



	Design	Size
12 x		8 · 9 · 10 · 11 · 12 · 13 · 14 · 15 · 16 · 17 · 18 · 19 mm



V3607, EAN 4047728**036078**

Double ratcheting box-end wrench

- 72 teeth
- 5° Opening angle



Multi-purpose profile



10 mm

4 in 1

13 mm



8 mm

12 mm

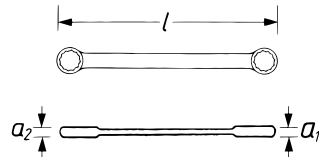

VIGOR No.	a1 mm	a2 mm	Size	l mm	EAN 4047728+
V3607	12.5	14.5	8x12 · 10x13	220	036078



V2705, EAN 4047728**027052**

Double ratcheting box-end wrench

- 72 teeth
- 5° Opening angle



12-point



17 mm

4 in 1

19 mm

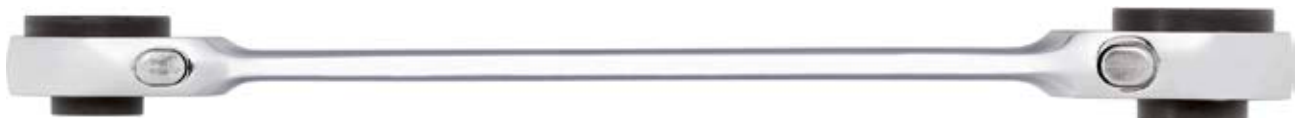

10 mm

13 mm

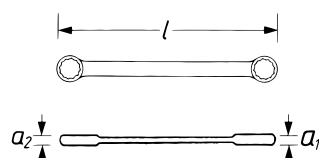

VIGOR No.	a1 mm	a2 mm	Size	l mm	EAN 4047728+
V2705	20	17	10x13 · 17x19	220	027052

Wrenches



V6611/4, EAN 4047728073561

Double ratcheting box-end wrench set

- Tool roll
- Surface: bright chrome-plated
- 72 teeth
- 5° Opening angle



XX		Design	Size
1 x			E6, E8
1 x			E10, E12
1 x			E14, E18
1 x			E20, E24



Adjustable wrench

- One-hand wrench size adjustment using the adjustable wheel on the wrench head
- Head set angled at 15°
- Easily legible mm scale on the wrench head



mm scale on the wrench head



Hanging hole



VIGOR No.	L mm	sb mm	EAN 4047728+
V6048	150	24	069625
V6049	250	33	069618



V1208, EAN 4047728012089

Screwdriver · short

• 5.5x38 mm



V1209, EAN 4047728012096

Screwdriver · short

• PH 2x38 mm



Screwdriver for slotted screws

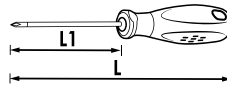

VIGOR No.	Size	L1 mm	mm	EAN 4047728+
V1698	0.6x3 mm	75	156	016988
V1699	0.8x4 mm	80	161	016995
V1700	1x5.5 mm	125	231	017008
V1701	1.2x6.5 mm	150	256	017015
V3613	1.6x8 mm	150	266	036139
V3609	1.6x10 mm	175	291	036092

Phillips-Recess screwdriver

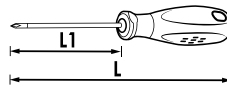

VIGOR No.	Size	L1 mm	mm	EAN 4047728+
V1702	PH0	75	156	017022
V1703	PH1	80	186	017039
V1704	PH2	100	206	017046
V3610	PH3	150	266	036108

Screwdriver for slotted screws with impact cap

• Manufactured according to DIN/ISO

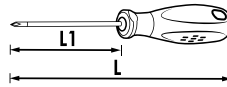

VIGOR No.	Size	L1 mm	mm	EAN 4047728+
V3597	0.6x3.5 mm	75	157	035972
V3598	1x4.5 mm	100	182	035989
V3599	1x5.5 mm	100	207	035996
V3600	1.2x6.5 mm	125	232	036009
V5042	1.6x8 mm	150	267	050425
V5043	1.6x10 mm	175	297	050432
V5044	2x12 mm	200	317	050449

Phillips-recess screwdriver with impact cap

• Manufactured according to DIN/ISO

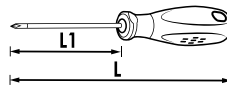

VIGOR No.	Size	L1 mm	mm	EAN 4047728+
V3601	PH1	182	75	036016
V3602	PH2	207	100	036023
V4667	PH3	200	315	046671

Screwdrivers and bits



V4655, EAN 4047728**046558**

Screwdriver set

• Manufactured according to DIN/ISO



XX		Design	Size
1 x	⊖		1x5.5 mm
5 x	⊖		0.6x3 · 0.8x4 · 1x5.5 · 1.6x8 · 1.6x10 mm
1 x	⊕		PH2
4 x	⊕		PH0 · PH1 · PH2 · PH3



V1637, EAN 4047728**016377**

Screwdriver set

• Manufactured according to DIN/ISO



XX		Design	Size
4 x	⊖		0.6x3 · 0.8x4 · 1x5.5 · 1.2x6.5 mm
3 x	⊕		PH0 · PH1 · PH2



V3562, EAN 4047728**035620**

Screwdriver set with impact cap

• Manufactured according to DIN/ISO

With impact cap



6-point



XX		Design	Size
4 x	⊖		0.6x3.5 · 1x4.5 · 1x5.5 · 1.2x6.5 mm
2 x	⊕		PH1 · PH2



V4432/6, EAN 4047728073868

Screwdriver set · extra long

• Working in areas with restricted access

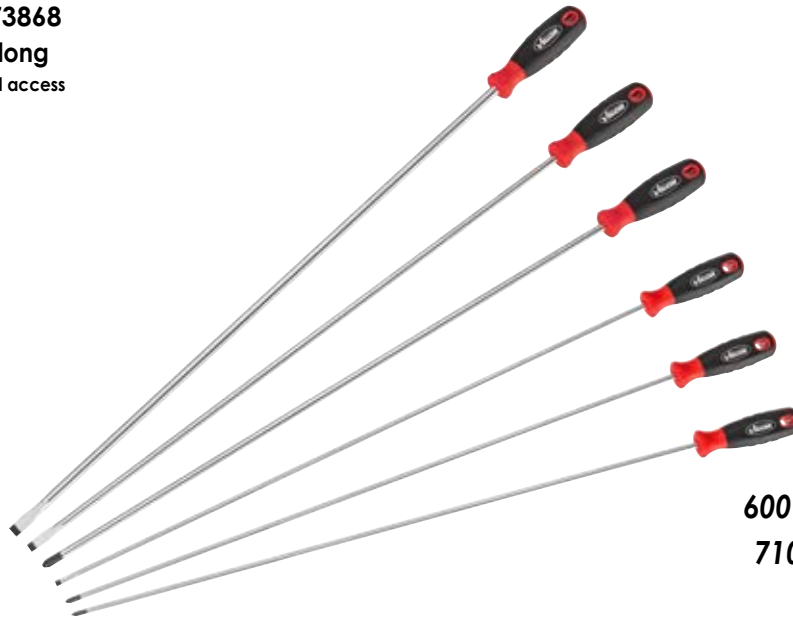

600 mm blade length
710 mm total length

VIGOR No.	Designation	Design		Size	mm	EAN 4047728+
V4436	Screwdriver for slotted screws · extra long			1.2x6 mm	600	073905
V4437	Screwdriver for slotted screws · extra long			1.6x8 mm	600	073912
V4438	Screwdriver for slotted screws · extra long			1.6x10 mm	600	073929
V4433	Phillips-Recess screwdriver · extra long			PH1	600	073875
V4434	Phillips-Recess screwdriver · extra long			PH2	600	073882
V4435	Phillips-Recess screwdriver · extra long			PH3	600	073899



V7124, EAN 4047728071246

Impact screwdriver set

- Operation of severely corroded screw connections, e.g. centring screws on brake discs
- A hammer strike actuates a quarter turn in release direction at the screwdriver output
- Switching modes by turning the control dial in 2 steps: standard mode and impact function



VIGOR No.	Designation	Design		Size	mm	EAN 4047728+
V7124-PH1	Impact screwdriver			PH1	160	071253
V7124-PH2	Impact screwdriver			PH2	185	071260
V7124-PH3	Impact screwdriver			PH3	210	071277
V7124-PZ1	Impact screwdriver			PZ1	185	071284
V7124-PZ2	Impact screwdriver			PZ2	185	071291
V7124-T20	Impact screwdriver			T20	160	071307
V7124-T25	Impact screwdriver			T25	185	071413
V7124-T30	Impact screwdriver			T30	210	071420



Screwdrivers and bits



T screwdriver

• Manufactured according to DIN/ISO

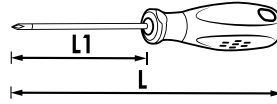

VIGOR No.	Size	L1 mm	mm	EAN 4047728+
V4419	T6	74	154	044196
V4420	T7	74	154	044202
V4421	T8	74	154	044219
V4422	T9	74	154	044226
V3367	T10	100	206	033671
V3368	T15	100	206	033688
V3369	T20	100	206	033695
V3370	T25	100	206	033701
V3391	T27	100	206	033916
V3392	T30	100	206	033923
V3393	T40	100	206	033930

V4418, EAN 4047728044189

T screwdriver set

• Manufactured according to DIN/ISO



XX	Design	Size
4 x		T6 · T7 · T8 · T9

V3366, EAN 4047728033664

T screwdriver set

• Manufactured according to DIN/ISO



XX	Design	Size
7 x		T10 · T15 · T20 · T25 · T27 · T30 · T40



Screwdriver, flexible

- Hose clamps on coolant hoses
- Working even in confined areas that cannot be reached with a conventional screwdriver
- Design with double spiral spring including plastic coating

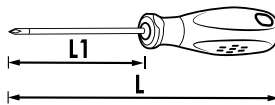

VIGOR No.	Size	L mm	EAN 4047728+
V4664	6 mm	300	046640
V4665	7 mm	300	046657
V4666	8 mm	300	046664

V5661, EAN 4047728056618

Screwdriver set · flexible

- Hose clamps on coolant hoses
- Working even in confined areas that cannot be reached with a conventional screwdriver
- Design with double spiral spring including plastic coating



XX	Design	Size
3 x		6 · 7 · 8 mm

V5485N, EAN 4047728060714

Screwdriver set · extra long · flexible

- Working in areas with restricted access
- Extra long, length: 500 mm
- Universal 6.3 mm (1/4") screwdriver bit socket
- Universal 6.3 mm (1/4") square
- 7 mm 6-point output



XX	Design	Size
6 x		T10 · T15 · T20 · T25 · T27 · T30
2 x		PH1 · PH2
2 x		1 x 5.5 · 1.2 x 6.5 mm
1 x		500 mm
1 x		500 mm
1 x		7 mm
5 x		5 · 6 · 7 · 8 · 10 mm

Screwdrivers and bits



V5601, EAN 4047728056014

Offset screwdriver set

- In clip
- Long design
- Ball-head
- Contents: 1.5 · 2 · 2.5 · 3 · 4 · 5 · 6 · 7 · 8 · 10 mm



Size 7 mm included



V4942, EAN 4047728049429

Offset screwdriver set

- In clip
- Long design
- Ball-head
- Contents: 1.5 · 2 · 2.5 · 3 · 4 · 5 · 6 · 8 · 10 mm



V4708, EAN 4047728047081

T offset screwdriver set

- In clip
- Long design
- Ball-head
- Contents: T10 · T15 · T20 · T25 · T27 · T30 · T40 · T45 · T50



V4303, EAN 4047728**043038**

Electronic screwdriver set

- Rotating head section and spinning area
- Four screwdrivers for slotted screws 1.6 · 2 · 2.4 · 3 mm
- Two screwdrivers for Phillips-Recess screws PH00 · PH0
- In plastic box



XX		Design	Size
4 x	⊖		1.6 · 2 · 2.4 · 3
2 x	⊕		PH0 · PH00

V3427N, EAN 4047728**058865**

Bit screwdriver

- For manual operation



6.3 1/4"



Hex-nut driver

- Surface: chrome-plated



VIGOR No.	Size	L1 mm	EAN 4047728+
V4200	6 mm	150	042000
V4221	7 mm	150	042215
V4222	8 mm	150	042222
V4223	10 mm	150	042239
V4224	12 mm	150	042246
V4225	13 mm	150	042253

V4199, EAN 4047728**041997**

Hex nut-driver set

- Surface: chrome-plated



XX		Design	Size
6 x	⊕		6 · 7 · 8 · 10 · 12 · 13 mm

Screwdrivers and bits



Hexagon T-handle screwdriver



VIGOR No.	Size	L1 mm	L mm	EAN 4047728+
V2489	2 mm	100	160	024891
V2486	2.5 mm	100	160	024860
V2507	3 mm	100	160	025072
V2506	4 mm	100	160	025065
V2505	5 mm	100	160	025058
V2504	6 mm	132	217	025041
V2503	8 mm	132	217	025034
V2502	10 mm	132	217	025027

V1409, EAN 4047728014090

6-point T-handle screwdriver set

• Including holder



Included



XX	Design	Size
8 x		2 · 2.5 · 3 · 4 · 5 · 6 · 8 · 10 mm

T-handle screwdriver



VIGOR No.	Size	L1 mm	L mm	EAN 4047728+
V2498	T9	100	160	024983
V2497	T10	100	160	024976
V2501	T15	100	160	025010
V2490	T20	100	160	024907
V2485	T25	100	160	024853
V2484	T27	132	217	024846
V2483	T30	132	217	024839
V2482	T40	132	217	024822

V1410, EAN 4047728014106

T-handle screwdriver set



Included



XX	Design	Size
8 x		T9 · T10 · T15 · T20 · T25 · T27 · T30 · T40



V7601-150, EAN 4047728**079433**

Bit holder with magnetic ring · long

- Strong magnetic ring to secure screws
- Screwdriver bit can be recessed into the holder to create a contact surface for the screw head
- Ideal for hard-to-reach places

6.3 1/4" 6.3 1/4"

NEW



VIGOR No.	d1 mm	L mm	EAN 4047728+
V7601-150	15.5	150	079433
V7601-250	15.5	250	079426



Screwdrivers and bits



V7600, EAN 4047728**079440**

Bit holder with hinge

- 20° angular movement
- Bit holder can be locked in position
- For impact operation



6.3 1/4" 6.3 1/4"

NEW

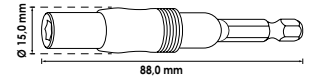

Socket adapter set

6.3 1/4" 10 3/8" 12.5 1/2" 6.3 1/4"

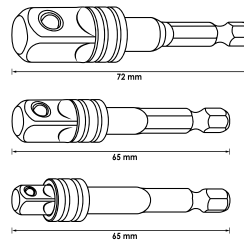

NEW

VIGOR No.	EAN 4047728+	
V7603/3	079471	

Socket adapter · with hinge

- 20° angular movement
- Socket adapter can be locked in position
- For impact operation



6.3 1/4" 6.3 1/4"

NEW

VIGOR No.	mm	EAN 4047728+	
V7614	90	079457	

Socket adapter · with hinge

- 20° angular movement
- Socket adapter can be locked in position
- For impact operation



10 3/8" 6.3 1/4"

NEW

VIGOR No.	mm	EAN 4047728+	
V7638	92	079464	



V5019, EAN 4047728050197

Bit box

- ~ DIN / ISO



XX	■		Design	Size
7 x	6.3 1/4"			T10 · T15 · T20 · T25 · T27 · T30 · T40
4 x	6.3 1/4"			3 · 4 · 5 · 6 mm
3 x	6.3 1/4"			PH1 · PH2 · PH3
3 x	6.3 1/4"			PZ1 · PZ2 · PZ3
4 x	6.3 1/4"			0.5x3 · 0.8x4 · 1x5 · 1x6 mm
7 x	6.3 1/4"			T10H · T15H · T20H · T25H · T27H · T30H · T40H
1 x	6.3 1/4"			60 mm
1 x	6.3 1/4"			25 mm

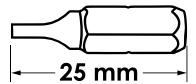

V5502, EAN 4047728055024

Bit box

- Work with screws in the workshop, industry, trade, at home and for hobby use
- ~ DIN / ISO



XX	■		Design	Size
7 x	6.3 1/4"			T10 · T15 · T20 · T25 · T27 · T30 · T40
4 x	6.3 1/4"			3 · 4 · 5 · 6 mm
3 x	6.3 1/4"			PH1 · PH2 · PH3
3 x	6.3 1/4"			PZ1 · PZ2 · PZ3
4 x	6.3 1/4"			0.5x3 · 0.8x4 · 1x5 · 1x6 mm
7 x	6.3 1/4"			T10H · T15H · T20H · T25H · T27H · T30H · T40H
1 x	-			95 mm
1 x	6.3 1/4"			60 mm

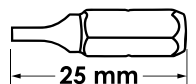

Screwdrivers and bits



V5020, EAN 4047728050203

Bit box

• ~ DIN / ISO



			Design	Size
7 x				T10 · T15 · T20 · T25 · T27 · T30 · T40
2 x				T20 · T25
3 x				3 · 4 · 5 mm
3 x				PH1 · PH2 · PH3
2 x				PH1 · PH2
3 x				PZ1 · PZ2 · PZ3
2 x				PZ1 · PZ2
3 x				0.5x3 · 0.8x4 · 1x5 mm
1 x				1x6 mm
7 x				T10H · T15H · T20H · T25H · T27H · T30H · T40H
1 x				60 mm
1 x				25 mm

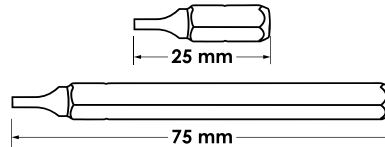

V6068, EAN 4047728060684

Bit box

• ~ DIN / ISO



Including sales display for a purchase of at least 10 pieces



			Design	Size
7 x				T10 · T15 · T20 · T25 · T27 · T30 · T40
4 x				3 · 4 · 5 · 6 mm
3 x				PH1 · PH2 · PH3
3 x				PZ1 · PZ2 · PZ3
4 x				0.5x3 · 0.8x4 · 1x5 · 1.2x6.5 mm

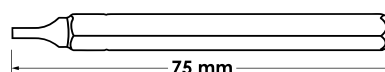

V7784, EAN 4047728**077842**

Ratcheting wrench with screwdriver bit set

- Good accessibility for hard-to-reach places: Screwdriver bits are inserted in the ratchet → ratchet head height very low
- Screwdriver bit assortment with 10 mm hexagon socket
- 2 sockets:
Rigid side for loosening tight screw connections
Bit ratchet socket with fine toothing of 72 teeth
- Length of ratcheting wrench: 250 mm

10 ³/₈"



40

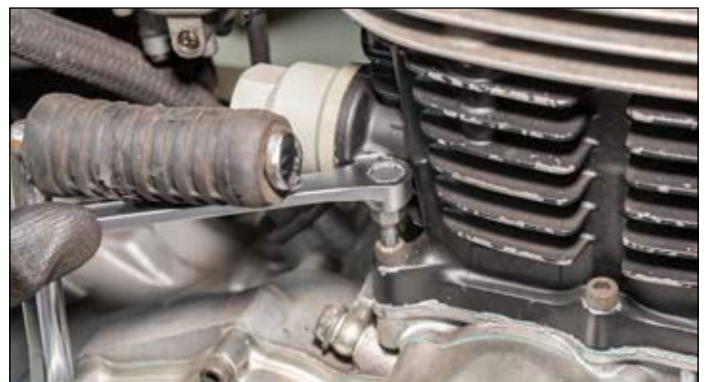

XX	■		Design	Size
10 x	10 ³ / ₈ "			T10 · T15 · T20 · T25 · T27 · T30 · T40 · T45 · T50 · T55
10 x	10 ³ / ₈ "			T10H · T15H · T20H · T25H · T27H · T30H · T40H · T45H · T50H · T55H
6 x	10 ³ / ₈ "			4 · 5 · 6 · 7 · 8 · 10 mm
6 x	10 ³ / ₈ "			M4 · M5 · M6 · M8 · M10 · M12
6 x	10 ³ / ₈ "			M5 · M6 · M7 · M8 · M9 · M10

Pliers



V5650, EAN 4047728056502

Diagonal cutter with double joint

- Extremely slim design
- For working in areas with restricted access

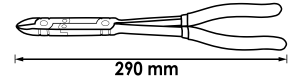

V2781, EAN 4047728027816

Combination pliers with double joint

- Toothed, extremely slim design
- For working in areas with restricted access

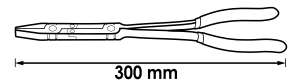

V2782, EAN 4047728027823

Snipe nose pliers with double joint

- Toothed, extremely slim design
- For working in areas with restricted access

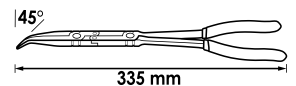

V2783, EAN 4047728027830

Snipe nose pliers with double joint

- Toothed, extremely slim design
- For working in areas with restricted access

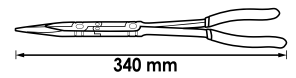

V5493, EAN 4047728054935

Spark plug pliers with double joint

- Installing and removing hard-to-reach spark plug sockets
- Also for severing fuel line connections
- 45° angled head

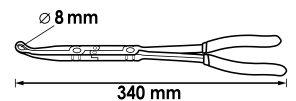

Safe application thanks to integrated teeth



V5494, EAN 4047728054942

Spark plug pliers with double joint

- Installing and removing hard-to-reach spark plug sockets
- Also for severing fuel line connections
- 45° angled head

Safe application thanks to integrated teeth

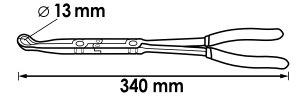

V5496, EAN 4047728054966

Circlip pliers with double joint · inside locking

- Inside lockings (bore holes) 8 – 30 mm Ø
- Particularly simple tip replacement
- Colour coded tips
- Design tips / contents:
 - 2xØ 1.0 mm straight
 - 2xØ 1.0 mm 90° angled
 - 2xØ 1.3 mm straight
 - 2xØ 1.3 mm 90° angled
 - 2xØ 1.8 mm straight
- 1 x inside hexagon socket wrench

Double joint exponentially increases and transmits even the smallest of handle movements to the tips

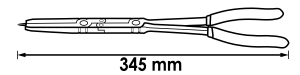

V5496-1, EAN 4047728054980

Replacement tip set for circlip pliers with double joint

- Circlip pliers with double joint V5496 · V5497
- Contents:
 - 2xØ 1.0 mm · straight
 - 2xØ 1.0 mm · 90° angled
 - 2xØ 1.3 mm · straight
 - 2xØ 1.3 mm · 90° angled
 - 2xØ 1.8 mm · straight
 - 1 x inside hexagon socket wrench



V5497, EAN 4047728054973

Circlip pliers with double joint · outside locking

- Outside lockings (shafts) 12 – 30 mm Ø
- Particularly simple tip replacement
- Colour coded tips
- Design tips / contents:
 - 2xØ 1.0 mm straight
 - 2xØ 1.0 mm 90° angled
 - 2xØ 1.3 mm straight
 - 2xØ 1.3 mm 90° angled
 - 2xØ 1.8 mm straight
- 1 x inside hexagon socket wrench

Double joint exponentially increases and transmits even the smallest of handle movements to the tips

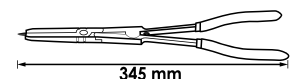

Pliers



V6510-10/4, EAN 4047728076951

Circlip pliers set · 140 mm



XX	Design	Size
1 x		140 mm
1 x		140 mm
1 x		140 mm
1 x		140 mm

V6510-19/4, EAN 4047728076968

Circlip pliers set · 180 mm



XX	Design	Size
1 x		180 mm
1 x		180 mm
1 x		180 mm
1 x		180 mm

Circlip pliers

- For outside lockrings
- Form A
- Straight design

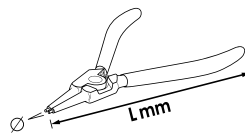

VIGOR No.	● mm	≡ mm	← L → mm	EAN 4047728+
V6510A-10	10-25 mm	1.3	140	076807
V6510A-19	19-60 mm	1.8	180	076814
V6510A-40	40-100 mm	2.3	230	076821

Circlip pliers

- For outside lockrings
- Form B
- Angled

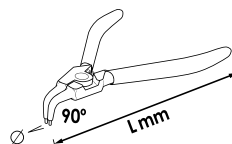

VIGOR No.	● mm	≡ mm	← L → mm	EAN 4047728+
V6510B-10	10-25 mm	1.3	140	076838
V6510B-19	19-60 mm	1.8	180	076845
V6510B-40	40-100 mm	2.3	230	076852



Circlip pliers

- For inside lockrings
- Form C
- Straight design

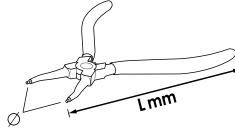

VIGOR No.	mm	mm	L mm	EAN 4047728+
V6510C-12	12-25 mm	1.3	140	076869
V6510C-19	19-60 mm	1.8	180	076876
V6510C-40	40-100 mm	2.3	230	076883

Circlip pliers

- For inside lockrings
- Form D
- Angled

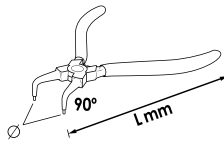

VIGOR No.	mm	mm	L mm	EAN 4047728+
V6510D-12	12-25 mm	1.3	140	077248
V6510D-19	19-60 mm	1.8	180	076906
V6510D-40	40-100 mm	2.3	230	076913

Grip pliers with curved jaws

- Safe gripping of nuts or screw heads
- Size adjustment with adjusting screw
- Locking element on handle
- Toothed inside of jaws
- Ergonomically shaped, easy to handle
- Chrome Molybdenum
- Nickel-plated

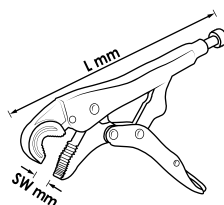

VIGOR No.	Size	L mm	EAN 4047728+
V3738-S	6 - 13 mm	100	069540
V3738	11 - 19 mm	175	037389
V3739	16 - 27 mm	250	037396

Wire cutter



V1808, EAN 4047728018081

Grip pliers set

- Size adjustment with adjusting screw
- Locking element on handle
- Toothed inside of jaws
- Ergonomically shaped, easy to handle
- Chrome Molybdenum
- Nickel-plated



Delivery in practical tool roll



VIGOR No.	Designation	Design	mm	EAN 4047728+
V1802	Grip pliers with long jaws		150	018029
V1803	Grip pliers with long jaws		250	018036
V1804	Grip pliers with long jaws		125	018043



V4640, EAN 4047728081726

Hose clamp pliers

- For operating hose and spring band hose clamp
- Rotatable jaws for confined spaces
- Locking element for temporary holding of the clamp



V4637N, EAN 4047728075565

Hose and spring band clamp pliers

- Operation of self-gripping hose clamps and spring band clamps which are hard to reach
- Bowden cable locking element for temporary holding of the clamp
- Easy release of the lock due to internal spring
- Fatigue-free work due to internal spring in handle
- Total length of bowden cable: 590 mm
- Clamping range: 18–53 mm



V4737, EAN 4047728075572

Fuel line pliers

- Operation of hard-to-reach fuel line clutches
- Flexible bowden cable
- No damage to the clutches and hoses due to proper operation of quick-release fasteners
- Bowden cable locking element facilitates precise adjustment of the range
- Easy release of the lock due to internal spring
- Total length of bowden cable: 590 mm
- Opening width: 30 mm



V4641, EAN 4047728075558

Clamp pliers

- Operation of stepless and earless clamps on axle boots (also thermoplast axle boots)
- Precise tightening through even compression

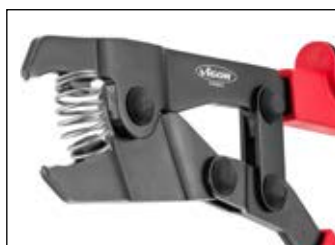

Pliers



V4196, EAN 4047728041966

Pliers for plastic rivets



Including 40 plastic rivets

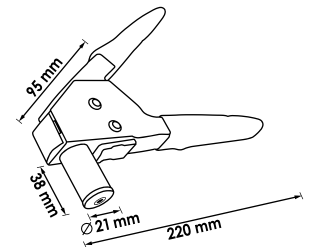

V6799, EAN 4047728067997

Flexible hose clamp set

- Disconnecting flexible hose lines
- Secure, adjustable latching
- Maintenance work with petrol, radiator antifreeze, oil, etc.
- Temperature resistance up to 220°C

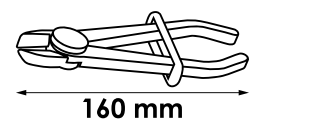
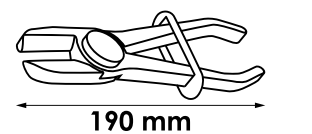
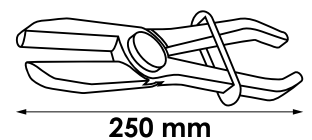

V3735, EAN 4047728**037358**

Hand riveting tool for blind rivets and rivet nuts · universal

- Rivet nuts: M5 · M6 · M8 · M10 for rivets made of copper, brass, steel and stainless steel
- Blind rivets: 3.2 · 4.0 · 4.8 · 6.4 mm for rivets made of copper, brass, steel and stainless steel



Spare parts

VIGOR No.	Designation	EAN 4047728+
V3735-3.2	Mouthpiece for blind rivets · 3.2 mm	053976
V3735-4.0	Mouthpiece for blind rivets · 4.0 mm	053617
V3735-4.8	Mouthpiece for blind rivets · 4.8 mm	053624
V3735-6.4	Mouthpiece for blind rivets · 6.4 mm	053631
V3735-M5	Mouthpiece for rivet nuts · M 5	053495
V3735-M6	Mouthpiece for rivet nuts · M 6	053501
V3735-M8	Mouthpiece for rivet nuts · M 8	053518
V3735-M10	Mouthpiece for rivet nuts · M 10	053525

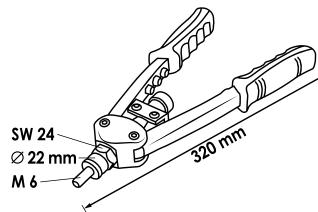

V2788, EAN 4047728**027885**

Blind rivet pliers

- For blind rivets: 3.2 · 4.0 · 4.8 · 6.4 mm
- For rivets made of copper, brass, steel and stainless steel
- Very low power required, extra short design



Spare parts

VIGOR No.	Designation	EAN 4047728+
V2788-3.2	Mouthpiece for blind rivets · 3.2 mm	053648
V2788-4.0	Mouthpiece for blind rivets · 4.0 mm	053655
V2788-4.8	Mouthpiece for blind rivets · 4.8 mm	053662
V2788-6.4	Mouthpiece for blind rivets · 6.4 mm	053679

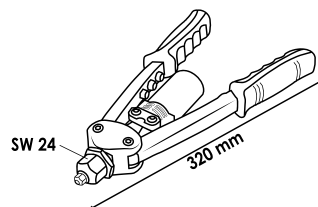



Diagonal cutter



VIGOR No.	mm	EAN 4047728+
V6500-140	140	076753
V6500-160	160	076746



Combination pliers



VIGOR No.	mm	EAN 4047728+
V6501-180	180	076760



Snipe nose pliers



VIGOR No.	mm	EAN 4047728+
V6502-200	200	076777



Snipe nose pliers · angled



VIGOR No.	mm	EAN 4047728+
V6503-200	200	076791



Pipe wrench

- Robust cast iron pliers body enables high power transmission
- Quick canting and release on the workpiece due to internal spring
- Coarse jaw serration for optimum grip
- Jaw opening: up to 60mm
- Capacity for pipes \varnothing 50mm · 2"



NEW

VIGOR No.	L mm	EAN 4047728+
V5639	350	075589
V5639-24	620	081719

V6504-250, EAN 4047728077750

Universal pliers · with push button

- – Universal pliers –
- Adjustment of the jaw opening at the touch of a button
- Locking of the hinge pin prevents unintentional adjustment
- Jaw opening: up to 65mm
- Capacity for nuts · size 46 mm
- Capacity for pipes \varnothing 50mm · \varnothing 2"
- Adjustment positions: 23

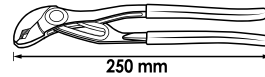

V5681, EAN 4047728056816

Electronic diagonal cutter

- For wire classes:
 - Soft up to \varnothing 1.6 mm
 - Medium-hard up to \varnothing 1.2 mm
 - Hard up to \varnothing 0.8 mm

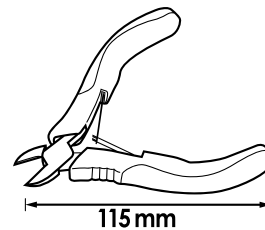

V5632, EAN 4047728080279

VDE tool set

- Compact tool case with all the tools needed to safely de-energise a vehicle
- Certified according to DIN EN 60900 up to 1000 volts alternating voltage or 1500 volts direct voltage
- For manual operation



NEW

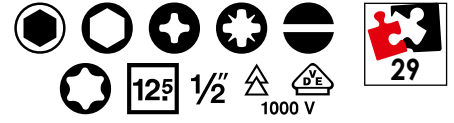

XX	■		Design	Size
3 x	125 1/2	○		5 · 8 · 6 mm
1 x	-	125 1/2		255 mm
9 x	125 1/2	●		8 · 10 · 12 · 13 · 14 · 17 · 19 · 22 · 24 mm
1 x	125 1/2	125 1/2		125 mm
1 x	-	-		200 mm
1 x	-	-		160 mm
1 x	-	-		180 mm
1 x	-	-		251 mm
4 x	-	⊕		T30 · T25 · T20 · T15
4 x	-	⊖		0.5x3 · 0.8x4 · 1x5.5 · 1.2x6.5 mm
3 x	-	⊕		PH0 · PH1 · PH2

V3343, EAN 4047728033435

VDE socket set

- VDE insulated up to 1000 V as per DIN EN 60900
- IEC 60900:2018
- For manual operation

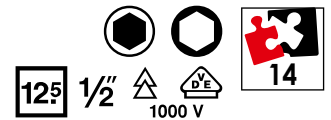

XX	■		Design	Size
9 x	125 1/2	●		8 · 10 · 12 · 13 · 14 · 17 · 19 · 22 · 24 mm
3 x	125 1/2	○		5 · 6 · 8 mm
1 x	125 1/2	125 1/2		125 mm
1 x	-	125 1/2		255 mm

VDE reversible ratchet

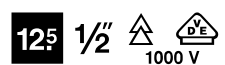

VIGOR No.	mm	EAN
V3342	255	4047728+033428

VDE extension

12⁵ 1/2" **12⁵** 1/2" 1000 V



VIGOR No.	Size mm	EAN 4047728+
V3341	125	033411

VDE socket

12⁵ 1/2" 1000 V



VIGOR No.	Size	mm	EAN 4047728+
V3330	8 mm	55	033305
V3331	10 mm	55	033312
V3332	12 mm	55	033329
V3333	13 mm	55	033336
V3334	14 mm	55	033343
V3335	17 mm	55	033350
V3336	19 mm	55	033367
V3337	22 mm	55	033374
V3338	24 mm	55	033381

VDE screwdriver socket

12⁵ 1/2" 1000 V



VIGOR No.	Size	mm	EAN 4047728+
V3339	5 mm	78	033398
V3344	6 mm	78	033442
V3340	8 mm	78	033404

VDE screwdriver for slotted screws

• Manufactured according to DIN/ISO

1000 V **2 K**

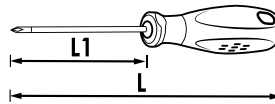

VIGOR No.	Size	L1 mm	mm	EAN 4047728+
V2028	0.5x3 mm	100	181	020282
V2029	0.8x4 mm	100	181	020299
V2030	1x5.5 mm	125	231	020305
V2061	1.2x6.5 mm	150	256	020619

VDE Phillips-Recess screwdriver

• Manufactured according to DIN/ISO

1000 V **2 K**

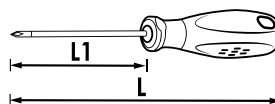

VIGOR No.	Size	L1 mm	mm	EAN 4047728+
V2062	PH0	60	141	020626
V2063	PH1	80	161	020633
V2064	PH2	100	206	020640

VDE T profile screwdriver

• Manufactured according to DIN/ISO

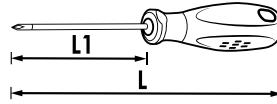

VIGOR No.	Size	L1 mm	L mm	EAN 4047728+
V2031-T15	T15	100	180	078122
V2031-T20	T20	100	180	078115
V2031-T25	T25	125	230	078092
V2031-T30	T30	150	250	078139

V2027, EAN 4047728020275

VDE screwdriver set

• Manufactured according to DIN/ISO



XX	Design	Size
4 x		0.5x3 · 0.8x4 · 1x5.5 · 1.2x6.5 mm
3 x		PH0 · PH1 · PH2

Voltmeter



VIGOR No.	Size	mm	EAN 4047728+
V1138	0.5x3 mm	140	011389

V5631, EAN 4047728077941

VDE universal pliers

• VDE insulated up to 1000 V as per DIN EN 60900
• IEC 60900:2018





V2641, EAN 4047728**026413**

VDE round nose pliers

• Long jaws

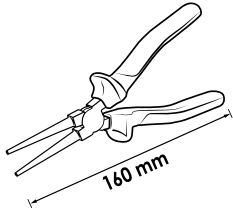

V2628, EAN 4047728**026284**

VDE combination pliers

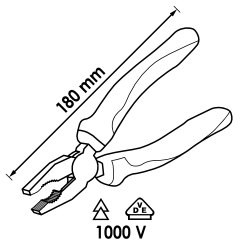

V2629, EAN 4047728**026291**

VDE diagonal cutter

• For hard wire (H)

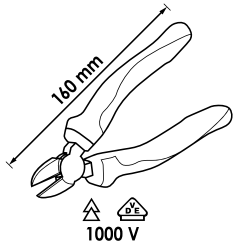

V2630, EAN 4047728**026307**

VDE snipe nose pliers

• With blade

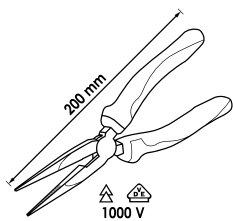

V2643, EAN 4047728**026437**

VDE wire stripper

• Spring and adjusting screw

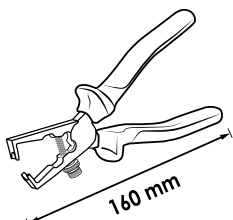

Machinist's hammer

- Ash stick



VIGOR No.	— L — mm	⚖ kg	EAN 4047728+
V1135	300	300 g	011358
V2662	320	500 g	026628
V2665	350	800 g	026659
V2664	360	1000 g	026642
V2663	400	2000 g	026635

Club hammer

- Ash stick



VIGOR No.	— L — mm	⚖ kg	EAN 4047728+
V4235	280	1500 g	042352

Plastic soft-faced hammer

- Replaceable heads made from impact-resistant cellulose acetate
- Ash stick



VIGOR No.	Diameter max	— L — mm	EAN 4047728+
V1212	32	280	012126
V4661	40	320	046619



VIGOR No.	Designation	∅ mm	EAN 4047728+
V3541	Spare head (pair) for plastic soft-faced hammer V1212	32	035415
V4661-1	Spare head (pair) for plastic soft-faced hammer V4661	40	048514



V1221, EAN 4047728012218

Flat chisel



V1222, EAN 4047728012225

Cape chisel

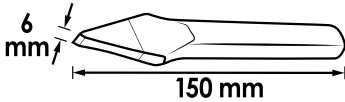

V1220, EAN 4047728012201

Centre punch

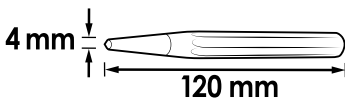

V1783, EAN 4047728017831

Centre punch · self-punching

- The impact force is applied by simply pressing down the upper part

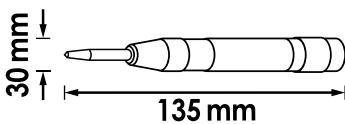

Drift pin



VIGOR No.	Ø	mm	EAN 4047728+
V1214	2	150	012140
V1215	3	150	012157
V1216	4	150	012164
V1217	5	150	012171
V1218	6	150	012188
V1219	8	150	012195

V1283, EAN 4047728012836

Scraper set · stainless steel

- Removing sealing residues on cylinder head lid, valve cover, carburettor cover gaskets, etc.
- Stainless steel blades
- Hanging hole
- Set of 4 pieces

With impact cap

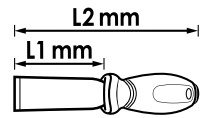

VIGOR No.	mm	mm	Chisel height	EAN 4047728+
V2487	230	32	1.2	024877
V2488	230	32	2.5	024884
V2509	175	20	1.2	025096
V2508	175	20	2.5	025089

V1368N, EAN 4047728071017

Universal scraper

- Removal of vignettes, badges and stickers
- Also suitable for ceramic glass cooktop, windscreen, etc.
- Blade can be replaced quickly and safely
- Including one blade

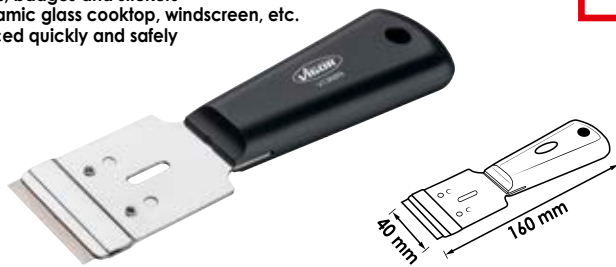

V1372, EAN 4047728013727

Spare blades



V1213, EAN 4047728012133

Gasket scraper · long

- Removing sealing residues on cylinder head lid, valve cover, carburettor cover gaskets, etc.
- Long design
- Plastic handle

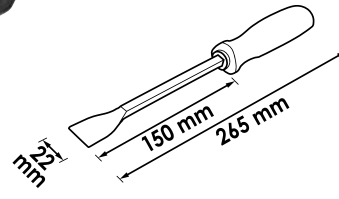

V4663, EAN 4047728046633

Mini hook set

- Inserting and removing O-rings or seals
- Also for removing the protection caps on wheel bolts
- Hanging hole
- Short design



V5045, EAN 4047728050456

Hook and scraper set

- Removing and inserting O-rings and seals and for removing stickers and the remains of seals and adhesive
- Also for removing the protection caps on wheel bolts
- With hanging hole

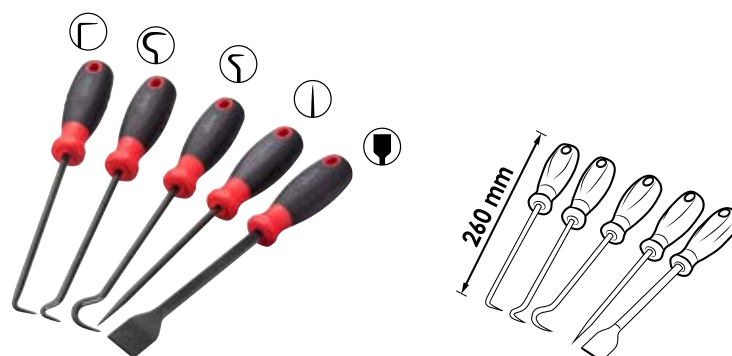

V6210-4, EAN 4047728065948

Centre punch

- Labelling of components to be processed
- Ergonomic two-component handle
- Safe gripping
- Reduced vibrations when hitting
- Elongated impact cap
- Tip Ø 4 mm
- Centre punch 4x10x185 mm



V6210-10, EAN 4047728065931

Centre punch

- Labelling of components to be processed
- Ergonomic two-component handle
- Safe gripping
- Reduced vibrations when hitting
- Elongated impact cap
- Tip Ø 10 mm
- Centre punch 10x12x185 mm



V6230-5, EAN 4047728065986

Cape chisel

- Safe, easy disconnection of components or parts
- Ergonomic two-component handle
- Safe gripping
- Reduced vibrations when hitting
- Elongated impact cap
- Blade width: 5 mm
- Cape chisel 5x10x170 mm



V6230-7, EAN 4047728065993

Cape chisel

- Safe, easy disconnection of components or parts
- Ergonomic two-component handle
- Safe gripping
- Reduced vibrations when hitting
- Elongated impact cap
- Blade width: 7 mm
- Cape chisel 7x12x190 mm



V6200, EAN 4047728061940

Drift pin set

- Ergonomically 2-component handle
- Safe gripping
- Significantly reduced risk of injury thanks to hand guard
- Reduced vibrations when hitting
- Elongated impact cap
- 7 different sizes (driving mandrel \varnothing 2 – 8 mm)
- Storage in practical tool roll

VIGOR No.	\varnothing	L mm	EAN 4047728+
V6200-2	2	140	061957
V6200-3	3	150	061964
V6200-4	4	180	061971
V6200-5	5	200	061988
V6200-6	6	210	061995
V6200-7	7	210	062008
V6200-8	8	220	062015



V6220/4, EAN 4047728066006

Flat chisel set

- Safe, easy disconnection of components or parts
- Ergonomic two-component handle
- Safe gripping
- Reduced vibrations when hitting
- Elongated impact cap
- 4 different sizes: 10 · 16 · 20 · 29 mm
- Storage in practical tool roll

VIGOR No.	L mm	$\frac{1}{2}$ mm	Chisel height	EAN 4047728+
V6220-10	140	10	8	065955
V6220-16	170	16	10	065962
V6220-20	210	20	14	065979
V6220-29	250	29	18	063890



V6030, EAN 4047728060301

Scraper set

- Removing badges, stickers, vignettes or adhesive residue, etc.
- Further application fields: removal of motor seals, e.g. on the cylinder head or valve cover
- Blades can be easily replaced by loosening the screw connection on the chuck
- Different blades enable adaptation to different application fields



VIGOR No.	Designation	$\frac{1}{2}$ mm	EAN 4047728+
V6030-12	Spare blades	12	062121
V6030-16	Spare blades	16	062138
V6030-20	Spare blades	20	062145



V1371, EAN 4047728069687

Removal lever set

- Ideal for working on door panels, dashboards, rubber seals, decorative strips, etc.
- Slim and robust design
- Versatile in use in workshop or household



VIGOR No.	EAN 4047728+
V1371-1	069649
V1371-2	069700
V1371-3	069656
V1371-4	069694
V1371-5	069670
V1371-6	069632
V2491	024914
V2492	024921
V2493	024938
V2494	024945
V2495	024952

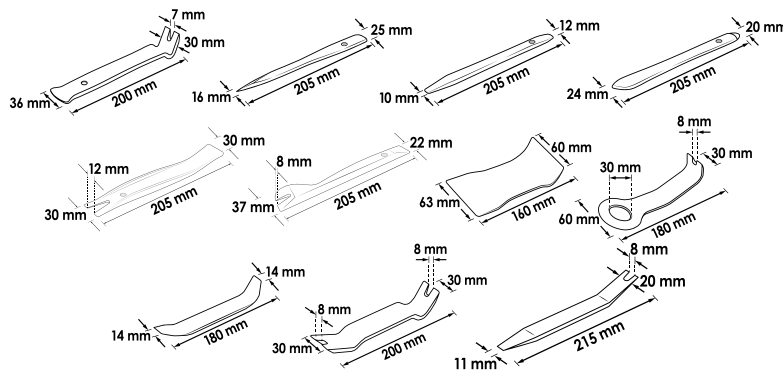

In practical tool roll



V1369, EAN 4047728013697

Removal lever set

- Ideal for working on door panels, dashboards, rubber seals, decorative strips, etc.
- Does not cause scratches
- Slim and robust design
- Versatile in use in workshop or household



VIGOR No.	l mm	h mm	EAN 4047728+
V2491	160	60	024914
V2492	180	30	024921
V2493	180	20	024938
V2494	200	30	024945
V2495	210	20	024952

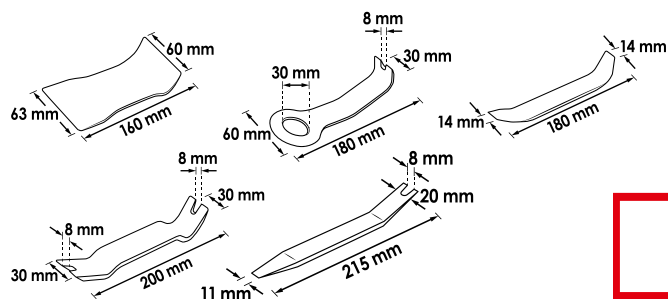

V4885, EAN 4047728**048859**

Clip loosening set

- Metal and plastic clips of vehicle trims
- Hanging hole

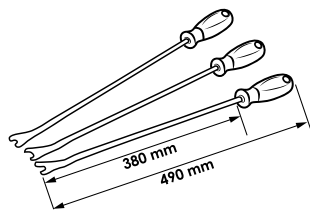

V5885, EAN 4047728**073851**

Clip loosening set

- Metal and plastic clips of vehicle trims
- Hanging hole

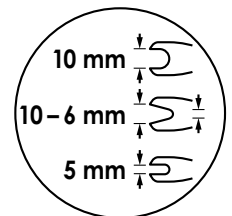
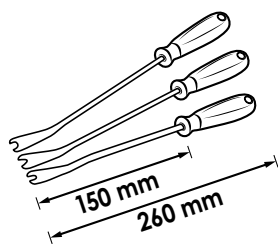

V4310N, EAN 4047728**062817**

Release lever

- Slim design – for working in areas that are difficult to access e.g. for removing the plastic clips from door and tailgate trims
- Length: 165 mm

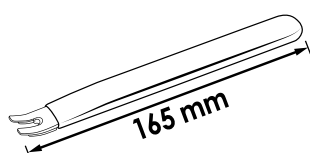

Plastic sleeve for damage-free work



V1301, EAN 4047728013017

Pry bar set

- Impact-resistant handle



V6952, EAN 4047728069526

Mini removal lever set

- Replacing the batteries in car keys or working on the dashboard
- Convenient, fine and versatile in use



Damage-free working on lacquered areas



V5591, EAN 4047728055918

Tape measure

- Determining short distances up to 5 m accurate to the millimetre
- Length: 5 m, width: 19 mm
- Wrist strap and belt clip
- Magnetic stopper
- Hand-regulated belt feed and belt stop
- Spring band steel



V1714, EAN 4047728017145

Feeler gauge set

- Testing of gap dimensions, contact gaps, hollow spaces
- Locknut
- Sheets conically shaped
- 20 sheets
- 0.05 – 1.00 mm



Various hand tools

Cutting and sawing



V4690, EAN 4047728**046909**

Vernier calliper · analogue

- External and internal measurements in the 0 – 150 mm range
- Millimetre and inch increments
- Nonius 0.05 mm and 1/128"
- Fixing screw
- Dipstick
- In plastic box
- DIN 862



V1713, EAN 4047728**017138**

Vernier calliper · digital

- External and internal measurements in the 0 – 150 mm range
- Millimetre and inch increments
- Digital display
- 1.5 V (LR 44) – 180 mAh
- Fixing screw
- Dipstick
- In plastic box



Can be switched between mm / inches



V1304, EAN 4047728**013048**

Universal scissors

- Long, high-quality cutting edges
- Stainless steel blade

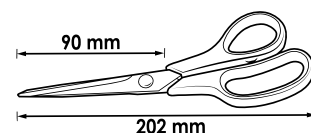

V1715, EAN 4047728**017152**

Saw frame

- Standard saw blades

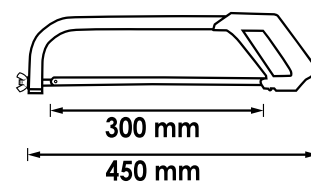

V2790N, EAN 4047728075664

Hack saw · small

- Standard saw blades

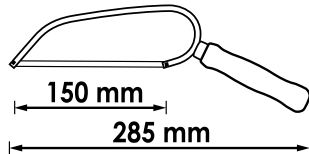
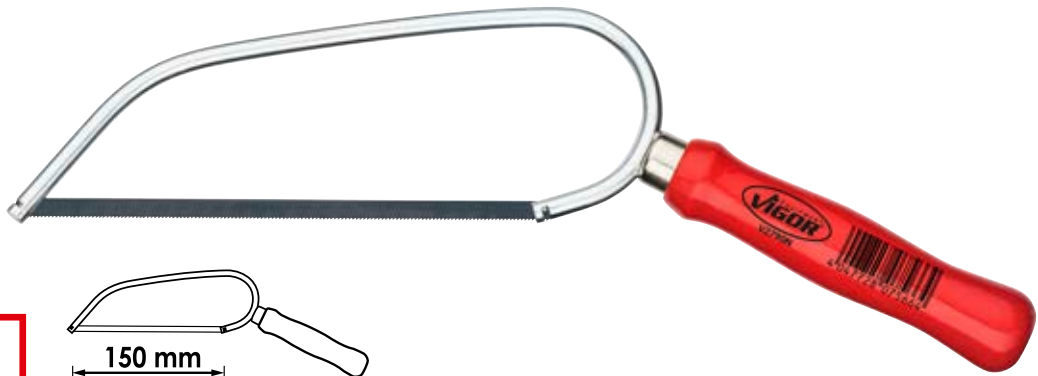

V4651, EAN 4047728046510

Jack-knife · outdoor

- Blade length: 86 mm
- Total length: 185 mm
- Stainless steel blade
- Aluminium grip housing



With locking element

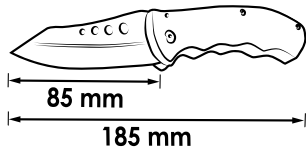

V2627, EAN 4047728026277

Universal knife

- Snap-off blade 9 mm
- Housing made of stainless steel
- Pocket clip



V4308, EAN 4047728043083

Snap-off blades · 9 mm

- Blades consist of 12 individual blades, which can be easily separated after wearing down
- For universal knife V2627

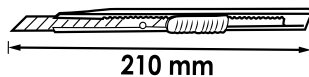

V4275, EAN 4047728042758

Universal knife

- Anti-slip convenient handle
- Steel-guided blade fixed for minimising accidents
- Quick-change magazine
- Includes 6 snap-off blades (V4274)



V4274, EAN 4047728042741

Snap-off blades · 18 mm

- Blades consist of eight individual blades, which can be easily separated after wearing down
- For universal knife V4275

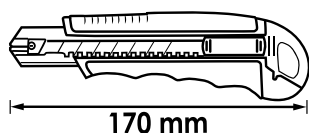

V7099, EAN 4047728070997

Universal jack-knife

- Universal use in the warehouse, garden, household, workshop or in industry
- Foldable, therefore reduced risk of injury
- Blade lock in open position
- Fast blade changes
- High-quality aluminium housing

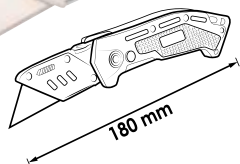

V1446, EAN 4047728014465

Trapezoid spare blades

- Can be used in two different ways due to trapezoidal shape
- For universal knife V1345 · V7099
- With two location notches



V7099/2, EAN 4047728071123

Universal jack-knife set

- Universal use in the warehouse, garden, household, workshop or in industry
- Foldable, therefore reduced risk of injury
- Blade lock in open position
- Fast blade changes
- High-quality aluminium housing

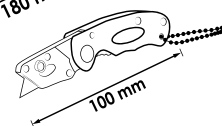
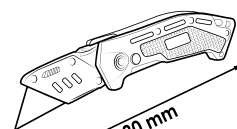

V1345, EAN 4047728013451

Universal knife

- Aluminium housing
- Quick-change magazine
- Including 10 trapezoid spare blades (V1446)

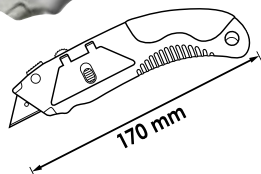

V1446, EAN 4047728014465

Trapezoid spare blades

- Can be used in two different ways due to trapezoidal shape
- For universal knife V1345 · V7099
- With two location notches



V1787, EAN 4047728017879

Flat hand file

- Teeth (cut): 2 = medium
- DIN 7261

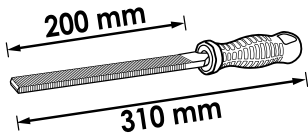

V1788, EAN 4047728017886

Three square file

- Teeth (cut): 2 = medium
- DIN 7261

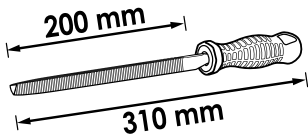

V1789, EAN 4047728017893

Square file

- Teeth (cut): 2 = medium
- DIN 7261

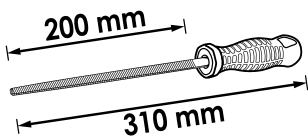

V1790, EAN 4047728017909

Half-round file

- Teeth (cut): 2 = medium
- DIN 7261

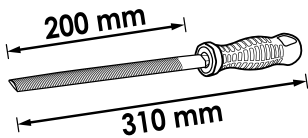

V1801, EAN 4047728018012

Round file

- Teeth (cut): 2 = medium
- DIN 7261

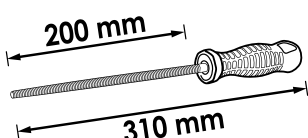

V2626, EAN 4047728026260

Ø 3 – 16 mm

Tube cutter

- For tubes made of copper, brass, light metal and PVC rigid



V3309, EAN 4047728033091

Ratcheting tube cutter for exhaust pipe

- For cutting stainless steel, steel, copper and aluminium
- Ratchet function:
 - Allows work even in hard-to-reach places
 - No need to guide the cutting handle around the pipe
- Working range: 32 – 67 mm
- Cutting depth: 3 mm



V3451, EAN 4047728034517

Spare blades

- Spare blades for ratcheting exhaust pipe cutter V3309



V1707, EAN 4047728017077

HSS step drill set



VIGOR No.	Ø mm	l mm	EAN 4047728+
V2394	4–12	65	023948
V2395	4–20	75	023955
V2396	4–30	100	023962



V6809-4, EAN 4047728067720

Steel wire brush · 4 rows

- Steel working
- Steel bristles
- Wire: 0.30 mm



V6807-4, EAN 4047728067713

Brass wire brush · 4 rows

- Gentle handling of sensitive surfaces
- Brass bristles
- Wire: 0.30 mm

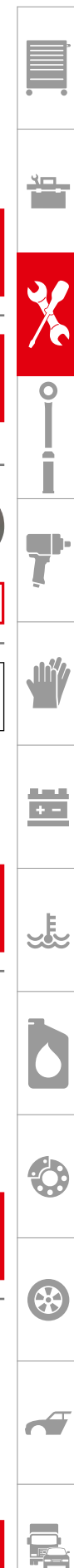

V6800-50, EAN 4047728067621

Cup brush · coarse

- Removal of coarse sediments and residues as well as stubborn rust
- Steel wire
- 6 mm clamping shaft
- Maximum 4500 rpm
- 50 mm Ø
- Trim size: 17 mm

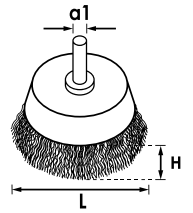

V6800-75, EAN 4047728067638

Cup brush · coarse

- Removal of coarse sediments and residues as well as stubborn rust
- Steel wire
- 6 mm clamping shaft
- Maximum 4500 rpm
- 75 mm Ø
- Trim size: 20 mm

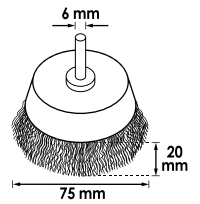

V6802, EAN 4047728067645

Wire end brush

- Deburring, paint removal, rust removal and cleaning
- Steel wire
- 25 mm Ø
- 6 mm clamping shaft
- Maximum 4500 rpm

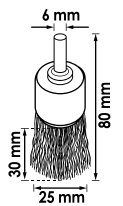

V6803-100, EAN 4047728067669

Wheel brush

- Removal of tempered colour on weld seams
- Steel wire
- 6 mm clamping shaft
- Maximum 4500 rpm
- 100 mm Ø

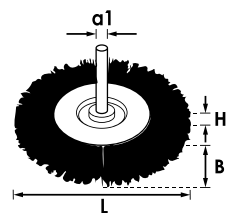

V6803-75, EAN 4047728067652

Wheel brush

- Removal of tempered colour on weld seams
- Steel wire
- 6 mm clamping shaft
- Maximum 4500 rpm
- 75 mm Ø

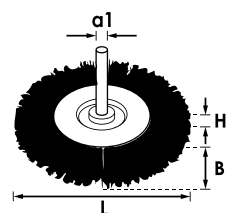

V6806, EAN 4047728067676

Wheel brush · knotted wire

- Removal of coarse sediments and residues as well as stubborn rust or scaling
- Steel wire
- Design with knotted wire
- 75 mm Ø
- Maximum 12500 rpm

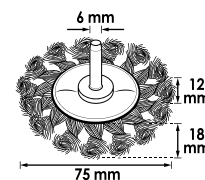

V6804, EAN 4047728067690

Wheel brush

- Deburring, paint removal, rust removal and cleaning
- Hardened steel wire
- Design with knotted wire
- 115 mm Ø
- Maximum 12500 rpm

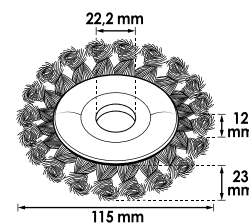

V6805, EAN 4047728067706

Bevel brush

- Cone-shaped for hard-to-reach areas
- Hardened steel wire
- Design with knotted wire
- 100 mm Ø
- Thread: M 14x2.0
- Maximum 12500 rpm

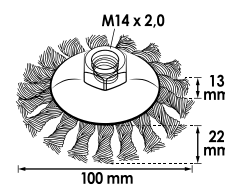

V6801-65, EAN 4047728067683

Cup brush

- Heavy brushing on large surfaces as well as for deburring, derusting and cleaning
- Steel wire
- Design with knotted wire
- 65 mm Ø
- Thread: M 14x2.0
- Maximum 12500 rpm

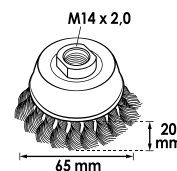



Torque tools

Torque wrenches



Torque wrench

- Torque release: palpable and audible
- Release accuracy tolerance $\pm 4\%$ of scale value (in direction of actuation)
- With serial number and certificate
- DIN EN ISO 6789-2:2017, DIN 3120, ISO 1174-1A
- 72 teeth
- 5° Opening angle



Torque technology „Made in Germany“

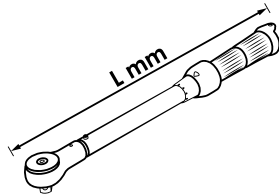

No more turning back

VIGOR No.	Nm	125 1/2	L mm	Tolerance	EAN 4047728+
V3898	20 - 120	125 1/2	445	4	038980
V3441	40 - 200	125 1/2	540	4	034418
V3899	60 - 320	125 1/2	610	4	038997

Fine-tooth reversible ratchet



Scale graduation: 1 Nm



Double scale: Nm and lbf.ft.



Handle with suspension lug



V2795, EAN 4047728027953

Rotation angle tester

- Fine resolution (0.1°)
- Rotation angle range up to 999° (adding)
- Angle measurement in clockwise and anti-clockwise direction
- Memory capacity up to 99 readings
- Indication of battery charge
- LED alarm indication (flashing)
- Buzzer alarm indication
- Audible alarm signal
- Automatic switch-off function





Pneumatic tools

Impact wrenches

231–232

Air ratchets

233

Die grinder

234

Pneumatic air blow and body protection guns

235
237

Hose reel

236

Impact wrenches



V5671N, EAN 4047728076715

Mini impact wrench

- Compact design for areas with restricted access
- Multiple power settings in forward and reverse with one-hand adjustment
- Exhaust air is guided downwards through the handle
- Cold insulated handle
- High performance single hammer striking mechanism
- Ergonomically shaped handle and housing for improved handling and operation
- Bumper on the housing side protects the air motor

12⁵ 1/2"



Maximum loosening torque 1200 Nm

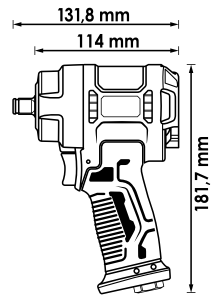

12.91(4) 7.2

Coupler plug included

VIGOR No.	12 ⁵ 1/2"	max. Nm	Nm	Nm	1/min	kg	Ø mm	l/min	bar	dB (A)	m/s ²	EAN 4047728+
V5671N	12 ⁵ 1/2"	850	600	1200	10000	1.28	10	141.5	6.3	95.3	6.81	076715

V4800N, EAN 4047728075633

Impact wrench

- Exhaust air is guided downwards through the handle
- Cold insulated handle
- High performance twin hammer mechanism
- Ergonomically shaped handle and housing for improved handling and operation
- Bumper on the housing side protects the air motor

ECO GIANT



12⁵ 1/2"



High performance twin hammer mechanism

Maximum loosening torque: 1720 Nm

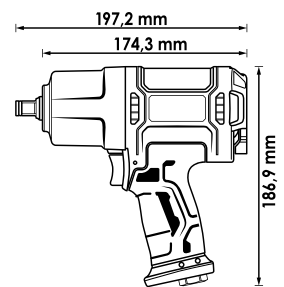

12.91(4) 7.2

Coupler plug included

VIGOR No.	12 ⁵ 1/2"	max. Nm	Nm	Nm	1/min	kg	Ø mm	l/min	bar	dB (A)	m/s ²	EAN 4047728+
V4800N	12 ⁵ 1/2"	1100	850	1720	7000	2.3	10	198.1	6.3	96.7	6.47	075633



V6899N, EAN 4047728076944

Impact wrench

- Multiple power settings in forward and reverse with one-hand adjustment
- Cold insulated handle
- Exhaust air is guided downwards through the handle
- High performance twin hammer mechanism
- Ergonomically shaped handle and housing for improved handling and operation
- Bumper on the housing side protects the air motor



20 3/4"



High performance twin hammer mechanism

Maximum loosening torque 2300 Nm

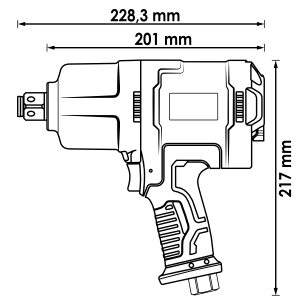

12.91 (w) 7.2

Coupler plug included

VIGOR No.	max. Nm	Nm	Nm	1/min	kg	Ø mm	l/min	bar	dB (A)	m/s ²	EAN	
V6899N	20 3/4"	2000	1400	2300	5500	3.6	13	254.8	6.3	97.9	5.75	4047728+076944

V3653, EAN 4047728036535

Impact wrench

- Multiple power settings in forward and reverse with one-hand adjustment
- Exhaust air is guided downwards through the handle
- Cold insulated handle
- High performance twin hammer mechanism
- Ergonomically shaped handle and housing for improved handling and operation

GIGA GIANT



12⁵ 1/2"



High performance twin hammer mechanism

Maximum loosening torque: 1890 Nm

Multiple power settings in forward and reverse with one-hand reversing switch

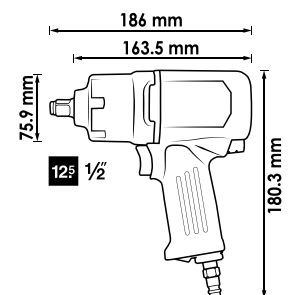

12.91 (w) 7.2

Coupler plug included

VIGOR No.	max. Nm	Nm	Nm	1/min	mm	kg	Ø mm	l/min	bar	dB (A)	m/s ²	EAN
V3653	12 ⁵ 1/2"	1290	700	1890	8500	1.95	10	113	6.3	96	12.92	4047728+036535

Air ratchets



V5674, EAN 4047728**056748**

Air ratchet

- For areas with restricted access
- Reversing switch on ratchet head

QUICKGIANT

6.3 1/4"



12,91 (e) 7.2

Coupler plug included

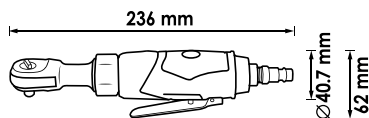

VIGOR No.	max. Nm	1/min	L mm	kg	Ø mm	l/min	bar	dB (A)	m/s ²	EAN 4047728+	
V5674	6.3 1/4"	35.2	240	236	0.6	10	77	6.3	87.5	3.47	056748

V6554, EAN 4047728**065542**

Air ratchet

- For areas with restricted access
- Reversing switch on ratchet head

QUICKGIANT

10 3/8"



12,91 (e) 7.2

Coupler plug included

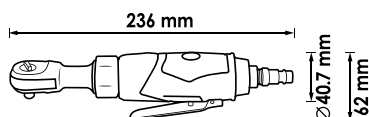

VIGOR No.	max. Nm	1/min	L mm	kg	Ø mm	l/min	bar	dB (A)	m/s ²	EAN 4047728+	
V6554	10 3/8"	35.2	240	236	0.6	10	77	6.3	87.5	3.47	065542

V5675, EAN 4047728**056755**

Air ratchet

- For areas with restricted access
- Reversing switch on ratchet head

QUICKGIANT

12.5 1/2"



12,91 (e) 7.2

Coupler plug included

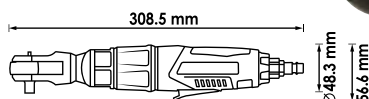

VIGOR No.	max. Nm	1/min	L mm	kg	Ø mm	l/min	bar	dB (A)	m/s ²	EAN 4047728+	
V5675	12.5 1/2"	67	160	308.5	1.2	10	114	6.3	100.5	3.47	056755



V5672, EAN 4047728056724

Die grinder · straight design

- Cutter, cutting wheels, grinding pads with 3 and 6 mm collet chuck

3 + 6 mm



Including Ø 3 mm collet chuck

Including Ø 6 mm collet chuck

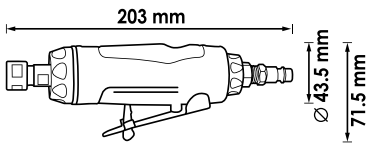

SPEED GIANT

12.91 (A) 7.2

Coupler plug included



VIGOR No.	mm	1/min	mm	W Watt	kg	Ø mm	l/min	bar	dB (A)	m/s ²	EAN 4047728+
V5672	3-6 mm	22000	203	350	0.54	10	128.2	6.3	97.1	2.90	056724

V5673, EAN 4047728056731

Die grinder · angled

- Cutter, cutting wheels, grinding pads with 3 and 6 mm collet chuck

3 + 6 mm



Including Ø 3 mm collet chuck

Including Ø 6 mm collet chuck

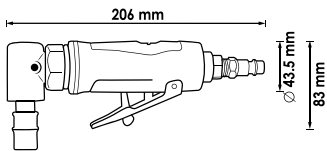

SPEED GIANT

12.91 (A) 7.2

Coupler plug included



VIGOR No.	mm	1/min	mm	W Watt	kg	Ø mm	l/min	bar	dB (A)	EAN 4047728+
V5673	3-6 mm	20000	206	250	0.45	10	85.5	6.3	101.6	056731

V6906, EAN 4047728069069

Die grinder set · mini

- Straight design
- Small design for areas with restricted access
- For grinding, polishing or deburring
- Including 3 and 6 mm collet chuck
- Exhaust air is guided downwards through the handle
- Including 10-piece grindstone set V6906-10

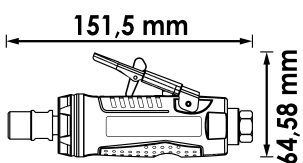

SPEED GIANT

12.91 (A) 7.2

Coupler plug included

V6906-10, EAN 4047728069571

Grindstone set

- Grinding stones for VIGOR die grinders V6906 · V5672 · V5673



VIGOR No.	mm	1/min	W Watt	kg	Ø mm	l/min	bar	dB (A)	EAN 4047728+
V6906	3-6 mm	25000	185	0.31	10	85	6.3	102	069069

Pneumatic air blow and body protection guns



V6905, EAN 4047728069052

Tyre inflator

- One-hand operation with ergonomic handle
- Rubber-coated manometer for protecting against small impacts
- Easily legible precision manometer with bar and PSI display
- Graduation: 0.1 bar
- Easily adjustable filling lever and discharge button, easy to reach on the handle
- Discharge button for levelling the filling capacity

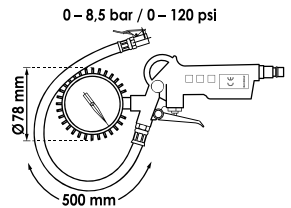

V7135, EAN 4047728071352

Air blow gun · short

- Fast removal and cleaning of chips and other foreign objects
- Long-life aluminium housing
- Suspension device incorporated

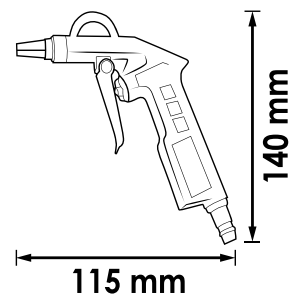

V7135-150, EAN 4047728071369

Air blow gun · long

- Fast removal and cleaning of chips and other foreign objects
- Long-life aluminium housing
- Suspension device incorporated

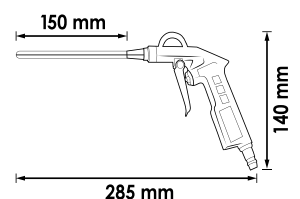

V7143-10, EAN 4047728071437

Hose reel

- Reduces danger of accident, as there is no hose lying around
- Compact housing including opening flap for the removal of dirt or to straighten the hose
- Wall holder: 180° pivotable
- Automatic roll up through guided feed
- Pneumatic adapter pre-installed
- Hybrid polymer hose
- Auto stop function
- Impact-resistant polypropylene housing
- Adapted pull-in force
- Maximum working pressure: 12 bar

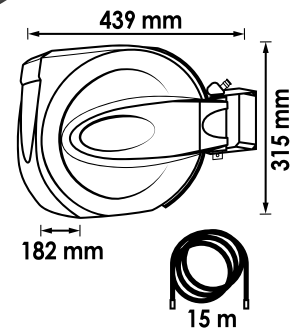

V4322, EAN 4047728043229

Underbody protection gun

- Can be used with all common cartridges of 1000 ml
- The flexible 500 mm hose supplied with nozzle for spreading wax allows for an effortless application of wax in hollow spaces
- Simple application of the underbody protection (or noise protection) with nozzle installed as standard
- Application recommendation: Open cartridge, insert suction tube, tighten cartridge. Complete.

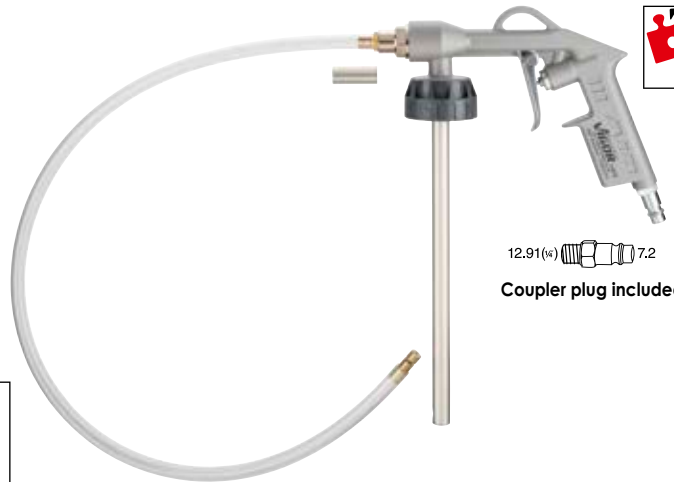

12.91(e) 7.2

Coupler plug included



V6907, EAN 4047728075497

Mini grease gun

- Grease tube can be changed quickly due to the screw thread
- Feed rate: 0.45 ml/stroke
- Lubricating nipple in 30° and 90° designs
- Inside thread M15x1.5



V6907-1, EAN 4047728075503

High performance lubricant

- Grease from striking mechanisms, spindles and screw connections
- Replacement grease tube for V6907
- Corrosion protection thanks to good adhesion on metallic surfaces
- Filling capacity: 100 ml
- Outside thread: M 15x1.5





**General
workshop tools**

V4241, EAN 4047728042413

Control cabinet key Sub Maker Quadro 10-in-1

- For almost all standard locking systems in plumbing, heating, construction, ventilation, air conditioning etc.

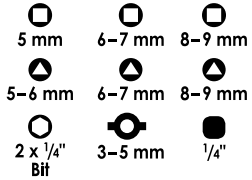

MADE IN GERMANY



V4228, EAN 4047728042284

Site key MasterKey construction

- For standard locking systems in plumbing, heating, construction, ventilation, air conditioning etc.
- Square mandrel allows the lock follower to be operated without a door handle or square pin

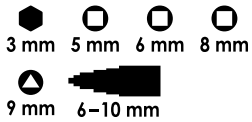

MADE IN GERMANY

Zinc pressure casting



V4227, EAN 4047728042277

Site key MasterKey electronics

- For almost all standard locking systems in plumbing, electronics, heating, ventilation, air conditioning etc.

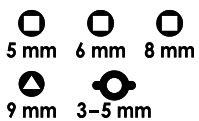

MADE IN GERMANY

Zinc pressure casting



V4279, EAN 4047728**042796**

Set of Japan spatulas · metal

- Applying material or smoothing surfaces, as well as for use in several other application fields
- Width of spatula 50 · 80 · 100 · 120 mm

MADE IN GERMANY



Made from highly flexible spring steel strip



V4278, EAN 4047728**042789**

Set of Japan spatulas · plastic

- Applying material or smoothing surfaces, as well as for use in several other application fields
- For work on the body, e.g. filling holes and dents as well as several other application fields
- Width of spatula 50 · 80 · 100 · 120 mm

MADE IN GERMANY



V5480, EAN 4047728**054799**

Telescopic inspection mirror set

- Visual inspection in areas with restricted access
- Double joint with tension spring for a view of hard to reach areas
- Replaceable mirror thanks to quick change system with 6.3 mm socket

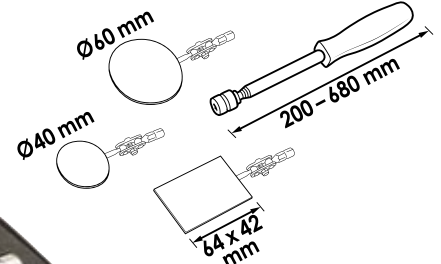

Mirror changeable using quick-change system



Quick identification of e.g. oil loss, corrosion or cable connections



V1740, EAN 4047728068673

Magnetic pick-up tool · semi-flexible

- Extendable magnet for selective pick-up
- High-quality plastic handle
- Semi-flexible shank



V1741, EAN 4047728017411

Telescopic magnetic pick-up tool

- Picking up parts containing iron even in inaccessible parts
- Telescoping
- Practical bag clip



V1764, EAN 4047728017640

Pick-up tool with claws and magnet · flexible

- For picking up small parts such as screws, nuts, etc. at inaccessible places
- With magnet for additional grip
- Gripping and magnetic function



V1438, EAN 4047728014380

Tweezers set

- Ideal for working e.g. in hard-to-reach areas
- Easy grip
- Stainless steel



V5512, EAN 4047728055123

Gas soldering iron set

- Soldering, melting, shrinking and hot cutting work with seven different adapters
- Flexible, stand-alone use due to gas operation
- Device combines three functions into one:
 - Soldering iron, maximum temperature: 450 °C
 - Burner, maximum temperature: 1300 °C
 - Hot air blower, maximum temperature: 600 °C
- Small and easy to handle for working directly on the vehicle, for example
- Continuous gas regulation for optimum adaptation to the work to be carried out and the material
- Flame temperature maximum: 1300 °C
- Stand for stationary working conditions
- Piezo ignition
- Filling with commercial lighter / ISO butane gas
- Content:
 - Gas soldering iron
 - Soldering tip 3.5 mm
 - Soldering tip 4.5 mm
 - Heat-shrink tubing extension
 - Cutting tip
 - Soldering sponge protection cap
 - Solder wire



Improved solder tips



Fill level indicator



Gas valve



Stainless steel



Can be used flexibly everywhere with gas operation



V5488, EAN 4047728054881

Multifunctional drain pan · 50 l

- Used as a cleaning pan, dirt pan, oil pan, disinfection pan, leakage pan, transport pan and feed pan e.g. in sanitary and heating construction, the motor vehicle industry and workshops, for hunting equipment, chemical/laboratory use, food industry/butcheries, fishing, pet supplies, horse accessories, etc.
- Alkaline-resistant and acid-resistant

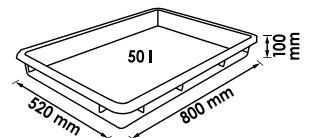

Universal application with huge capacity



V5677, EAN 4047728056779

Magnetic cup with plastic frame

- Two strong magnets for fixing to car lifts, tool trolleys, machinery, etc.
- Setting aside small magnetic and non-magnetic parts – free hands for work
- Plastic frame offers storage space for plastic screws etc. and also serves as a catch tray
- Small parts are stored so they are clearly visible and easy to find again

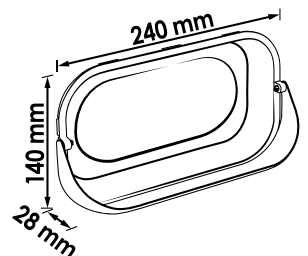

A little helper for great organisation



V5678, EAN 4047728070539

Magnetic half shell

- Holds screws, seals or small parts
- Fixation to tool trolleys, car lifts or metal cabinets
- For the workshop, production facilities or hobby room
- Solid plastic housing with optimised magnets
- Large opening for good view into the half shell
- Rubber housing on magnets prevents damage
- Magnetic cup magnetic on both sides – magnetic small parts adhere to back panel
- Additional stabilisation below the magnets for straight laying of the half shells
- Magnetic holding force: approx. 2.5 kg

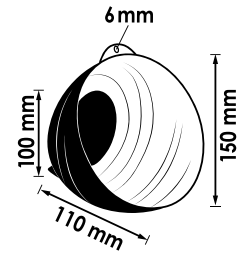

V6468, EAN 4047728064682

Nozzle adjusting tool with magnet

- Nozzle adjustment of windscreen washing systems
- Additional function as magnetic pick-up tool
- Pocket clip



Narrow insert pin \varnothing 0.6 mm

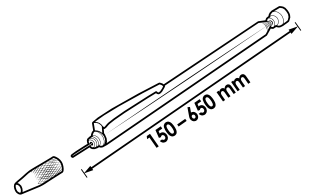

Including sales display
for a purchase of at least 16 pieces



V7221, EAN 4047728072212

Washing nozzle adjustment tool · MERCEDES-BENZ

- Damage-free adjustment of window washing system fan nozzles on MERCEDES-BENZ W204 · W207 · W212 · W218
- Optimal adjustment of window washing system fan nozzles on MERCEDES-BENZ
- Nozzle head profile with fitting accuracy
- Outside hexagon drive: 6 mm
- For the following models: W204 · W207 · W212 · W218
- Total length: 67 mm

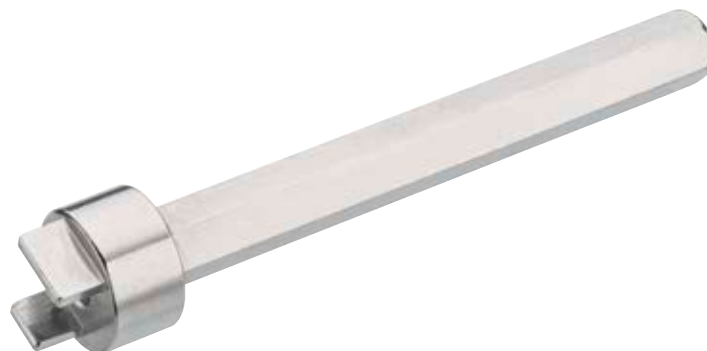

V6742, EAN 4047728067423

Magnetic tool holer

- Storage of impact sockets, impact wrenches, torque wrenches or hoses directly on site
- Strong magnets (each with \varnothing 80 mm) guarantee a good hold on car lifts, tool trolleys or other substructures containing iron
- Magnetic holding force: approx. 20 kg



Optimal storage of impact sockets and impact wrenches directly on site

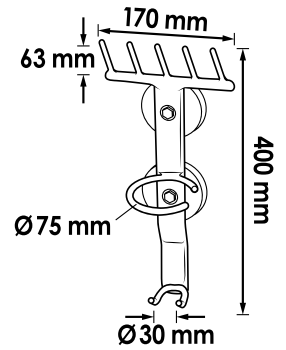

V6605, EAN 4047728066051

Fender cover

- Protection from dents, scratches, oil and dirt
- One size fits all
- Does not cover wheels

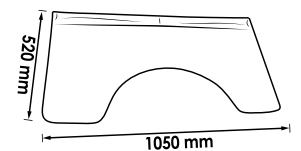

V6606, EAN 4047728066068

Reusable seat cover

- Protection of car seat against heavy soiling
- One size fits all, for most passenger cars and common commercial vehicles
- Light nylon, PU-coated
- Water, grease and oil repellent
- Contents: 1 piece
- Washable at 40°C

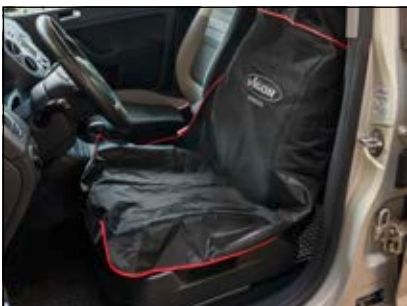

Dimensions:
L: 1350xW: 760 mm



Work gloves

- Assembly work in the workshop, warehouse / logistics and anywhere where secure grip and precision are important
- Light polyester woven gloves with ergonomic fit
- EN 388:2003 (3131A)



Black PU coating on the palms

VIGOR No.	Glove size	EAN 4047728+	
V6435	9 / L	064354	
V6435-XL	10 / XL	069984	

Gloves · Grip

- Protect hands from oil, grease, chemicals and dirt
- Surface structure provides good adhesion, even in oily working conditions
- Safety colour orange for better visibility in dark work spaces
- Comfortable, tear-resistant glove with good dexterity
- Touchscreen compatible
- Material: Nitrile
- Material thickness: 7 mil (corresponds to 0.18 mm)
- Latex and powder free



VIGOR No.	Glove size	EAN 4047728+	
V6436-M	8 / M	080118	
V6436-L	9 / L	077712	
V6436-XL	10 / XL	077729	
V6436-XXL	11 / XXL	077736	



V2338, EAN 4047728023382

Kneeling mat

- Comfortable working in the workshop, in industry, in the garden or in the household
- High-quality foam
- Knee-protecting
- Heat insulating
- Water and oil repellent
- With carrying handle

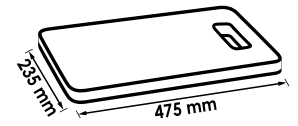

Comfortable and low-impact working in the workshop, in industry, in the garden or in the household



V6973, EAN 4047728069731

Mechanic's creeper

- Padded head rest
- Two side storage compartments for screws or other small parts
- High-quality finish made of plastic
- Easy to clean
- Six castors made of hard plastic
- Loading capacity maximum 150 kg

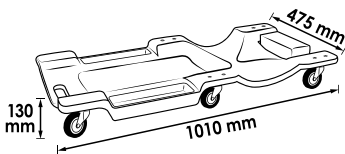

Work comfortably under vehicles



V6973-1, EAN 4047728069748

Replacement castor for mechanic's creeper



V4646, EAN 4047728**046466**

Brush set

- Professional cleaning and deburring of cylinders, tubes, bushings, etc.
- For drilling machines and pneumatic drills (When operating with power tools only use the brushes rotating clockwise)
 - 12 nylon brushes: Ø 8 · 9 · 10 · 11 · 12 · 13 · 14 · 15 · 16 · 17 · 18 · 19 mm
 - 12 steel brushes: Ø 8 · 9 · 10 · 11 · 12 · 13 · 14 · 15 · 16 · 17 · 18 · 19 mm
 - 12 brushes with brass coating: Ø 8 · 9 · 10 · 11 · 12 · 13 · 14 · 15 · 16 · 17 · 18 · 19 mm
 - 1 handle with adapter and quick lock
 - 1 extension 150 mm

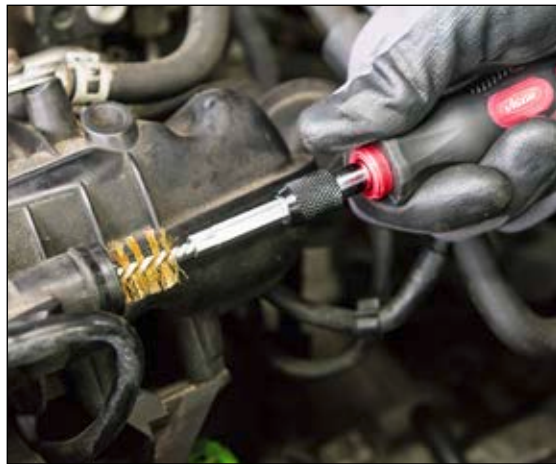

Spare parts 10 pieces per pack

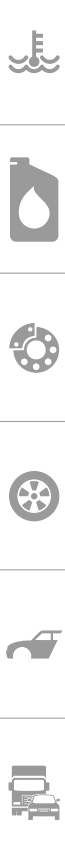

VIGOR No.	Designation	EAN 4047728+
V4646M-8	Brass brush set Ø 8 mm	054102
V4646M-9	Brass brush set Ø 9 mm	054119
V4646M-10	Brass brush set Ø 10 mm	054126
V4646M-11	Brass brush set Ø 11 mm	054133
V4646M-12	Brass brush set Ø 12 mm	054140
V4646M-13	Brass brush set Ø 13 mm	054157
V4646M-14	Brass brush set Ø 14 mm	054164
V4646M-15	Brass brush set Ø 15 mm	054171
V4646M-16	Brass brush set Ø 16 mm	054188
V4646M-17	Brass brush set Ø 17 mm	054195
V4646M-18	Brass brush set Ø 18 mm	054201
V4646M-19	Brass brush set Ø 19 mm	054218
V4646N-8	Nylon brush set Ø 8 mm	054225
V4646N-9	Nylon brush set Ø 9 mm	054232
V4646N-10	Nylon brush set Ø 10 mm	054249
V4646N-11	Nylon brush set Ø 11 mm	054256
V4646N-12	Nylon brush set Ø 12 mm	054263
V4646N-13	Nylon brush set Ø 13 mm	054270

VIGOR No.	Designation	EAN 4047728+
V4646N-14	Nylon brush set Ø 14 mm	054287
V4646N-15	Nylon brush set Ø 15 mm	054294
V4646N-16	Nylon brush set Ø 16 mm	054300
V4646N-17	Nylon brush set Ø 17 mm	054317
V4646N-18	Nylon brush set Ø 18 mm	054324
V4646N-19	Nylon brush set Ø 19 mm	054331
V4646S-8	Steel brush set Ø 8 mm	053587
V4646S-9	Steel brush set Ø 9 mm	053594
V4646S-10	Steel brush set Ø 10 mm	053600
V4646S-11	Steel brush set Ø 11 mm	054010
V4646S-12	Steel brush set Ø 12 mm	054027
V4646S-13	Steel brush set Ø 13 mm	054034
V4646S-14	Steel brush set Ø 14 mm	054041
V4646S-15	Steel brush set Ø 15 mm	054058
V4646S-16	Steel brush set Ø 16 mm	054065
V4646S-17	Steel brush set Ø 17 mm	054072
V4646S-18	Steel brush set Ø 18 mm	054089
V4646S-19	Steel brush set Ø 19 mm	054096

Flap disc set 115 mm

- High stock removal rate; allows effortless surface grinding on steel and stainless steel without smearing. Does not leave scratches on the workpiece
- Universal flap disc with long service life
- Contents: 10 pieces



VIGOR No.	XX	Outside Ø mm	Center hole mm	Grain size	1/min	EAN 4047728+
V6810-115K40	10	115	22.23	40	13280	067737
V6810-115K60	10	115	22.23	60	13280	067744
V6810-115K80	10	115	22.23	80	13280	067751

Flap disc set 125 mm

- High stock removal rate; allows effortless surface grinding on steel and stainless steel without smearing. Does not leave scratches on the workpiece
- Universal flap disc with long service life
- Contents: 10 pieces



VIGOR No.	XX	Outside Ø mm	Center hole mm	Grain size	1/min	EAN 4047728+
V6810-125K60	10	125	22.23	60	12200	067775
V7010-125K80	10	125	22.23	80	12200	070690

Cut-off wheel set

- Handheld cut-off wheels for stainless steel and steel for thin sheet metal (e.g. car body), steel cables, profiles, tubes, non-ferrous metals and high-temperature-resistant materials
- Particularly sharp disc with good service life



VIGOR No.	XX	Outside Ø mm	Center hole mm	Thickness mm	1/min	EAN 4047728+
V6811-115	10	115	22.23	1	13280	067287

Outside deburrer

- For deburring screws and threads and for adjusting deformed drive shafts, steering tie rods or stud bolts on wheel hubs
- Hexagon drive, 6.3 mm
- Rotation speed: 0 – 500 rpm
- Cutting plates made of high-strength tungsten steel
- Suitable for the following materials:
 - Stainless steel
 - Steel
 - Brass
 - Non-ferrous metal
 - Plastics

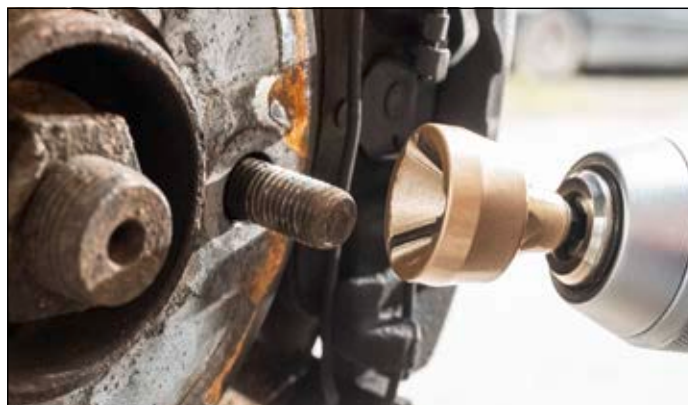
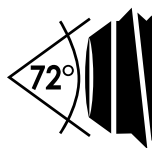

V7402

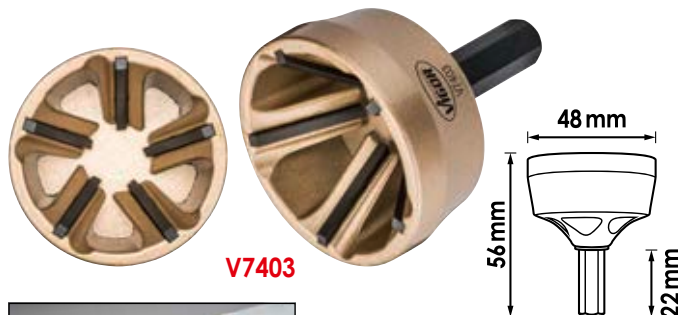

V7403



VIGOR No.	∅ mm	EAN 4047728+
V7402	3-19	074025
V7403	13-35	074032

V4638, EAN 4047728046381

Safety platform · aluminium

- Lightweight
- Safety locking on both feet
- Maximum loading capacity: 150 kg
- Weight: 7.2 kg



Space saving collapsible

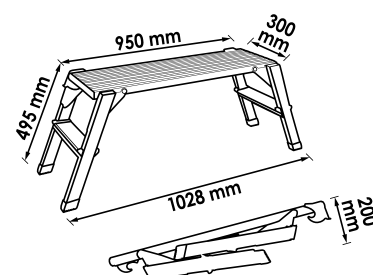



V5679M, EAN 4047728080637

Magnetic button set

- Attachment of, for example, order slips, notes and reminders to metallic surfaces
- Set consisting of 3 pieces
- Holding strength: 3 kg



NEW



V5680, EAN 4047728081436

Magnetic holder

- Universal attachment of objects and equipment, e.g.: compressed air hoses, cables, hearing protection, corded tools
- Rubberised magnet to protect the surface
- Holding strength: 18 kg



NEW



V5531, EAN 4047728055314

Single-hand mini window pane holder

- For lifting, carrying and holding
- Adjusting and setting mirror glass
- One-hand operation using lever
- Loading capacity maximum: 8 kg



With release button

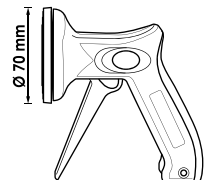



**Diagnostics / Battery /
Electrical System**

Video borescope	252
Flue gas leakage tester	253
Electrical system	254 256-257
Multimeter	254
Cable release tools	255
Crimping pliers set	256

V7501/2, EAN 4047728080255

Video borescope

- Analysis and documentation of damage patterns in difficult to access spaces
- Probe: Ø 4.9 mm
- Probe length: 1000 mm
- Camera resolution: 1280x720 pixels
- Camera viewing angle: 80°
- 6 dimmable LEDs
- Depth of field: 20 – 80 mm
- 5 inch display, swivelling
- Display resolution: 1280x720 pixels
- 6 Ah, 3.7 V Li-ion rechargeable battery
- Power supply unit 2 A · 5 V, USB charging cable and 32 GB Tf memory card included in delivery

NEW



1280 x 720 pixels



Flue gas leakage tester



V7524, EAN 4047728081320

Flue gas leakage tester

- Leakage detection in closed systems
- Leaks are quickly visualised through the application of flue gas
- Operation via the 12 V on-board power supply
- Pressurisation by means of „air“ mode and integrated manometer possible without further aids
- Smoke generation with suitable aid (vegetable glycerine or baby care oil)
- Universal application option thanks to various adapters
- Built-in air compressor
- Automatic safety shutdown in case of imminent overheating
- Infinitely adjustable air flow
- Diverse application possibilities, for example:
 - Intake and boost pressure system
 - Crankcase
 - Exhaust gas and exhaust gas recirculation system
 - Fuel system
 - Adblue and additive system
 - Tyres
 - Air conditioning system
 - EVAP fuel system (US vehicles)
 - Car body and glazing
 - (wind noise, moisture penetration, etc.)

NEW

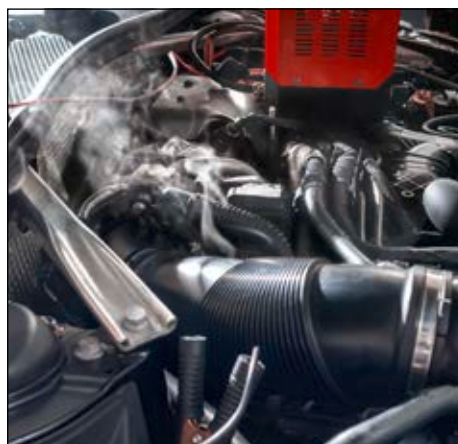
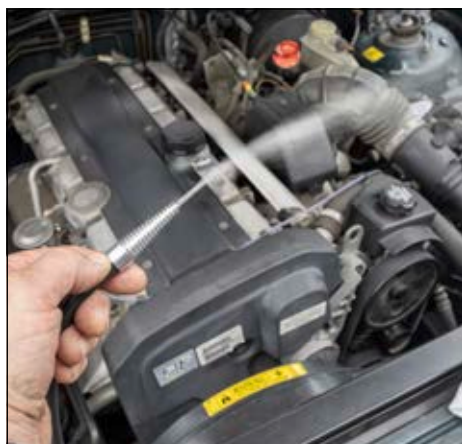

V4324, EAN 4047728**043243**

Digital multimeter

- Compact and practical
- High-contrast, one-line LCD display including backlighting
- 19-position rotary switch
- Reliable warning thanks to automatic overflow and polarity display for preventing possible errors
- Stand-up positioning including protective rubber cover
- Measuring cable with protection against contact
- DC: 200 mV – 600 V
- AC: 200 V – 600 V
- DC: 200 mA – 10 A
- Resistance: 200–2000 Ohm
- Diode tester
- Maximum display: 1999
- 9 V battery (in device)
- Fuses:
 - 1 x 250 mA / 250 V
 - 1 x 10 A / 250 V
- Multimeter for testing quiescent current
- Used with measuring cable set V4326
- Functions:
 - Direct and alternating voltage measurements
 - Direct and alternating current measurement
 - Resistance measurement
 - Diode test (with acoustic signal)
 - Passage inspection (with acoustic signal)
 - Data hold function



VIGOR No.	Designation	EAN 4047728+
V4324-1	Fuses · 5 pieces	053532
V4324-2	Measuring cable for V4324	053549

V1722, EAN 4047728**017220**

Car light tester

∠ 6 – 24 V

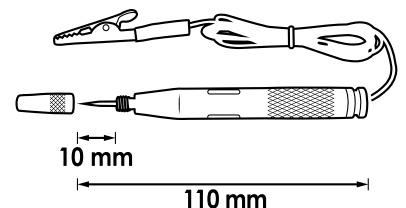
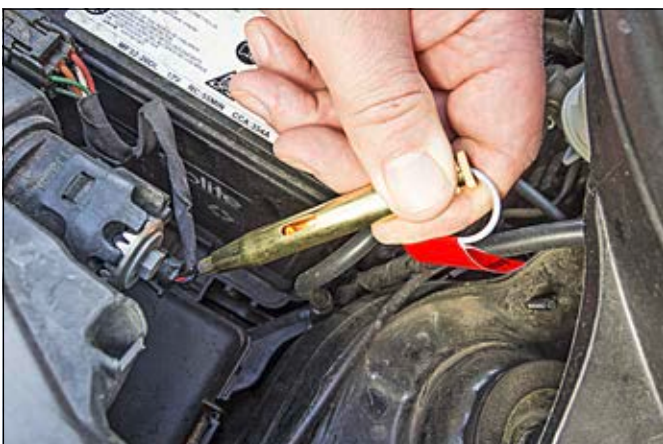

Cable release tools



V4451, EAN 4047728**044516**

Cable release tool set

- Damage-free release of electrical plugs and connectors e.g. with ABS, air conditioning sensors, radio, PDC, trailer coupling modules, etc.
- Fast trouble-shooting with corrosion or connection defects
- For round and flat connectors



Indispensable for mechatronics technicians and motor vehicle electricians

VIGOR No.	Designation	Design	EAN 4047728+
V4451-1	Individual cable release tool 1 · BMW · MERCEDES-BENZ · OPEL/VAUXHALL · VW/AUDI		053693
V4451-2	Individual cable release tool 2 · BMW · JAGUAR · MERCEDES-BENZ · PORSCHE · SAAB · SEAT · ŠKODA		053709
V4451-3	Individual cable release tool 3 · BMW · MERCEDES-BENZ · OPEL/VAUXHALL · PORSCHE · VW/AUDI		053716
V4451-4	Individual cable release tool 4 · FORD		053723
V4451-5	Individual cable release tool 5 · BMW · FORD · MERCEDES-BENZ · OPEL/VAUXHALL · PORSCHE · SEAT · ŠKODA · VW/AUDI		053730
V4451-6	Individual cable release tool 6 · BMW · FORD · JAGUAR · OPEL/VAUXHALL · MERCEDES-BENZ · PORSCHE · SAAB · SEAT · ŠKODA · VW/AUDI		053747
V4451-7	Individual cable release tool 7 · MERCEDES BENZ		053754
V4451-8	Individual cable release tool 8 · FORD · JAGUAR · MERCEDES-BENZ · OPEL/VAUXHALL · PORSCHE · VW/AUDI		053761
V4451-9	Individual cable release tool 9 · FORD · MERCEDES BENZ		053815
V4451-10	Individual cable release tool 10 · MERCEDES BENZ		053822
V4451-11	Individual cable release tool 11 · BMW · FORD · JAGUAR · MERCEDES-BENZ · OPEL/VAUXHALL · PORSCHE · SAAB · SEAT · ŠKODA · VW/AUDI		053839
V4451-12	Individual cable release tool 12 · OPEL/VAUXHALL · RENAULT · ŠKODA · VW/AUDI		053846
V4451-13	Individual cable release tool 13 · FORD · MERCEDES BENZ		053853
V4451-14	Individual cable release tool 14 · FORD · JAGUAR · PORSCHE		053860
V4451-15	Individual cable release tool 15 · BMW · FORD · MERCEDES-BENZ · OPEL/VAUXHALL · SEAT · ŠKODA · VW/AUDI		053877
V4451-16	Individual cable release tool 16 · BMW · FORD · JAGUAR · MERCEDES-BENZ · OPEL/VAUXHALL · PORSCHE · VW/AUDI		053884
V4451-17	Individual cable release tool 17 · BMW		053891
V4451-18	Individual cable release tool 18 · MERCEDES BENZ		053907
V4451-19	Individual cable release tool 19 · CITROËN · FIAT CHRYSLER · FORD · HONDA · MAZDA · OPEL/VAUXHALL · MERCEDES-BENZ · MITSUBISHI · PORSCHE · RENAULT · SEAT · TOYOTA · VW/AUDI		053914
V4451-20	Individual cable release tool 20 · FORD		053921
V4451-21	Individual cable release tool 21 · BMW · FORD · JAGUAR · MERCEDES-BENZ · OPEL/VAUXHALL · PORSCHE · SAAB · SEAT · ŠKODA · VW/AUDI		053938
V4451-22	Individual cable release tool 22 · HONDA · OPEL/VAUXHALL · TOYOTA · VW/AUDI		053945
V4451-23	Individual cable release tool 23 · OPEL/VAUXHALL · VW/AUDI		053952



V2499, EAN 4047728024990

Crimping pliers set

- Five replaceable crimping sockets:
- Crimping socket A: for insulated cable lugs from 0.5 – 6.0 mm² (red, blue, yellow)
- Crimping socket B: for closed, non-insulated cable lugs of 1.5 · 2.5 · 6.0 · 10 mm²
- Crimping socket C: for open, non-insulated cable lugs from 0.5 – 6.0 mm² (width up to 6.3 mm)
- Crimping socket D: for wire end sleeves with or without collar from 0.5 – 4.0 mm²
- Crimping socket F: for wire end sleeves above 6.0 mm²

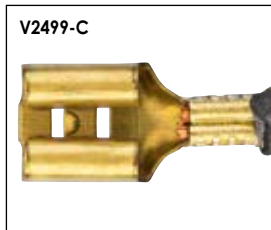

Spare parts

VIGOR No.	Designation	Design	EAN 4047728+
V2499-A	Crimping socket A: for insulated cable lugs from 0.5 – 6.0 mm ² (red · blue · yellow)		053440
V2499-B	Crimping socket B: for closed · non-insulated cable lugs of 1.5 · 2.5 · 6.0 · 10 mm ²		053457
V2499-C	Crimping socket C: for open · non-insulated cable lugs of 0.5 – 6.0 mm ² (width up to 6.3 mm)		053464
V2499-D	Crimping socket D: for wire end sleeves with or without collar from 0.5 – 4.0 mm ²		053471
V2499-F	Crimping socket F: for wire end sleeves above 6.0 mm ²		053488

V2499-A, EAN 4047728053440

Crimping jaws



V7548, EAN 4047728075480

Battery cell tester

- Check the status of battery and charging systems (12 and 24 V)
- Suitable for start-stop batteries
- For passenger cars, motorcycles, vans and boats
- Functions:
 - Status report of the battery and charging systems
 - Debit note when starting up the motor
 - Identification of defective batteries
 - Option to print the test results
- Mobile use, without power supply
- Makes it possible to check when fitted or removed
- User-friendly operation
- Reverse polarity protection prevents short circuit
- Thermal paper castor included in delivery
- Clamping cable length: 600 mm



V7548-1, EAN 4047728075527

Thermal paper castor

- Width: 56 mm
- Linear length: 5 m
- Diameter: 29 mm
- Sleeve diameter: 15 mm



V4326N, EAN 4047728079860

Measuring cable set

- Motor vehicle applications and 12 V batteries
- Measuring line adapters for simplifying fault diagnostics directly on the vehicle
- Polarity testers for testing hall sensor and photo sensors
- Measuring potentiometer for testing the temperature sensor and tank sensor
- Use with multimeter V4324
- 3 flat terminals, flat terminal sleeves, round terminals, pin-type cable connectors and pin-type cable sleeves



NEW



Engine / Radiator / A/C

Engine tools

259–262

Cooling system diagnostics

263–265

Turbo system diagnostics

266–267

Compression and pressure loss testers

268

Vacuum and pressure pump set

269

Injector sealing seat cleaning

270



V5676, EAN 4047728**056762**

Lambda probe set

- Lambda probes, injection nozzles as well as thermal circuit-breakers in hard to reach areas



● 22 mm



● 22 mm



● 27 mm

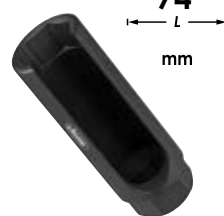

● 22 mm



● 29 mm



○ 27 mm



● 22 mm



V7002/4, EAN 4047728079815

Spark plug socket set

- Ball joints allow easy installation and removal in hard-to-reach places, e.g. on motorcycles or BMW N43 and N53 engines
- Magnetic
- Slim design
- Sizes: 14 · 16 · 18 · 20.8 mm
- For manual operation

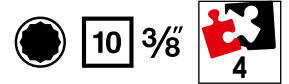

NEW

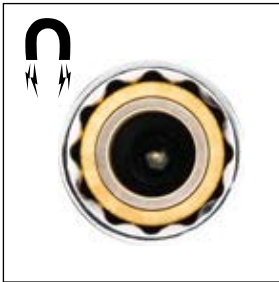

VIGOR No.	Designation	Design	■	Size	EAN 4047728+
V7002-14	Spark plug socket		10 3/8	14 mm	079822
V7002-16	Spark plug socket		10 3/8	16 mm	079839
V7002-18	Spark plug socket		10 3/8	18 mm	079846
V7002-20.8	Spark plug socket		10 3/8	20.8 mm	079853



V6741, EAN 4047728067416

Extractor set for ignition coils

- Professional and damage-free removal of ignition coils and ignition coil strips on VAG and OPEL/VAUXHALL engines
- Attaching and then removing enables an even disassembly of the ignition module
- Recommended use in pairs
- Greatest market coverage
- 2 ignition module pullers for:
 - CHEVROLET/GMC Aveo Cruze · OPEL/VAUXHALL Adam · Agila B · Astra J · Cascada Combo · Corsa D · Meriva B · Mokka · Zafira Tourer
 - Engines:
 - 1 litre A10XEP (LDB), 1.2: A12XEL (LWD) A12XER (LDC), 1.4: A14XEL (L2Z) A14XER (LDD) LDU
 - 1.4 litres (T) A14NEL (LUH) A14NET (LUJ) Twinport / ecoFLEX engines
 - OPEL 3 or 4-cylinder petrol injection engines e.g. in Agila A · Astra F · Astra G · Astra H · Astra J · Calibra Combo · Corsa B · Corsa C · Corsa D · Frontera A · Frontera B · Insignia · Meriva A · Meriva B · Omega B · Signum · Tigra A · Tigra B · Vectra B · Vectra C · Zafira A · Zafira B
 - Engine codes: 20LEH · 2HO · A10XEP · A14NEL · A14NET · A14XER · A16LET · A16XER · A18XER · C22SEL · LDD · LDE · LLU · LUH · LUJ · X14NZ · X14SZ · X14XE · X16SZR · X16XE · X16XEL · X18XE · X20SE · X20XEV · X22SE · X22XE · Y22SE · Z10XEP · Z12XE · Z12XEP · Z14XE · Z14XEL · Z14XEP · Z16LEL · Z16LER · Z16LET · Z16XE · Z16XER · Z16YNG · Z18XE · Z18XER · Z20LER
- 4 ignition claws:
 - TYPE A (26 mm): e.g. VW Golf · Bora · Beetle · Lupo · Passat · Touran · T4 · AUDI A2
 - TYPE B (18 mm): Bora · Golf · Passat · Sharan · Touareg · Phaeton · T5
 - TYPE C (43 mm): 8 and 12-cylinder engines such as Phaeton, among others
 - TYPE D (35 mm): Direct injection engine VW Golf · Touran · Passat and Eos as well as AUDI A4 and A6



V6740, EAN 4047728077774

Extractor set for ignition coils · VAG

- Safe and damage-free removal of ignition coils with final output stage according to manufacturer's specifications, e.g. on 1.0 I / 1.0 I TSI / TFSI / TGI / GTI / CNG - 1.0 I · 1.0 I TSI · TFSI · TGI · GTI · CNG · 1.2 I TSI · 1.4 I · 25 · 30 · 35 · 40 · 45 TSI · TFSI · TGI · CNG · GTE · Mild Hybrid · e-Hybrid · 1.6 I · 1.6 I SRE · MPI 2.0 I GTI
- Engines among others installed in the following models: AUDI A1 · A3 · A4 · A5 · Q2 · Q3 SEAT Alhambra · Arona · Ateca · Cupra Formentor · Ibiza · León · Mii · Tarraco · Toledo ŠKODA Citigo · Fabia · Kamiq · Karoq · Kodiaq · Octavia · Rapid · Scala · Super · Yeti VW Arteon · Beetle · Caddy · Golf 6-8 · Jetta 4-7 · CC · Passat B8 · Polo 5-6 · Scirocco · Sharan · T7 · Taigo · Tiguan · Touran · T-Cross · T-Roc · Up!
- Removal of both ignition coil versions possible:
 - 04C.905.110.J model year →2017
 - 04E.905.110.K model year 2017→

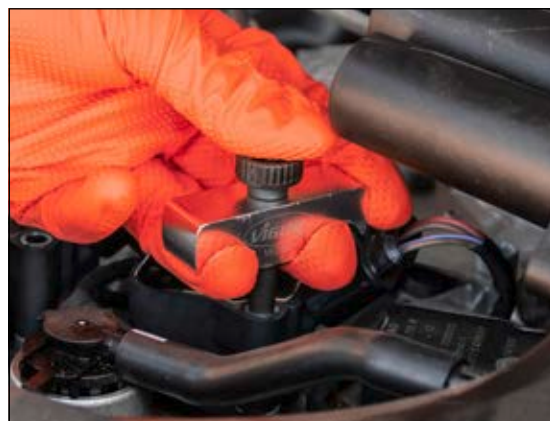

V3381, EAN 4047728033817

Hose clamp set

- For hoses with Ø up to 45 mm



V3571, EAN 4047728035712

V-ribbed belt tool

- Fibre-glass reinforced nylon
- Most easy-to-use tool on the market
- No adjustment necessary
- For all flexible belts: air-conditioning systems, generators, and single/double pulleys



Installation



Removal



V5660, EAN 4047728056601

Coupling element from 4.4 mm to 7.2 mm

- Adaptation of hand pump V3729 with products from other manufacturers, e.g. Klann adapters / systems (4.4 mm to 7.2 mm)



V5922, EAN 4047728059220

Coupling element from 7.2 mm to 4.4 mm

- Adaptation of VIGOR cooling system adapter with e.g. Klann hand pumps / systems (7.2 mm to 4.4 mm)



V2459N, EAN 4047728075541

Refractometer

- Fast, precise control of the anti-freeze concentration on coolant and screenwash as well as for checking the battery acid density and AdBlue
- Eyepiece with adjustable focus, equipped with rubber cup
- Left scale: battery acid density measuring range 1100 – 1400 sg / resolution 0.01 sg
- Middle scale: antifreeze based on propylene glycol G 13, measuring range 0°C to -50°C / resolution 5° C, and antifreeze based on ethylene glycol G 11/G 12, measuring range 0°C to -50°C / resolution 5°C
- Upper right scale: AdBlue (VRA) urea concentration, measuring range 30% – 35% / resolution 0.1%
- Lower right scale: screenwash antifreeze SRF 1, measuring range 10°C to -40°C / resolution 1°C
- Plastic case with soft foam insert
- Contents:
 - 1 x refractometer
 - 1 x pipette



Application e.g. for coolant, screenwash, battery fluid and AdBlue



V1963/28, EAN 4047728081467

Cooling system diagnosis set

- Passenger car diagnostics
- New adapter series with approx. 20 % space saving per adapter
- VIGOR cooling system system lids build up approx. 20 % less height than comparable products on the market
- Comfortable and efficient work, by reaching almost all expansion tanks
- Greatest market coverage
- Including adapter no. 23 for common vehicle models such as AUDI A3 · A4 · VW Golf · Passat · Polo
- Complete set for service work on the cooling system and heating circuit
- Comprehensive range of adapters for vehicles with water-cooled engines
- 3 features: pressure test (check for leaks in radiator system) · filling · cleaning
- Control of pressure loss via manometer
- Filling creates a vacuum in the radiator system (Advantage: coolant is sucked in without air bubbles)
- Enables filling of even large engines without thermal influences
- Universal usage due to conical rubber radiator adapter
- Measuring range: 0–2.5 bar



VIGOR No.	Designation	Design	EAN 4047728+
V1963N-6	Cooling system diagnostics adapter		082044
V1963N-8	Cooling system diagnostics adapter		082051
V1963N-9	Cooling system diagnostics adapter		082068
V1963N-A	Cooling system diagnostics adapter		082082
V1963N-B	Cooling system diagnostics adapter		082136
V1963N-C	Cooling system diagnostics adapter		082099
V1963N-E	Cooling system diagnostics adapter		082129
V1963N-F	Cooling system diagnostics adapter		082112
V1963N-G	Cooling system diagnostics adapter		082167
V1963N-H	Cooling system diagnostics adapter M32x2.0		082181
V1963N-M	Cooling system diagnostics adapter		082105
V1963N-R	Cooling system diagnostics adapter		082174

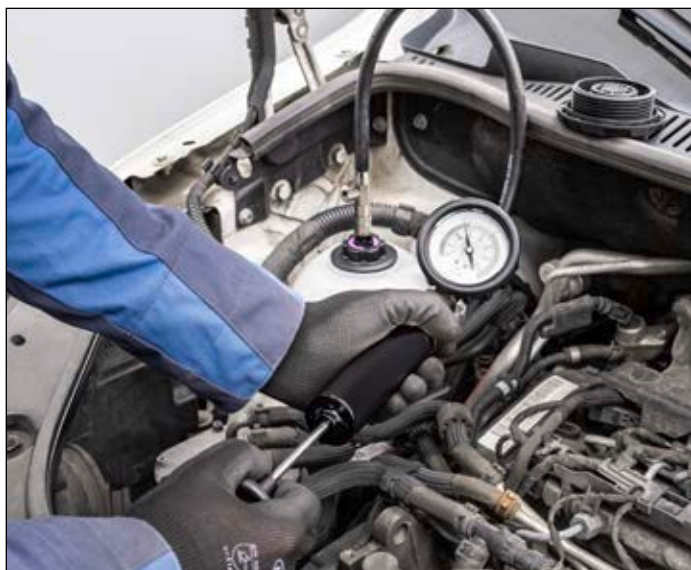

NEW

28



**Largest model coverage
on the market!**
Compatible with hybrid vehicles

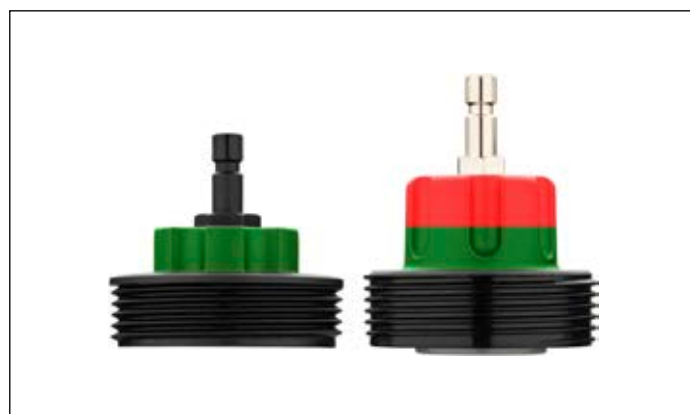

VIGOR No.	Designation	Design	EAN 4047728+
V1963N-S	Cooling system diagnostics adapter		082143
V1963N-T	Cooling system diagnostics adapter		082150
V1963N-X	Cooling system diagnostics adapter M55x2.5		082198
V1963-3	Test adapter black R123 · R124		053242
V1963-4	Test adapter blue R123 · R125		053259
V1963-5	Bayonet adapter · Ø 38 mm		053266
V1963-6	Bayonet adapter · Ø 42 mm		053273
V1963-7	Bayonet adapter · Ø 50 mm		053280
V3729	Hand pump with manometer		037297
V4202	Vacuum filling unit		042024
V1963-22	Thermometer		053433
V1963-25	Universal adapter / tapered head		060127

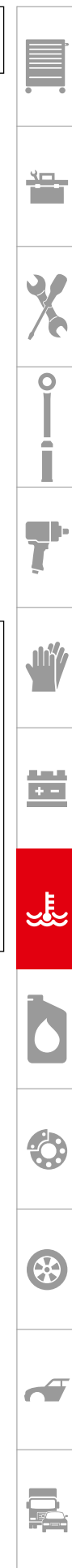

V4192, EAN 4047728**041928**

Turbo system pressure tester set for click systems

- Quick diagnosis of charging air systems in new generations of vehicles in which air pipes are connected with click systems
- Performing leak tests using noise generation, leak detector spray or pressure drop
- Contents: 6 plug pairs 31 · 38 · 46 · 51 · 56 · 61 mm



Without manometer

Enables time saving and appropriate determination of leaking charging air hoses



V4233, EAN 4047728**042338**

Manometer for turbo system pressure tester set

For V3595 · V4192 and V4331



V4304, EAN 4047728043045

Turbo system pressure tester set for motor vehicles

- Fast diagnostics of the charging air system
- Proper, time-saving identification of leaky charge-air coolers and invisible cracks in charging air hoses
- Contents:
 - 1 pressure hose with manometer and equalization valve
 - 6 pairs of stepped adapters:
 - 31/38 · 46/51 · 55/60 · 65/70 · 75/80 · 85/90 mm



Including manometer



V4305, EAN 4047728043052

Adapter 31/38 mm

- Use with manometer V4233 for testing the turbo system
- For example as an extension to the turbo system pressure tester set V3595



V4306, EAN 4047728043069

Adapter 46/51 mm

- Use with manometer V4233 for testing the turbo system
- For example as an extension to the turbo system pressure tester set V3595



V4461, EAN 4047728044615

Compression and pressure loss tester set

- Professional testing of compression and pressure loss for the engines of most of passenger cars, trucks, motorcycles, buses, agricultural vehicles and boats as well as Hdi, TDCi and pump injector engines
- For diesel and petrol engines
- Contains glow plug adapter for e.g.: ALFA ROMEO · BMW · CHRYSLER · DAEWOO · FIAT · FORD · HYUNDAI · ISUZU · LAND ROVER · MAZDA · MERCEDES-BENZ · MITSUBISHI · NISSAN · OPEL · PSA · RENAULT · SAAB · SUZUKI · TOYOTA · VAG · VAUXHALL · Volvo · etc.
- Glow plug adapter M 10 · M 12 · M 14 · M 18
- Compression pressure gauge maximum 50 bar
- Quick coupler in straight and angled design
- Injector nozzle adapter M 20 · M 22 · M 24 and for FORD Stanadyne injectors

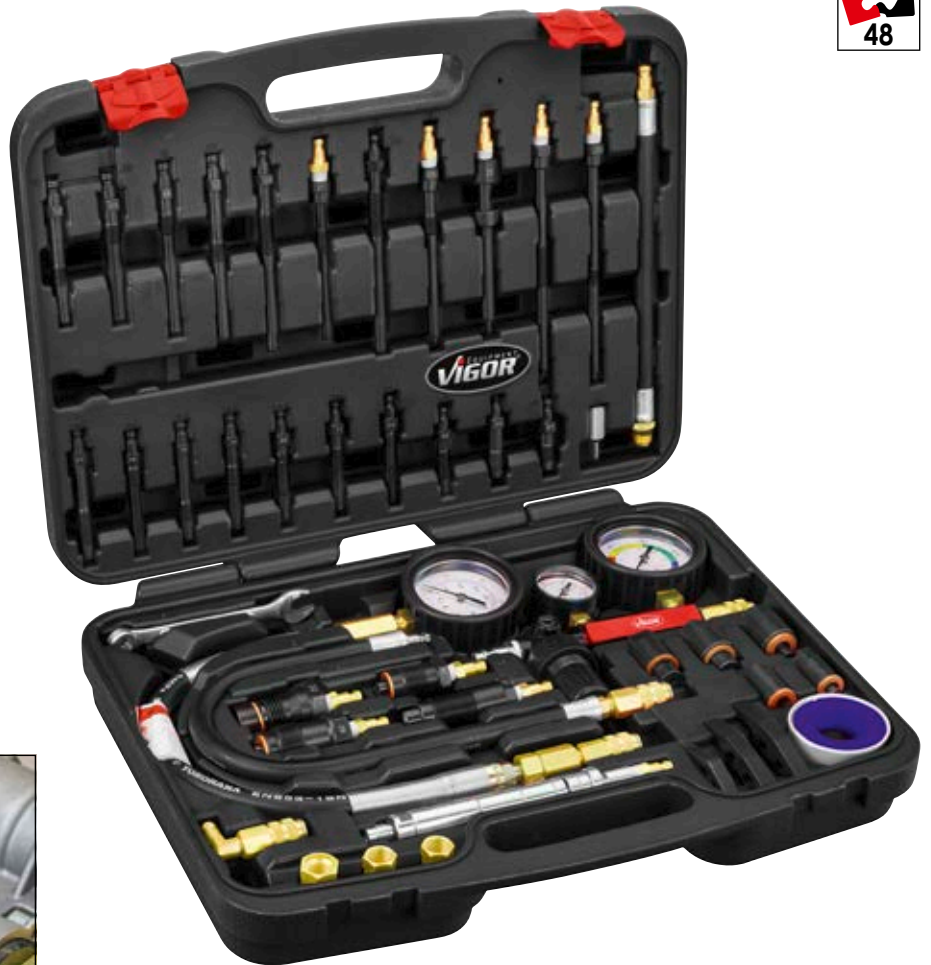

For diesel and petrol engines

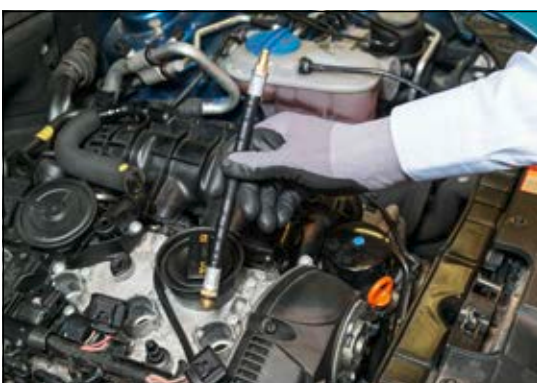

Vacuum and pressure pump set



V4325, EAN 4047728**043250**

Vacuum and pressure pump set

- Testing pressure and underpressure systems
- Charging pressure
- Vacuum solenoids
- MAP sensors
- Tank aerations
- Brake line systems
- Including extensive assortment of adapters



Also suitable for brake line systems



Hose length: 630 m



Filling capacity:
120 ml



Robust metal design

Display range: -1 to 4 bar
Underpressure indicator range: from -1 to 0 bar

Maximum pressure: up to 3 bar
Maximum underpressure: up to 0.7 bar



V4941N, EAN 4047728077293

Injector sealing seat cleaning set

- Eliminating soot residues, particles on HDI, diesel direct injection and common rail engines with Bosch and Delphi injectors
- Including sealing plug for protection against combustion chamber contamination
- Centring crowns for accurate guiding



Proper cleaning of the injector sealing seat, injector tip and pintle opening

VIGOR No.	Designation	Design	mm	EAN 4047728+
V4941N-1	Sealing ring spreader		265	077415
V4941N-2	Reamer		225	077422
V4941N-3	Cutter head holder - long - knurled handle		255	077439
V4941N-4	Adapter - flexible		225	077446
V4941N-5	Cutter head holder - short		175	077453
V4941N-M5	Protection cap - M5		15	077460
V4941N-BL	Cleaning brush - long		300	077576
V4941N-BK	Cleaning brush - short		85	077569
V4941N-19T	Hexagon - T handle - 19 mm		155	077521
V4941N-10	Holder for protection cap - M5		200	077477
V4941N-11	Holder for cleaning brush		90	077514
V4941N-245	Adapter - Ø 24.5 mm		32.8	077552
V4941N-20	Adapter - Ø 20 mm		32	077538
V4941N-22	Adapter - Ø 22 mm		32.8	077545

VIGOR No.	Designation	Design	mm	EAN 4047728+
V4941N-R1	Cutter - 120 degrees - 15.5x15.5 mm		38	077583
V4941N-R2	Cutter - 90 degrees - 15.5x15.5 mm		38	077590
V4941N-R3	Cutter - 90 degrees - 14x14 mm		38	077606
V4941N-R4	Cutter - 90 degrees - 19x21.5 mm hexagon		38	077613
V4941N-R5	Cutter - 120 degrees - 17x21 mm		38	077620
V4941N-R6	Cutter - 90 degrees - 17x20 mm		38	077637
V4941N-R7	Cutter - 120 degrees - 17.5x20.5 mm		38	077644
V4941N-R8	Cutter - 90 degrees - 17x19.5 mm		38	077651
V4941N-R9	Cutter - 90 degrees - 17x19 mm		38	077668
V4941N-R10	Cutter - 90 degrees - 15x19 mm		38	077675
V4941N-R11	Cutter - 90 degrees - 17x17.5 mm		38	077682
V4941N-R12	Cutter - 120 degrees - 17x17 mm		38	077699
V4941N-R13	Cutter - 90 degrees - 17x17 mm		38	077705



Oil service



Oil dipsticks

272

Oil filter tensioner adjusters

273–274

Oil pumps and filling devices

275–276

V5048, EAN 4047728**050487**

Tank sensor key · universal

- Operation of locking on tank sensor
- For areas with restricted access

Proper and time-saving working without damaging the lock ring

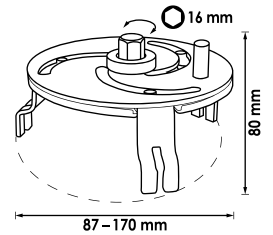

V2112, EAN 4047728**021128**

Oil dipstick set MERCEDES-BENZ

- Measuring the level of engine and automatic gearbox oil
- Essential after each oil change (vehicle provided by the manufacturer without dipstick, only with sealing plug)

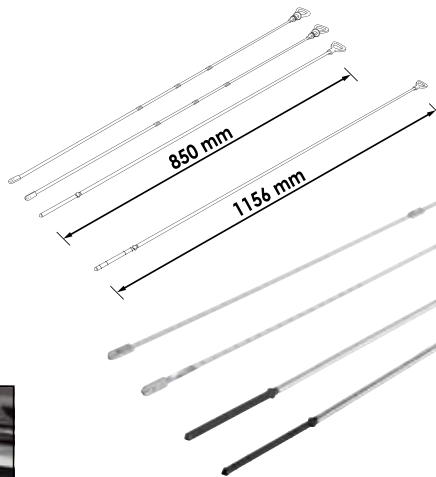

Manual



Automatic



V2645, EAN 4047728**026451**

Oil dipstick AUDI

- Check the level after oil change and subsequent comparison with the display
- For models with oil level indicator on the display (no dipstick in the engine)
- Helpful after replacing the oil sensor or calibrating the indicator in the driver's display (comparable to T40178)
- Application: for AUDI A4 / A5 / A6 with engines 1.8 · 2.0 TFSI / 3.0 · 3.2 FSI / 2.0 · 2.7 · 3.0 TDI, among others

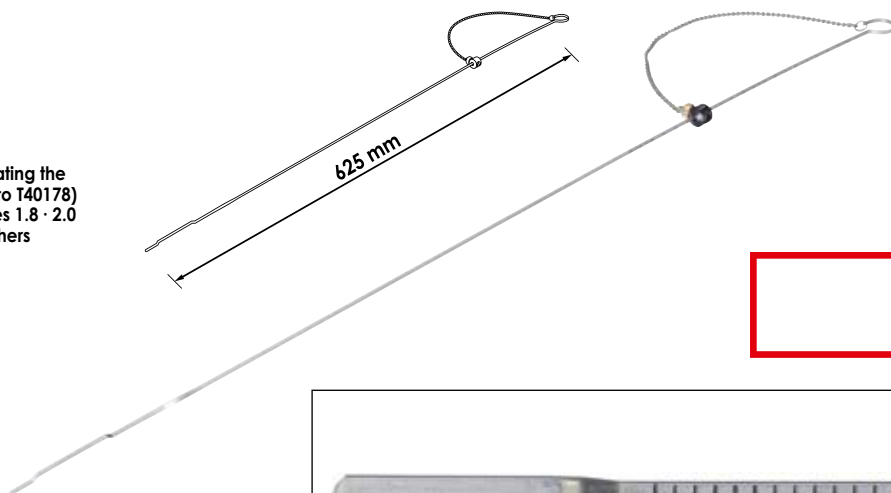

Oil filter tensioner adjusters



V2511N, EAN 4047728068239

Oil filter strap wrench

- Installation and removal of oil filters
- Infinitely adjustable
- Setting to filter Ø by turning on the end of the handle
- Ergonomic handle

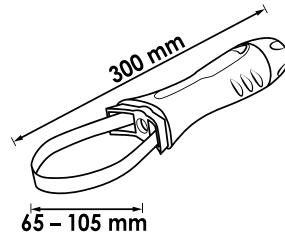
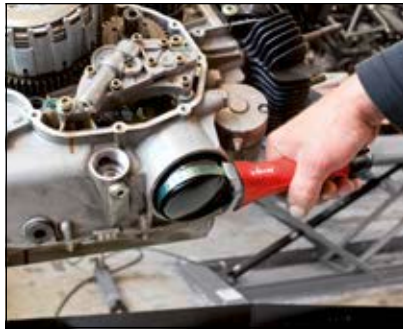

V2521, EAN 4047728025218

Spare strap

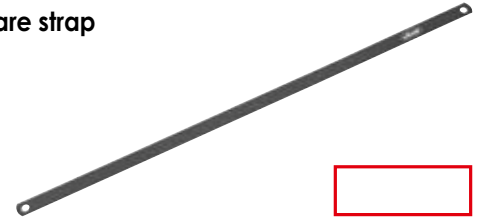

V1281, EAN 4047728012812

Oil filter claw wrench

- Optional drive: 1/2" inside square or size 21 mm outside hexagon

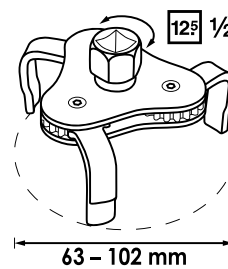

V7385, EAN 4047728077194

Gearbox tool set · MERCEDES-BENZ · 9-speed Tronic

- Draining and filling the gearbox oil on 9-speed Tronic automatic transmission with identification 725 (725589029000 · 725589009000)
- All necessary tools for oil change
- Drain wrench for adjusting the standpipe
- Contents:
 - Oil filter adapter (use with oil filling device V4385N)
 - Multifunction oil drain wrench
 - Oil drain plug wrench



Oil filter tensioner adjuster · universal

- Mechanical locking of the oil filter wrench simplifies subsequent attachment of the reversible ratchet to the oil filter wrench
- The oil filter tensioner adjuster always remains under tension when the reversible ratchet is moved backwards
- Infinitely adjustable
- Use with wrench size 21 mm or $\frac{11}{16}$ reversible ratchet
- Optimal hold when loosening the oil filter thanks to left-toothed jaws
- For oil filters in areas with restricted access
- Clockwise/anti-clockwise application enables operation of the screw connection

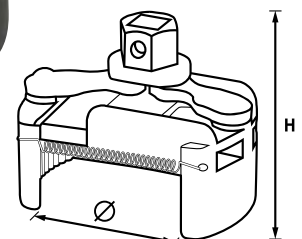

Continuous interlinking



VIGOR No.	Height	■	Ø mm	EAN 4047728+
V4413	60	● 21 mm, $\frac{11}{16}$	60-80	044134
V4414	70	● 22 mm, $\frac{11}{16}$	80-115	044141
V4415	105	● 24 mm, $\frac{11}{16}$	115-140	062114

V4701, EAN 4047728**073844**

Mini vacuum pump

- Manual vacuum pump for extracting and filling vehicle fluids
- Fill level display is nice and clear
- Accurate dosage and easy handling thanks to ergonomic design
- Capacity: 100 ml
- Including rubber tubing with stop cap to prevent leakage
- For the following liquids:
 - Diesel fuels
 - Petrol
 - Brake fluid
 - Antifreeze
 - Engine oil
 - Transmission oil
 - Power steering oil

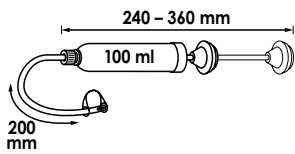

V4369, EAN 4047728**043694**

Vacuum pump

- Suction intake and decanting of fuels, oils and other liquids
- Capacity: 350 ml
- For the following liquids among others:
 - Diesel fuels
 - Petrol
 - Brake fluid
 - Antifreeze
 - Engine oil
 - Transmission oil
 - Power steering oil
- Contents:
 - 1 x hand pump 350 ml
 - 1 x PVC hose \varnothing 9.8 x 300 mm
 - 1 x silicone hose \varnothing 11 x 300 mm
 - 1 x drip plug
 - 1 x universal adapter

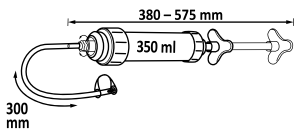

V4201, EAN 4047728**042017**

Vacuum pump

- Manual vacuum pump for extracting and filling vehicle fluids
- Pre-filling the fuel filter in vehicles without a pre-filter pump, e.g. the 2.0 I TDI FORD Galaxy and Mondeo
- Capacity: 1.5 l
- For the following liquids:
 - Diesel fuels
 - Petrol
 - Brake fluid
 - Antifreeze
 - Engine oil
 - Transmission oil
 - Power steering oil

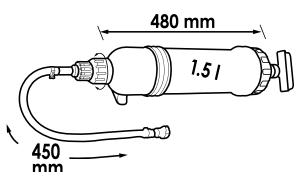

Suitable for all fuel types



V4201-1, EAN 4047728**056588**

Gasket set for V4201



V4385N, EAN 4047728072601

Oil filling device with adapter set

- Filling gearboxes and differentials with oil
- Incl. oil pan and 16 adapters for vehicles with limited installation space
- Filling hose 1.5 m

New improved set content



VIGOR No.	Designation	Design	EAN 4047728+
V3681	Adapter FORD · with threaded connection		036818
V3682	Adapter BMW · bent		036825
V3683	Adapter VAG · short · bent		036832
V3684	Adapter VAG · long · bent		036849
V3685	Adapter VAG · straight · with threaded connection		036856
V3686	Adapter MERCEDES-BENZ · 7-speed automatic		036863
V3687	Adapter VAG · DSG direct shift gearbox		036870
V3688	Adapter VAG CVT · continuously variable transmission		036887
V3689	Adapter Volvo · straight		036894
V3690	Adapter ŠKODA · M 18x 1.5 mm		036900
V3691	Adapter VW · Passat		036917
V4113	Adapter TOYOTA · LEXUS · 18x 1.5		041133
V4114	Adapter Infiniti · 7 speed M 8x 1.0		041140
V4115	Multifunction adapter		041157
V4383	Adapter NISSAN · Juke M 12x 1.25 mm		043830
V4384	Adapter MINI Cooper · M 14x 1.5 mm		043847
V7285	Adapter NISSAN · Hybrid · M 10x 1.5		072854
V7286	Adapter GM · M 12x 1.75		072861
V7287	Adapter ŠKODA · M 18x 1.5		072878
V7288	Adapter VAG · 7-speed dual clutch		072885





Brakes

Brake maintenance and bleeding

278–280

Brake piston readjusting tools

281–284

Brake disc tools

285–286

Tube flaring tools

287–289

Inspection tools

290–294





V4411, EAN 4047728044110

Brake bleeder set 3 l · manual

- Bleeding brake and coupling systems
- Working pressure: max. 1.4 bar
- Manometer range: 0 – 2 bar
- Draining of the pressure through integrated pressure relief valve
- Contents:
 - 3 litre tank
 - E20 Euro adapter
 - Universal adapter with chain
 - Connecting hose with quick connection
 - Collection tank with connection nipple for brake systems

Especially suited for mobile use with manual pressure build-up function



Capacity: 3 litres



V4668, EAN 4047728046688

Brake fluid tank

- Collection tank for bleeding brake and coupling systems
- Silicone tube, length: 550 mm
- Contents of V4411

Suitable for all common bleeding valves



Capacity: 0.7 litres



V4381, EAN 4047728**043816**

Adapter for brake service systems

- Together with conventional brake service devices
- Cover made from durable aluminium
- Contents:
 - Adapter E 20 W for expansion tanks with restricted access, for almost all European vehicles
 - Adapter G 75 for ISUZU · MITSUBISHI · PROTON · SUBARU · SUZUKI · Volvo · KIA
 - Adapter B 35 for CHRYSLER · FORD · NISSAN · SUBARU · HYUNDAI
 - Universal adapter with chain mounting

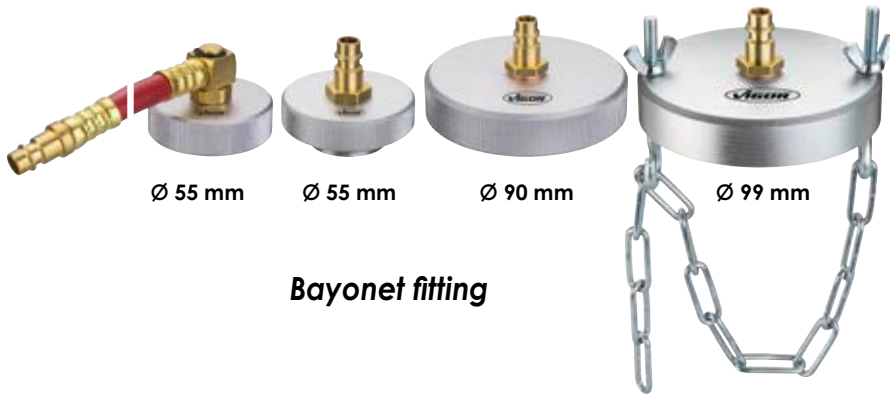

Ø 55 mm

Ø 55 mm

Ø 90 mm

Ø 99 mm

Bayonet fitting

Simple and useful supplement for using service devices on almost all vehicles

VIGOR No.	Designation	Design	EAN 4047728+
V4381-1	Adapter E 20 W for brake service systems		046930
V4381-2	Adapter G 75 for brake service systems		046947
V4381-3	Adapter B 35 for brake service systems		046954
V4381-4	Universal adapter with chain mounting for brake service systems		046961



V7471, EAN 4047728074711

Brake bleeding set

- Bleeding brake line systems, changing brake fluids without removing the wheels
Also for bleeding coupling systems
- Comfortable application thanks to ergonomic special ratchet
- Easy opening and closing of the brake nipple thanks to special hinge ratchet
- Guarantees fast access to the brake nipple even with the wheel mounted
- Good power transmission due to application-optimised handle
- Angle coupling piece in 90° design with back pressure valve and anti-rotation protection
- Back pressure valve protects system against ingress of air



10 – 11 mm



Optional accessories (not included in delivery)

VIGOR No.	Designation	Design	Size	EAN 4047728+
V7471-A	90° Universal adapter		-	074889
V7471-T	Silicon hose		-	074896
V7471-TL	Rubber hose · long		-	074865
V7471-TS	Rubber hose · short		-	074858
V7471-W	Brake bleeding ratchet 14 mm hexagon		-	074872
V7471L-10	Socket · long · 10 mm		10 mm	074834
V7471L-11	Socket · long · 11 mm		11 mm	074827
V7471S-10	Socket · short · 10 mm		10 mm	074759
V7471S-11	Socket · short · 11 mm		11 mm	074766

VIGOR No.	Designation	Design	Size	EAN 4047728+
V7471S-7	Socket · short · 7 mm		7 mm	074728
V7471S-8	Socket · short · 8 mm		8 mm	074735
V7471S-9	Socket · short · 9 mm		9 mm	074742
V7471S-12	Socket · short · 12 mm		12 mm	074773
V7471L-7	Socket · long · 7 mm		7 mm	074780
V7471L-8	Socket · long · 8 mm		8 mm	074797
V7471L-9	Socket · long · 9 mm		9 mm	074803
V7471L-12	Socket · long · 12 mm		12 mm	074841

V7471/17, EAN 4047728077187

Complete brake bleeding set

- Bleeding brake line systems, changing brake fluids without removing the wheels
Also for bleeding coupling systems
- Comfortable application thanks to ergonomic special ratchet
- Easy opening and closing of the brake nipple thanks to special hinge ratchet
- Guarantees fast access to the brake nipple even with the wheel mounted
- Good power transmission due to application-optimised handle
- Angle coupling piece in 90° design with back pressure valve and anti-rotation protection
- Back pressure valve protects system against ingress of air
- Nut-driver: size 7 – 12 mm in short and long designs included in delivery



7 – 12 mm



Brake piston readjusting tools



V1711N, EAN 4047728060738

Brake piston readjusting tool set · pneumatic

- Pushing and turning of brake pistons on nearly all passenger cars
- Efficient, damage-free working on brake systems
- For clockwise and anti-clockwise brake pistons
- Makes controlled rewinding by hand possible, in addition to pneumatic support
- Quick-connectors allow adapters to be mounted easily
- Automatic balancing of different thread pitches
- Set with 23 pieces: 1 pneumatic spindle · 22 adapter plates



Now even greater market coverage



V1711-1, EAN 4047728067331

Brake piston readjusting tool · pneumatic

- For right- and left-hand threads
- Protects against damage to sleeve gaskets
- Makes simultaneous operation and turning possible
- Magnet on the socket ensures the adapter is secure



V3760N, EAN 4047728066310

Brake piston readjusting tool set

- Clockwise and anti-clockwise brake pistons
- Including 4 special sockets
- Reset by pressing and simultaneously turning the brake piston
- Numbering of the adapter plates for detailed assignment
- Magnetic spindle sockets for comfortable work
- Contents:
 - 2 spindles (anti-clockwise and clockwise)
 - 2 hex-head wrenches (6 and 7 mm)
 - 2 drift pins
 - 3 exchangeable reaction plates
 - 36 reaction plates and adapters
 - 4 special brake fitting sockets
 - 1 spindle grease
- Adapters enable use even on very worn brake linings and assembly of the back plate in the break calliper



VIGOR No.	Designation	Design	■	∅	Pin diameter	Pin height	Size	EAN 4047728+
V3760-1	Adapter plate 1		-	-	-	-	-	067164
V3760-2	Adapter plate 2		-	51	6	9	-	066853
V3760-3	Adapter plate 3		-	55	-	-	-	067201
V3760-4	Adapter plate 4		-	32	5	2.5	-	066631
V3760-5	Adapter plate 5		-	36	6	4	-	066648
V3760-6	Adapter plate 6		-	42	6	4	-	066655
V3760-7	Adapter plate 7		-	42	6	2	-	066662
V3760-11	Adapter plate 11		-	-	-	-	-	066679
V3760-12	Adapter plate 12		-	-	-	-	-	066686
V3760-A	Adapter plate A		-	41	6	4	-	066693
V3760-B	Adapter plate B		-	38	10	3	-	066709
V3760-C	Adapter plate C		-	38	4	3	-	066716
V3760-D	Adapter plate D		-	51	6	3	-	066723
V3760-E	Adapter plate E		-	42	5	3	-	066730
V3760-F	Adapter plate F		-	36	6	4	-	066747
V3760-G	Adapter plate G		-	32	4	3	-	066754
V3760-J	Adapter plate J		-	44	6	3	-	066761

Brake piston readjusting tools



VIGOR No.	Designation	Design	■	∅	Pin diameter	Pin height	Size	EAN 4047728+
V3760-K1	Adapter plate K1		-	54	10	7	-	066778
V3760-K2	Adapter plate K2		-	45	6	4	-	066785
V3760-M	Adapter plate M		-	32	6	3	-	066792
V3760-P	Adapter plate P		-	38	4	4.5	-	066808
V3760-Q	Adapter plate Q		-	32	5.5	3	-	066815
V3760-R	Adapter plate R		-	36	6	4	-	066822
V3760-S	Adapter plate S		-	38	4	3	-	066839
V3760-T	Adapter plate T		-	28	5	4	-	066952
V3760-V	Adapter plate V		-	40	4	2.5	-	066969
V3760-X	Adapter plate X		-	-	-	-	-	066976
V3760-Z	Adapter plate Z		-	30	4	4.5	-	066983
V3760-8	Adapter plate 8		-	48	5.5	3	-	066990
V3760-9	Adapter plate 9		-	54	5.5	3	-	067003
V3760-0	Adapter plate 0		-	63.5	5.5	3	-	067010
V3760-0-DISC	Adapter plate 0-DISC		-	59	-	-	-	067027
V3760-K	Adapter plate K		-	54	8	4	-	067034
V3760-N	Adapter plate N		-	32	12	5	-	067041
V3760-IV	Adapter plate IV		-	42	6	9	-	067058
V3760-H6	Offset screwdriver H6		-	-	-	-	-	067065
V3760-H7	Offset screwdriver H7		-	-	-	-	-	067072
V3760-A1	Adapter plate A1		-	40	5.5	4	-	067089
V3760-B1	Adapter plate B1		-	45	6	5	-	067096
V3760-F1	Adapter plate F1		-	44	4	3.5	-	067102
V3760-P1	Adapter plate P1		-	37	6	3.5	-	067119
V3760-G1	Pressure plate G1		-	42	5	5	-	067133
V6632	Socket			10	3/8	-	9 mm	066327
V6633	Socket			12	1/2	-	22 mm	066334
V6634	Socket			12	1/2	-	20 mm	066341
V6635	Socket			12	1/2	-	11.5 mm	066358

V3760-VW, EAN 4047728**071666**
Adapter VW



V7132N, EAN 4047728076500

Brake piston readjusting tool set · hydraulic

- For multiple piston brake systems
- Uniform resetting of the brake piston, without damage to piston and sealing
- Replaceable press jaws for clamping range 30 – 70 mm
- Press jaws 360° adjustable – optimal adjustment
- Ideal for floating and fixed callipers
- Adjustable to a large range of brake calliper shapes and numbers of pistons
- Pressure plates: 2x L 90x B 2 mm · 2x L 90x B 4 mm · 2x L 150x B 4 mm
- Maximum power transmission: 2 t



Brake disc tools



V7158, EAN 4047728071581

Brake calliper screw connection set

- Brake calliper screw connection on e.g. VW · AUDI · PORSCHE · MERCEDES-BENZ · BMW · FORD · MAZDA · Volvo
- Including all common profile sizes for removal / installation of the brake calliper
- Special profiles for loosening the screw connections of separated brake callipers
- Ideal for floating and fixed brake callipers



VIGOR No.	Designation	Design	■		Size	L mm	EAN 4047728+
V6633	Socket			-	22 mm	48	066334
V6634	Socket			-	20 mm	38	066341
V6635	Socket			-	11.5 mm	50	066358
V6636	Socket			-	14 mm	50	071406
V7158-1	Socket				7 mm	24	071598
V7158-2	Socket				8 mm	24	071604
V7158-3	Socket				9 mm	20	071611
V7158-4	Socket				9 mm	50	071628
V7158-5	Socket				7 mm	65	071635
V7158-6	Socket				7 mm	92	071642
V7158-7	Socket				11 mm	100	071659
V7158-8	Socket				8 mm	30	071888

V6632, EAN 4047728066327

Socket

- Brake calliper screw connection on e.g. VW · AUDI · PORSCHE · MERCEDES-BENZ · BMW · FORD · MAZDA · Volvo

Size 9 mm



10 3/8"



V4930, EAN 4047728049306

Calliper gauge for brake discs

- Fast, effective determination of the brake disc diameter without removing the wheel first
- Time saving through clear identification of the installed brake system (advantage: fewer incorrect orders)
- Universal clamping range: 200–400 mm

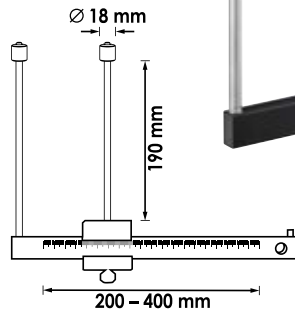

Performing the measurement without wheel removal



V4399, EAN 4047728043991

Brake disc thickness gauge

- Fast, efficient test for determining the current brake disc thickness
- Note: see the manual of the vehicle manufacturer for the minimum wear limits of the brake discs

Display range 0 – 45 mm

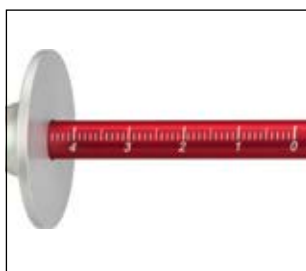

Performing the measurement without wheel removal



V7401, EAN 4047728074018

Brake disc thickness gauge · digital

- Measuring minimum thickness of brake discs
- Performing the measurement without wheel removal
- Digital LCD display
- Stainless steel design
- Note: note the minimum wear limits of the brake discs from the vehicle manufacturer manual
- Including 3 volt battery CR2032
- Measuring range of 0 – 80 mm



Tube flaring tools



V4416, EAN 4047728044165

Tube flaring tool for Ø 4.75 mm

- Exclusively for DIN flaring
- Lightweight and easy to handle
- Exact positioning of the brake line in the device using a spacing adapter
- Application on brake and hydraulic lines directly on the vehicle
- For thin-walled pipes made of steel, aluminium and copper (metric / inch)
- No damage to coated lines
- For DIN "F" flares 180°



For DIN "F" flares



Particularly suited for direct use on the vehicle

VIGOR No.	Designation	Design	EAN 4047728+
V4416-1	DIN flaring screw 4.75 mm		049313
V4416-2	Screw sleeve		049337
V4416-3	Spacing screw		049344
V4416-4	Bolt		049351
V4416-5	Handle		049375

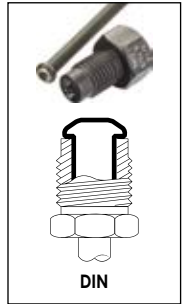

V4697, EAN 4047728046978

Tube flaring tool for Ø 4.75 mm

- Flared tube ends of Ø 4.75 mm lines according to DIN and SAE standards
- Extremely small construction ensures that it is possible to work in confined spaces
- No damage to coated lines
- Distance adapter prevents incorrect positioning of the brake line
- For steel, aluminium and copper lines
- For 180° DIN "F" flares, as well as SAE "F" double flares
- Contents:
 - 1 basic unit
 - 1 DIN flare adapter
 - 1 SAE flare adapter
 - 1 distance adapter
 - 1 special grease



For DIN · SAE and F flares



Particularly suited for direct application on the vehicle due to easy handling

VIGOR No.	Designation	Design	EAN 4047728+
V4416-1	DIN flaring screw 4.75 mm		049313
V4416-2	Screw sleeve		049337
V4416-3	Spacing screw		049344
V4416-4	Bolt		049351
V4697-1	Flaring screw (SAE) · 4.75 mm		049320
V4697-2	Handle		049368

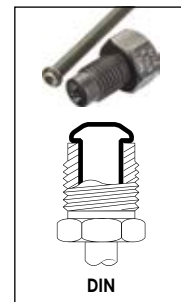

V1728, EAN 4047728017282

Tube flaring tool set

- Direct application on brake and hydraulic lines on vehicles
- For thin-walled pipes made of steel, aluminium and copper (metric / inch)
- Producing convex and double flares (DIN/SAE standards)
- No damage to coated lines
- For 180° DIN "F" flares and SAE "F" double flares, as well as simple "D" flares



For DIN · SAE flares



VIGOR No.	Designation	Design	EAN 4047728+
V2466	Quick-change holder		024662
V2559	Basic unit		025591
V2467	Hydraulic spindle		024679
V2558	Thrust block 90° DIN / SAE		025584
V2553	Thrust block DIN/SAE		025539
V2554	Thrust block DIN/SAE		025546
V2556	Thrust block DIN/SAE		025560
V2555	Thrust block DIN/SAE		025553
V2626	Tube cutter		026260
V2551	Set of gripping jaws 5 mm		025515
V2552	Set of gripping jaws 6 mm		025522
V2540	Set of gripping jaws 4.75 mm		025409
V1782	Tube bending tool		017824



Tube flaring tools



V5513, EAN 4047728055130

Tube flaring tool set

- Flaring steel, aluminium or copper brake lines with \varnothing 4.75 · 5 · 5.15 · 5.25 · 6 mm
- Modern BMW and VAG brake lines are covered with an additional plastic layer (\varnothing 5.15 / 5.25 mm)
- Flaring is not possible with standard tube flaring tools
- Exclusively for DIN flaring
- Direct application on brake and hydraulic lines on vehicles

For new VAG and BMW brake lines with additional covering

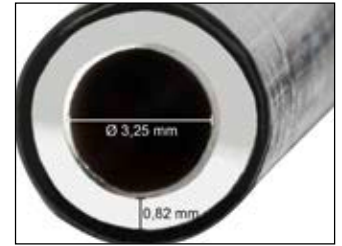

New brake line



Positioning of line to scrape the covering



Mounting the union nut



Positioning the line



DIN flaring process



VIGOR No.	Designation	Design	EAN 4047728+
V5513-1	DIN flaring screw 6 mm		055147
V5513-2	Line cutter 3 - 16 mm		055154
V5513-3	Line scraper 3 - 16 mm		055161
V4416-1	DIN flaring screw 4.75 mm		049313
V4416-2	Screw sleeve		049337
V4416-3	Spacing screw		049344
V4416-4	Bolt		049351
V4697-2	Handle		049368
V1782	Tube bending tool		017824



V5649, EAN 4047728056496

Deburrer for brake lines · inside / outside

- For deburring of brake lines
- For pipe inside \varnothing 3 – 12 mm
- For pipe outside \varnothing 4 – 14 mm
- For deburring of brake lines
- For steel, copper, stainless steel, aluminium lines

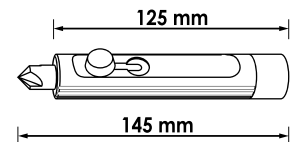

V2789N, EAN 4047728062824

Brake and fuel line inspection tool

- Detection of hidden corrosion during general inspection
- 12 cleaning edges for removal of dirt and rust from various lines
- \varnothing 3.5 mm · 4.0 mm · 4.75 mm

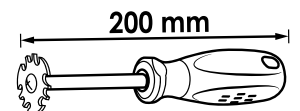

V5691, EAN 4047728056915

Brake calliper file

- For removing brake dust, rust and dirt from the brake calliper without damaging the brake sleeves
- Extremely narrow design allows high flexibility
- All four sides of the square are toothed with 2 different thicknesses (cut)
- Width square: 9 mm

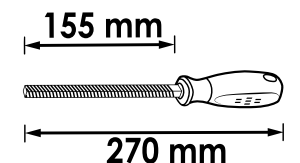
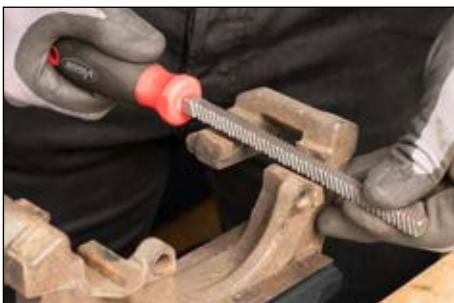

V5909, EAN 4047728059091

Brake hook

- For hanging up the brake calliper during work on brakes (prevents damage to the brake hose)
- Also suitable for hanging up hoses or cables
- Surface: dip-insulated



V2250, EAN 4047728022507

Brake calliper brush · steel

- Removal of stubborn brake dust
- Very slim design



With hanging hole

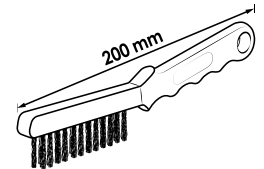

V2249, EAN 4047728022491

Brake calliper brush · brass

- Cleaning aluminium brake callipers
- Removal of stubborn brake dust
- Allows access into small brake callipers



With hanging hole

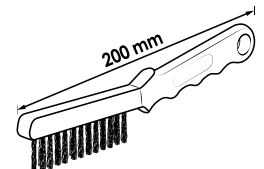

V6917, EAN 4047728069175

Brake line ratcheting tube cutter

- Space saving, with ratchet mechanism.
- For 4.75 mm brake lines
- Ratcheting mechanism in the head of the tool minimises space required – can be used directly on the vehicle
- No readjustment of the cutting wheel due to self-adjustment
- Faster cutting result than conventional line cutters
- Adjustment of the self-adjusting cutting force possible
- Spare blades V6917-REP



Self-adjusting

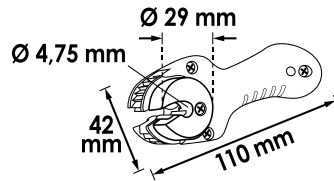

V6917-REP, EAN 4047728069199

Spare cutter wheel for brake line ratcheting tube cutter V6917



V1782, EAN 4047728017824

Tube bending tool

- For tubes made of copper, brass, aluminium and soft steel
- Can be bent up to 90°
- Bending pipes measuring 3 mm, 4.75 mm and 6 mm Ø

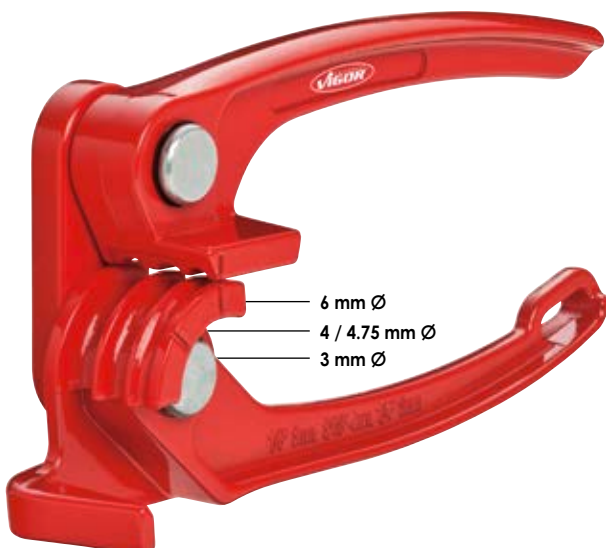

- 6 mm Ø
- 4 / 4.75 mm Ø
- 3 mm Ø



V7244, EAN 4047728072441

Brake line straightening tool \varnothing 4.75 mm

- Easy straightening of 4.75 mm lines
- Especially for brake lines made of steel or copper-nickel
- Effective method for straightening misshapen lines, especially for reels
- Simply sliding back and forth is sufficient as an application impulse
- Targeted straightening reduces the material costs
- Replaces conventional, imprecise shaping of wires



V7259, EAN 4047728072595

Brake line bending tool \varnothing 4.75 mm

- Bending device for easy duplication of brake pipes that keep their shape



V7120, EAN 4047728077200

Brake line holding tool

- Non-damaging grip on \varnothing 4.75 mm brake lines thanks to optimised clamping
- The brake line can be re-bent in the installed state to replicate the exact shape of the original
- For steel, copper-nickel and plastic-coated brake lines

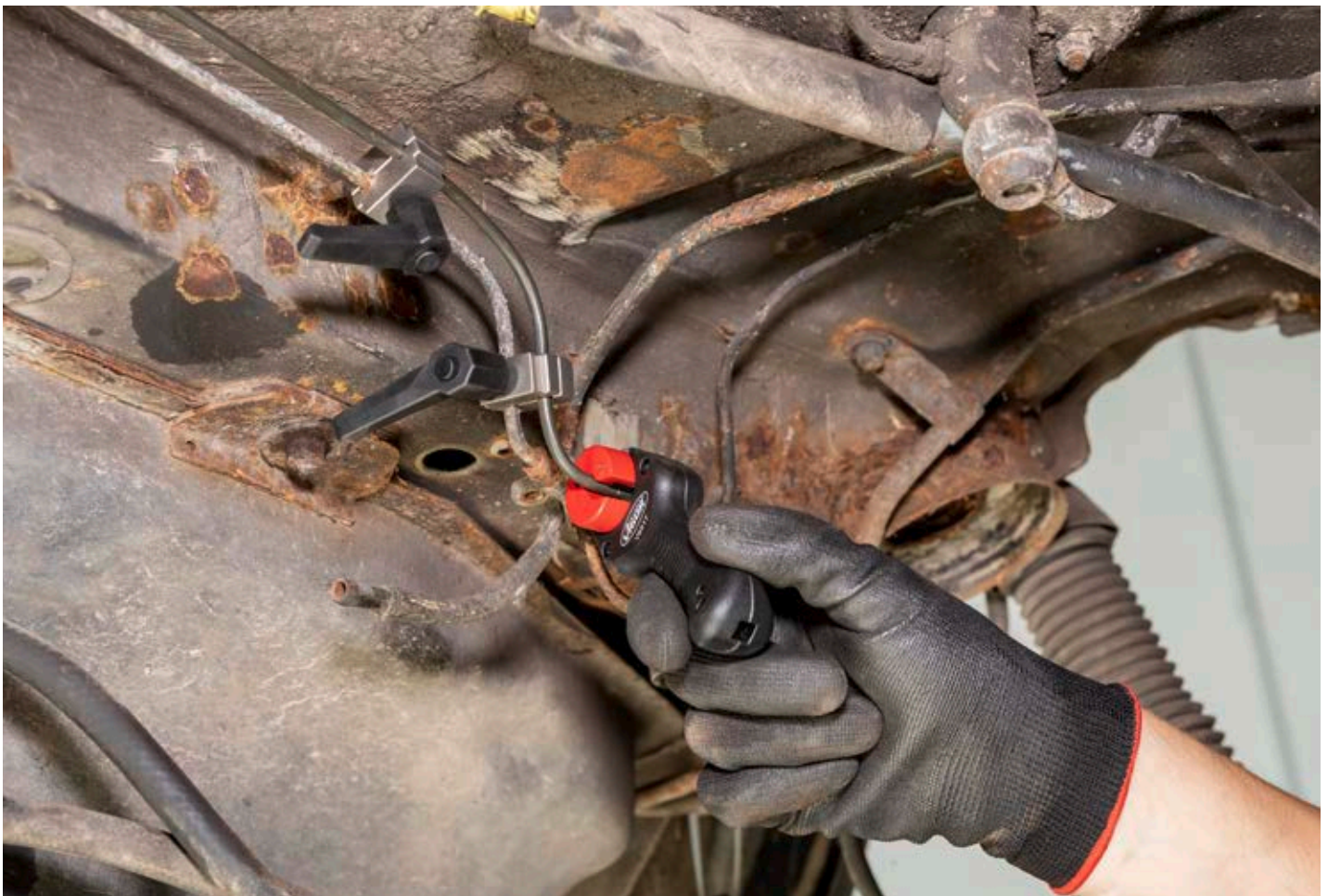
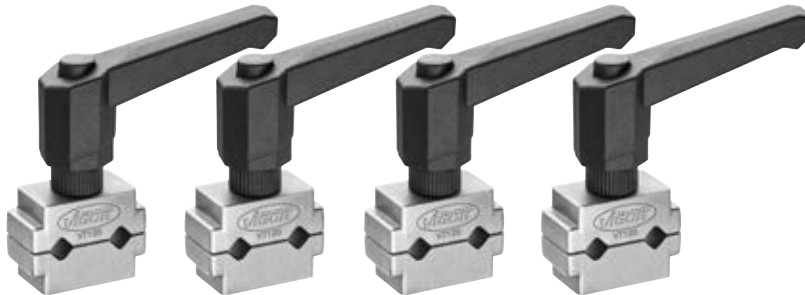



Wheels / tyres

Impact sockets

296–298

Service jacks and jack stands

299–302

Wheel / tyre tools

303–306



V6311, EAN 4047728077798

Impact socket · TESLA

- 22.2 mm hexagon or 7/8"
- 21 mm wheel nuts can deform and expand plastically due to weather conditions

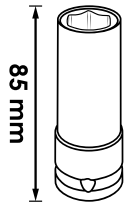

V4309, EAN 4047728043090

Impact socket · MERCEDES BENZ

- Operating wheel bolts with a MERCEDES-BENZ special profile
- For the following models:
 - C-Class · GLK (W204)
 - E-Class (W211 · W212 · W207)
 - SLK (W172)
 - M-Class (W164 · W166)
 - CL-Class (W216)
 - S-Class (W221, W222)
 - MAYBACH
- For impact operation

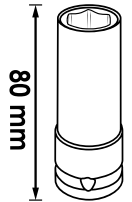

V6309, EAN 4047728075534

Impact socket set

- Operation of damaged 19 mm FORD wheel nuts
- For e.g.: FORD B-Max · C-Max · Fiesta · Focus · Mondeo · Transit
- Contents:
 - 18.5 mm impact socket for wheel nuts with missing chrome cap
 - 19.5 mm impact socket for wheel nuts with deformed chrome cap

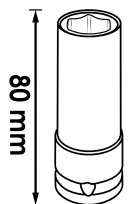
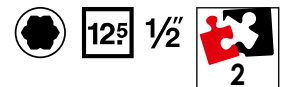

V5930, EAN 4047728059305

Impact socket · long

- Damage-free operation of wheel bolts by rotating plastic sleeve
- For impact operation



Comparison of standard socket to extra long socket



Size 17 mm

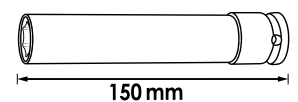

Impact sockets



V5931, EAN 4047728060318

Impact socket · long

- Damage-free operation of wheel bolts by rotating plastic sleeve
- For impact operation



Size 19 mm

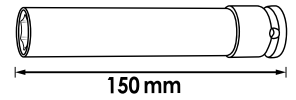

Comparison of standard socket to extra long socket



V5932, EAN 4047728079617

Impact socket · long

- Damage-free operation of wheel bolts by rotating plastic sleeve
- For impact operation



Size 21 mm

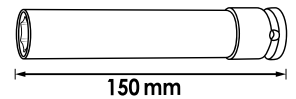

NEW



V6312/10, EAN 4047728077804

Impact socket set

- Damage-free operation of wheel bolts by rotating plastic sleeve
- Set with all required sockets
- For impact operation

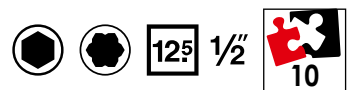

V5933/3, EAN 4047728079624

Impact socket set · extra long

- Damage-free operation of wheel bolts by rotating plastic sleeve
- Extra long design
- Sizes 17 · 19 · 21 mm
- For impact operation

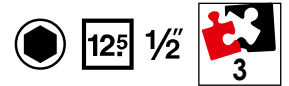

NEW

VIGOR No.	■	Ø	Size	← L → mm	EAN 4047728+
V5930		26	17 mm	150	059305
V5931		28	19 mm	150	060318
V5932		30	21 mm	150	079617



V2522, EAN 4047728025225

Impact socket set

- For impact operation

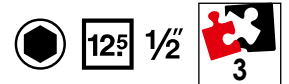

VIGOR No.	Size	← L → mm	EAN 4047728+
V2472	17 mm	85	024723
V2473	19 mm	85	024730
V2474	21 mm	85	024747

V2257, EAN 4047728022576

Impact socket set

- For impact operation

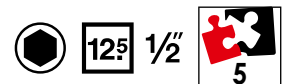

VIGOR No.	Size	← L → mm	EAN 4047728+
V2471	15 mm	85	024716
V2472	17 mm	85	024723
V2473	19 mm	85	024730
V2474	21 mm	85	024747
V2475	22 mm	85	024754

Service jacks and jack stands



V2481, EAN 4047728024815

Hydraulic aluminium service jack 1.35 tonnes

- Wheel change on the vehicle or repairs under the vehicle, for which a lifting platform is not necessary
- \approx 10 kg

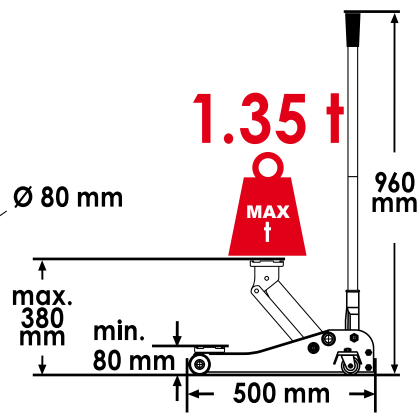
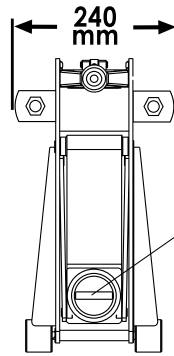

Aluminium – only 10 kg

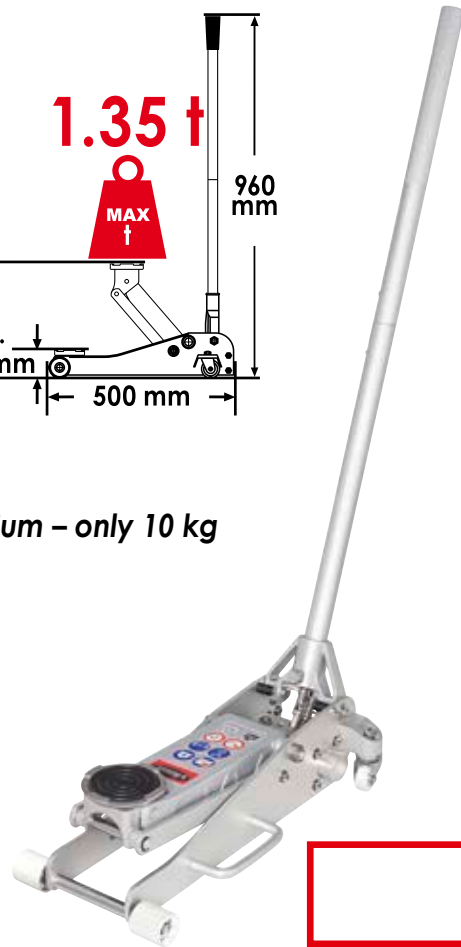

VIGOR No.	Designation	EAN 4047728+
V2631	Fixed castor (pair)	026314
V2632	Swivel castor (pair)	026321
V2639	Hydraulic unit	026390
V2640	Rubber pad	026406

V6028, EAN 4047728060288

Hydraulic service jack 2 tonnes · ultra-flat

- Wheel change on the vehicle or repairs under the vehicle, for which a lifting platform is not necessary
- Solid rubber pad for firm hold
- Fast lift thanks to turbo-lift function
- Robust steel body - guarantees high quality
- Quiet castors made from Polyurethane
- \approx 32 kg

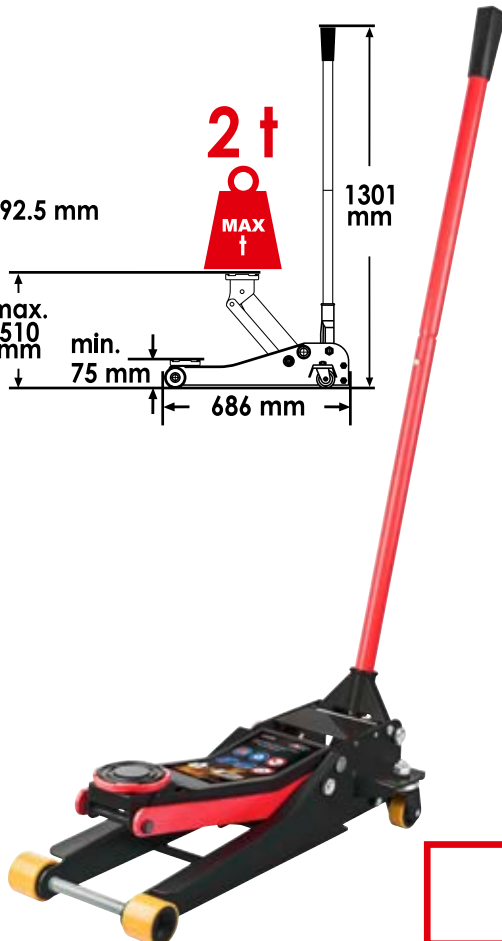
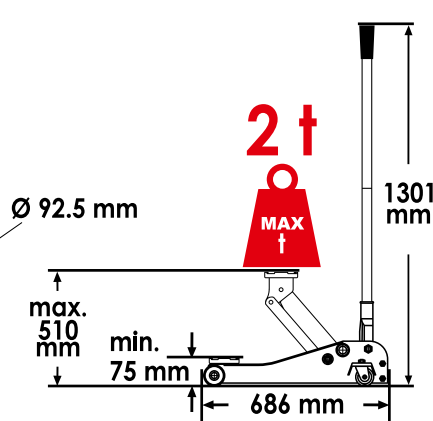
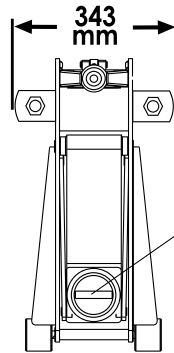

VIGOR No.	Designation	EAN 4047728+
V6028-1	Fixed castor (pair)	062503
V6028-2	Swivel castor (pair)	062497
V6028-3	Rubber pad	062480
V6028-4	Hydraulic unit for V6028	062473



V6031, EAN 4047728071109

Hydraulic service jack 2 tonnes · extra long

- Wheel change on the vehicle or repairs under the vehicle, for which a lifting platform is not necessary
- \approx 42 kg

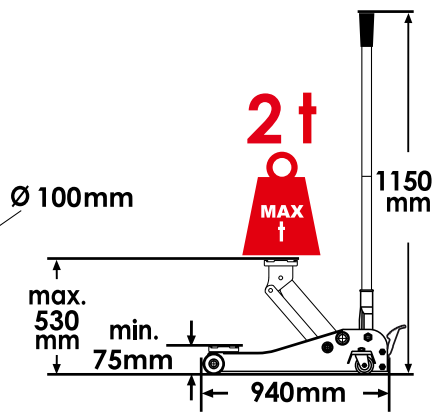
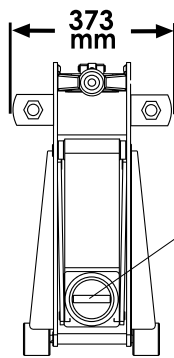

VIGOR No.	Designation	EAN 4047728+
V6031-1	Fixed castor (pair)	075879
V6031-2	Swivel castor (pair)	075886
V6031-3	Rubber pad	075893

V6029, EAN 4047728069786

Hydraulic service jack 3 tonnes

- Wheel change on the vehicle or repairs under the vehicle, for which a lifting platform is not necessary
- \approx 31 kg
- Compact design
- Quiet castors made from Polyurethane

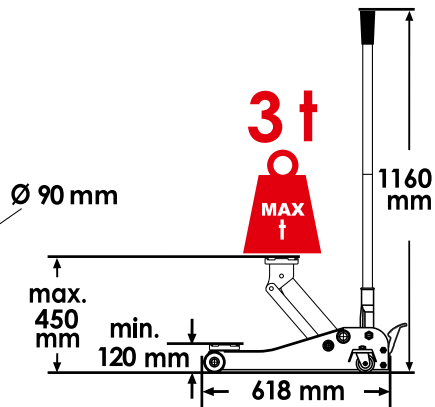
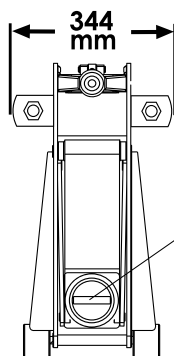

Foot pedal enables quick attachment to the service jack point

VIGOR No.	Designation	EAN 4047728+
V6029-1	Fixed castor (pair)	075855
V6029-2	Swivel castor (pair)	075848
V6029-3	Rubber pad	075862

Service jacks and jack stands



V2478, EAN 4047728024785

Hydraulic bottle jack 6 tonnes

- Vertical and horizontal applications
- ⚖️ 4.4 kg

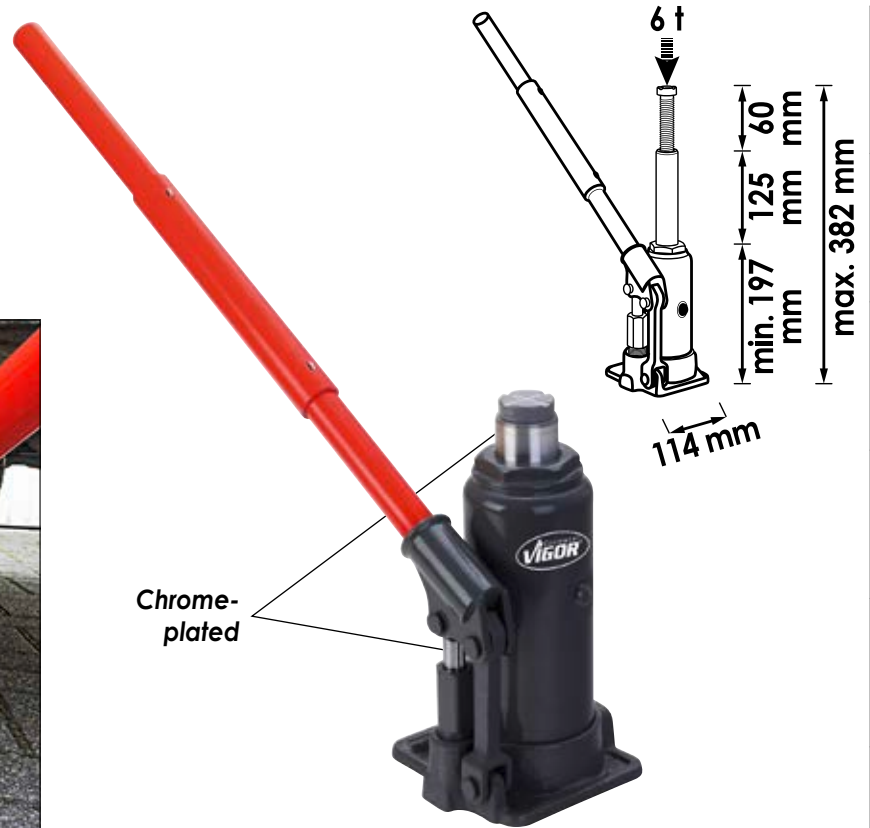

V2477, EAN 4047728024778

Jack stand set 3 tonnes

- ⚖️ 5.2 kg per pair
- Loading capacity: 3 tonnes
- Height 315 – 460 mm
- Depth: 230 mm



VIGOR No.	Designation	EAN 4047728+
V2762	Rubber pad	027625



V2648, EAN 4047728**026482**

Jack stand set 6 tonnes

- 11 kg per pair
- Loading capacity: 6 tonnes
- Height 370 – 575 mm
- Depth: 300 mm

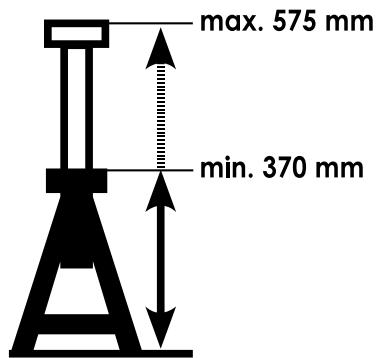

VIGOR No.	Designation	EAN
V2762	Rubber pad	4047728+ 027625



V3563, EAN 4047728035637

Tyre lever with plastic coating

- Installing and removing tyres on steel and especially on aluminium rims
- Length: 500 mm



Chrome-plated

With replaceable plastic coating fixed with screws, including screws



VIGOR No.	Designation	EAN 4047728+
V3615	Plastic coating with screws	036153

V2512, EAN 4047728025126

Balance weight remover set

- Removing balance weights from light-alloy rims on motorcycles and passenger cars
- Solvent resistant
- Blunt edges may be sharpened with a file
- Also suitable for removing labels and stickers
- No damage to surfaces



VIGOR No.	mm	mm	EAN 4047728+
V2513	19	500	025133
V2514	22	500	025140
V2515	25	500	025157
V2516	38	500	025164



V1657, EAN 4047728016575

Balance weight pliers

- Fastening, loosening and cutting balance weights

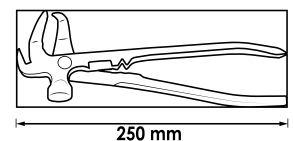

V1584, EAN 4047728015844

Tyre tread depth gauge

- Detecting wear patterns on tyres, brake blocks and brake pads
- Zero-setting in any position
- 3 V (CR 2032)–240 mAh

Maximum 27 mm



Large LCD display

Can be switched between mm/inches



V1423, EAN 4047728014236

Tyre pressure gauge

- Quick tyre pressure check
- Small and handy
- Digital display
- Measuring ranges:
 - 0.15 - 7 bar
 - 2 - 99.5 PSI
 - 15 - 70 KPA
- 3 V (CR 2032) - 240 mAh



Automatic shut-off after 90 sec.

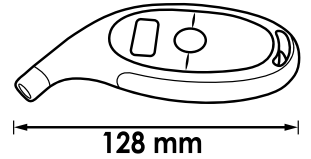

128 mm



Rubber hammer

- Loosening rusted rims during a wheel change



Plastic handle

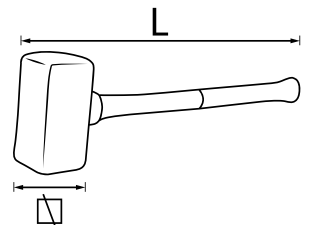

Non-rebound due to steel-ball filling



VIGOR No.	mm	kg	EAN 4047728+
V2235	50	2.5	022354
V2234	74	5	022347

V1571, EAN 4047728015714

Steering wheel level

- Alignment of the steering wheel during axle alignments and work around the steering column
- Quick installation
- Simple adjustment to the steering wheel
- Easy to read
- Universal use for passenger cars, vans and trucks
- Use of the steering wheel level prevents incorrect steering wheel positions
- An exact axle alignment should always be carried out using a calibrated alignment device

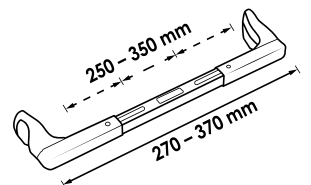
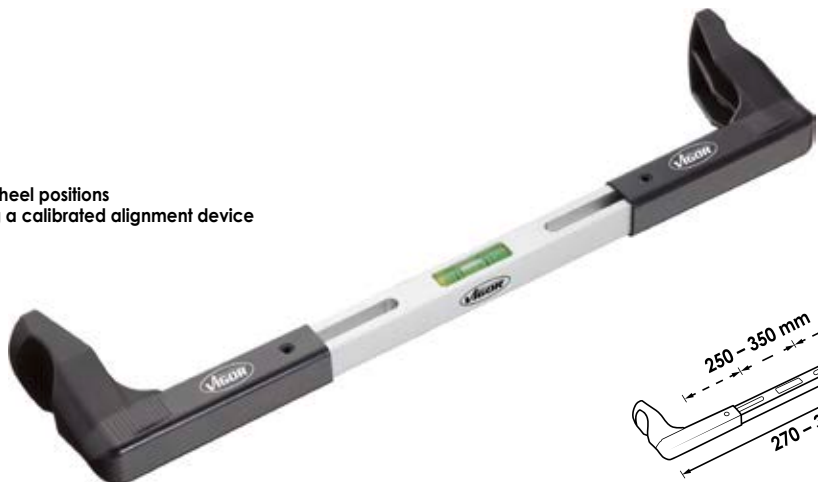

V7181, EAN 4047728071819

Tap and die set for wheel bolts and wheel nuts

- Damaged or rusty threads can result in incorrect torque values
- Repairing and cleaning of wheel bolts and wheel nuts with inside and outside thread
- Can be used directly on the vehicle
- TIN-HSS coated surface
- In plastic case
- Suitable for the thread sizes:
 - M 12x1.25 mm
 - M 12x1.5 mm
 - M 14x1.5 mm



Damaged or rusty threads can result in incorrect torque values

Inside thread



Outside thread



VIGOR No.	Designation	Design	EAN 4047728+
V7181-1	Die · M 12x1.25 TIN		071840
V7181-2	Die · M 12x1.5 TIN		071833
V7181-3	Die · M 14x1.5 mm TIN		071826
V7181-4	Hand tap · M 12x1.25 TIN		071864
V7181-5	Hand tap · M 12x1.5 TIN		071857
V7181-6	Hand tap · M 14x1.5 TIN		071871



V7001, EAN 4047728075060

Universal rim lock removal set

- Malleable rim keys for loosening almost all rim locks
Also for rim locks with clover leaf profile, among others
- Malleable rim keys adapt to the profile by hammer strike
- Can be used on both sides
- Multiple deformation of a key side not possible
- Contents:
 - 8 rim keys
 - 2 adapters
 - Socket □ 12.5 mm (1/2") - size 24 mm
 - Impact body
 - Centring pin
 - Hand guard trim



V7001/4, EAN 4047728075336

Rim key set

- Key set with Ø 13 mm and 15 mm can be used on both sides
- For universal rim lock removal set V7001
- Material: AHSS (carbon steel)

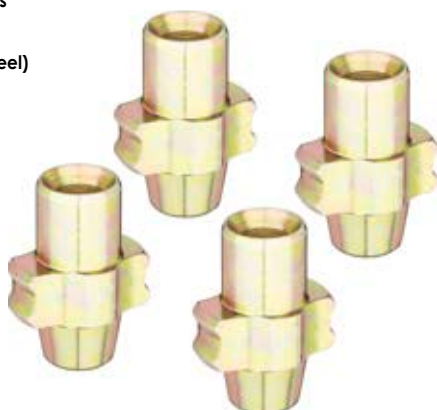



Body

Wiper arm puller set

308

Repair and installation sets

309

Induction heater and accessories

310-314



V2523, EAN 4047728**025232**

Wiper arm puller set

- Universally usable
- For easy removal of all common wiper arms
- Optimum usability options with rusted and stuck wiper arms
- Best possible protection for integrated wiper nozzles when used with a sliding hammer



VIGOR No.	Designation	Design	EAN 4047728+
V4153	Puller · universal		041539
V4154	Sliding hammer		041546
V4155	Pressure spindle		041553
V4156	Spindle extension		041560
V4157	Spindle attachment		041577
V4159	Gripper no. 1		041591
V4160	Gripper no. 2		041607
V4161	Gripper no. 3		041614
V4163	Gripper no. 5		041638
V4164	Gripper no. 6		041645
V4165	Gripper no. 7		041652
V4158	Gripper no. 8		041584



V3551N, EAN 4047728075084

Repair set for plastic parts

- Repair and reinforcement of plastic parts, such as cracked light bars and housing parts
- Extensive and practical for household, workshop or handicrafts
- 3-in-1 function with replaceable fixtures
- Stainless steel staples
- Included in delivery:
 - 50 type W repair staples / Ø 0.6 mm
 - 50 type W repair staples / Ø 0.8 mm
 - 5 welding rods each, material PE, PS, ABS
 - 10 welding rods, material PP
 - 2 reinforced grids
- Power: 50 watts
- Maximum useful life: 35 min
- Charging time: 3.5 hours

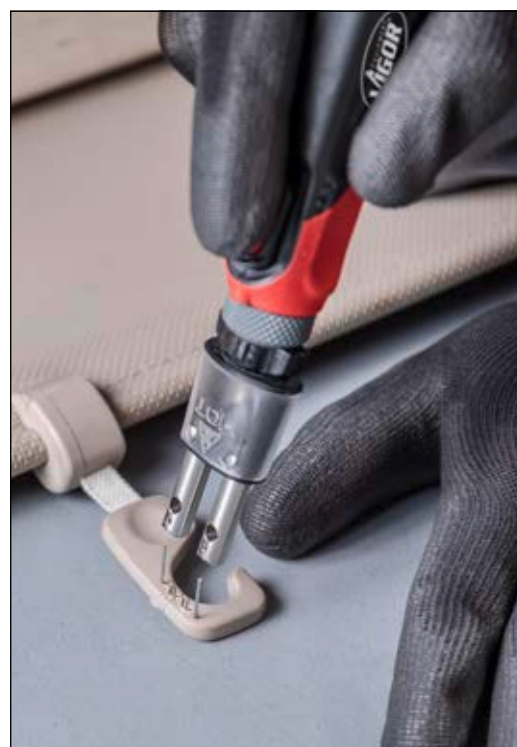

VIGOR No.	Designation	Design		EAN 4047728+
V3670N	Replacement staples · 0.8 mm · V-formed		100	075671
V3671N	Replacement staples · 0.6 mm · V-formed		100	075688
V3672N	Replacement staples · 0.8 mm · W-formed		100	075695
V3673N	Replacement staples · 0.6 mm · W-formed		100	075701
V3676N	Replacement staples · 0.6 mm · U-formed		100	075718
V3677N	Replacement staples · 0.8 mm · U-formed		100	075725
V3551N-ABS	Plastic welding rods Abs		10	077170
V3551N-PE	Plastic welding rods Pe		10	077149
V3551N-PP	Plastic welding rods Pp		10	077156
V3551N-PS	Plastic welding rods Ps		10	077163
V3551N-W	Reinforced grids		5	077132



V4891-1.0, EAN 4047728080217

Induction heater

- Compact induction heater for flameless heating of components and workpieces
- Risk minimisation compared to oxy-acetylene burners
- LED on the coil head indicates operation
- Compact unit in relation to the output power of 1 kW
- Precise heating in just a few seconds with cutting-edge microprocessor technology
- Power supply: 230 V
- Set consisting of:
 - V4891-1 (Tube coil)
 - V4891-2 (Flexible coil)
 - V4891-3 (Tube coil)
 - V4891-4 (Flat coil)

NEW



V4891, EAN 4047728**048910**

Induction heater

- Quick, simple removal of parts on vehicles by heating
- Extremely versatile in the car body and commercial vehicle sector due to extensive standard accessories
- Precise heating in just a few seconds with cutting-edge microprocessor technology
- Easy to transport thanks to plastic case
- Prevention of overheating with a simultaneously high degree of efficiency due to two fans
- Connecting cable: 3 m
- Reel hose length: 700 mm
- Controlled fan cooling
- Tube coils: heating pipes, bolts, profiles of various diameters
- Flexible coil: for loosening parts that are difficult to access due to the use of a special winding wire
- Flat coil for heating the car body and sheet metal, makes it easier to remove stickers, sealants etc.
- Robust IGBT transistor technology
- Short circuit and idling test
- Automatic adaptation to resonance frequency
- Frequency: 25 kHz – 60 kHz
- 1.5 kW output

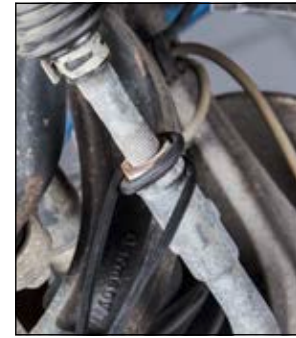

Accurately positioned heating within a few seconds due to cutting-edge microprocessor technology

Including 4 coils



V4891-1, EAN 4047728**049573**

Tube coil

- Total length: 222 mm
- Vertical alignment
- Inside diameter 19 mm, up to maximum M 8

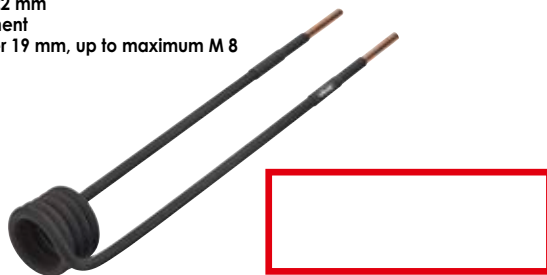

V4891-2, EAN 4047728**049580**

Flexible coil

- Total length: 750 mm
- Flexible use on individual motor vehicle components
- For hard-to-reach places

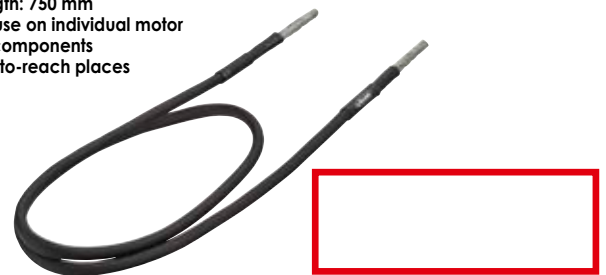

V4891-3, EAN 4047728**049597**

Tube coil

- Total length: 225 mm
- Vertical alignment
- Inside diameter 26 mm, up to maximum M 12



V4891-4, EAN 4047728**049603**

Flat coil

- Optimal for heating surfaces
- Heating of flat screws
- Total length: 227 mm
- Inside diameter: 24 mm
- Outer diameter 45 mm

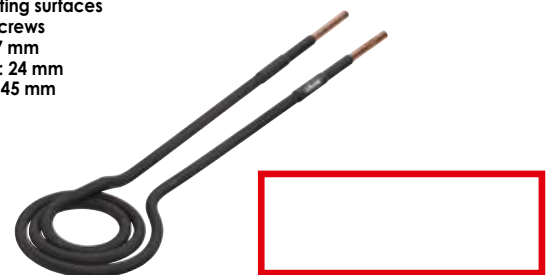



V4891/6, EAN 4047728062206

Induction coil expansion set

- Set consisting of:
 - V4891-5 (Focus coil for punctual heating)
 - V4891-6 (Tube coil)
 - V4891-7 (Tube coil)
 - V4891-8 (Flexible coil, ceramic protection)
 - V4891-9 (Tube coil)
 - V4891-10 (tube coil, lateral)
- Compatible with induction heater V4891 and V4891-1.0



V4891-5, EAN 4047728062152

Focus coil · for punctual heating

- For heating components which can not be reached with standard coils
- Coil for heating with pinpoint accuracy, to concentrate the energy
- During heating, a distance of approx. 2 – 4 mm from the workpiece must be maintained to prevent damage to the coil
- Total length: 210 mm



V4891-6, EAN 4047728062169

Tube coil

- Total length: 220 mm
- Vertical alignment
- Inside diameter 15 mm, up to maximum M 6



V4891-7, EAN 4047728062176

Tube coil

- Total length: 240 mm
- Horizontal alignment
- Inside diameter 45 mm, up to maximum M 22

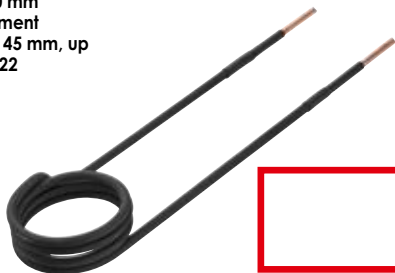

V4891-8, EAN 4047728062183

Flexible coil · ceramic protection

- Total length: 800 mm
- Higher temperature resistance
- The ceramic coating extends the service life
- Self-adjusting distance for smaller components



V4891-9, EAN 4047728062190

Tube coil

- Total length: 220 mm
- Vertical alignment
- Inside diameter 45 mm, up to maximum M 22



V4891-10, EAN 4047728062343

Tube coil · lateral

- Total length: 230 mm
- Horizontal alignment
- Inside diameter 23 mm, up to maximum M 10



V4891-3.5, EAN 4047728072779

Induction heater · truck 3.5 KW

- Powerful 3.5 KW variant for motor vehicles and commercial vehicle applications
- Efficient method of heating, without damaging surrounding components
- Water-cooled
- Portable, despite high performance
- Output power can be precisely adjusted for the application field
- Force can be output in increments between 10-100%
- As-delivered condition including coolant
- Precise heating of components and elements
- Operating information via LED on the coil head
- Additional fan in the housing provides overheating protection for the hardware components
- Precise heating in just a few seconds with cutting-edge microprocessor technology



V4891-3.5-1, EAN 4047728072786

Expansion coil · Wheel bolt

- Extra slim design allows for precise heating of wheel bolts



V4891-3.5-2, EAN 4047728072793

Standard coil · lateral



V4891-3.5-3, EAN 4047728072809

Reducer

- Reducer for adapting plug-in coil V4891-3.5-4



V4891-3.5-4, EAN 4047728072816

Plug-in coil · 26 mm

- Plug-in coil · 26 mm
- Only together with V4891-3.5-3



V4891-3.5-6, EAN 4047728072892

Round coil · 32 mm



V4891-3.5-5, EAN 4047728072823

Coolant · 3 l



V4891-10.0, EAN 4047728077958

Induction heater

- Ultra-strong 10 kW variant for heating solid components
- Mobile unit with chassis and integrated water cooling system
- Quiet operation
- Efficient method of heating, without damaging surrounding components
- Risk minimisation compared to oxy-acetylene burners
- 10 litre, water cooled
- Compact unit in relation to the output power of 10 kW
- Output power can be precisely adjusted for the application field
- Stepless power control from 10 to 100 percent
- As-delivered condition including coolant
- LED on the coil head indicates operation
- Precise heating in just a few seconds with cutting-edge microprocessor technology
- Power supply 400 V · 32A



V3863, EAN 4047728**038638**

Shock absorber assembly tool set

- Installation / removal on shock absorbers with rebound spring
- Clamping pieces with V-formed plastic inserts enable fixation in final stop position without causing any damage
- For: BMW · FIAT · FORD · MERCEDES-BENZ · NISSAN · PEUGEOT · TOYOTA
- Contents:
 - Special base component
 - Sturdy threaded spindle M 12 with special receptacle
 - Universal clamping piece with V-formed plastic inserts

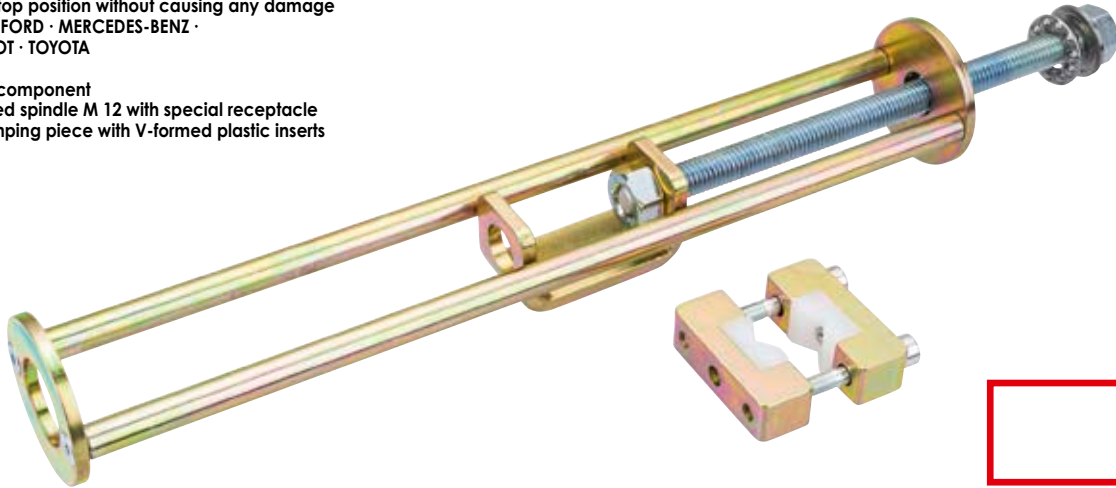

V3661, EAN 4047728**036610**
Clamping piece with plastic protective jaws (universal)



V4126N, EAN 4047728**078566**

Clamping screw removal tool set

- To actuate the clamping screw on the VAG multi-link axle in the installed state
- No pressing or pulling on the aluminium steering knuckle
- Drilling guides guarantee exact drilling of the steel screw
- Contents:
 - 3 high-performance drills (HSS cobalt) size: 6 · 8.5 · 10 mm
 - 1 pressure clamp
 - 1 drift punch
- For example:
 - AUDI A4 model year 2015→ · A5 model year 2016→ · A6 model year 2018→ · A7 model year 2017→ · Q5 model year 2016→ · Q7 model year 2015→ · Q8 model year 2018→ · E-Tron model year 2018→
 - VW Touareg model year 2017→



VIGOR No.	Ø	EAN 4047728+
V4248	6	042482
V4249	8.5	042499
V4250	10	042505



V6452, EAN 4047728**064521**

Shock absorber tool set

- Professional repair work on spring struts (counterholding the piston rod when removing and installing)
- Operation of shock absorbing nuts on strut bearings
- For the most common vehicle types
- Contents:
 - Open reversible ratchet, size 21 mm, 12-point
 - Open 6-point sockets:
 - 12.5 mm (1/2"), size 16 · 17 · 18 · 19 · 21 · 22 · 24 mm
 - 12.5 mm (1/2") screwdriver socket, size 6 · 7 · 8 mm
 - 12.5 mm (1/2") extension: 250 mm
 - 12.5 mm (1/2") sockets, oval 5x8 mm, 6x8 mm



VIGOR No.	Designation	Design	EAN 4047728+
V6452-1	Reversible ratchet · open		075220
V6452-5	Socket special profile · MERCEDES-BENZ · 5 mm		075206
V6452-6	Socket special profile · MERCEDES-BENZ · 6 mm		075213
V6452-16	Socket · 16 mm		075091
V6452-17	Socket · 17 mm		075107
V6452-18	Socket · 18 mm		075114
V6452-19	Socket · 19 mm		075121
V6452-21	Socket · 21 mm		075138
V6452-22	Socket · 22 mm		075145
V6452-24	Socket · 24 mm		075152
V6452-250	Sliding T-handle · 250 mm		075169
V6452-H6	6-point socket · 6 mm		075176
V6452-H7	6-point socket · 7 mm		075183
V6452-H8	6-point socket · 8 mm		075190



V6956, EAN 4047728069564

Universal axle lever

- Proper, careful installation and removal of axle components such as ball joints and wishbones for example
- Chain adjustment enables flexible use and adaptation to different dimensions and circumstances
- High quality spindle ensures easy working and a high transmission of force
- Direct use on the vehicle without requiring a second person
- Rubber-insulated supporting surface ensures secure hold on the vehicle
- For operation with reversible ratchet or air ratchet

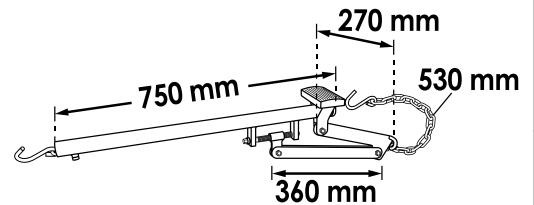

V4642, EAN 4047728046428

Cardan shaft puller · universal

- Proper disassembly of the homokinetic joint and the rubber boots of the drive shaft
- Extra-wide frame, also for large hinges

Specially shaped clamping jaws ensure a secure grip on the drive shaft

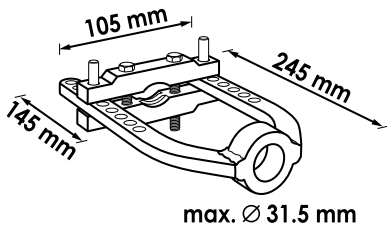

V7525, EAN 4047728075251

Universal pressing support

- Removal and installation of bearings and bushings together with workshop presses
- Optimised three-point alignment of workpieces on the workshop press
- Extensive adjustability allows almost all workpieces to be aligned parallel to the workshop press, thus increasing safety during use
- Lateral stop position for a secure hold on the workshop press
- Swivel base enables quick and easy positioning on the base
- Maximum permitted loading capacity: 20 tonnes



V4636N, EAN 4047728078719

Inner bearing extractor

- For inner bearing rings that rest against the wheel hub
- For rings in the clamping range 33 – 60 mm
- Replaceable cones with \varnothing 32 mm and \varnothing 40 mm for extensive market coverage
- Also suitable for models with ABS cage, e.g. VW Golf 4
- Fixing screw prevents the arms from slipping off
- Operation with reversible ratchet



Included in delivery

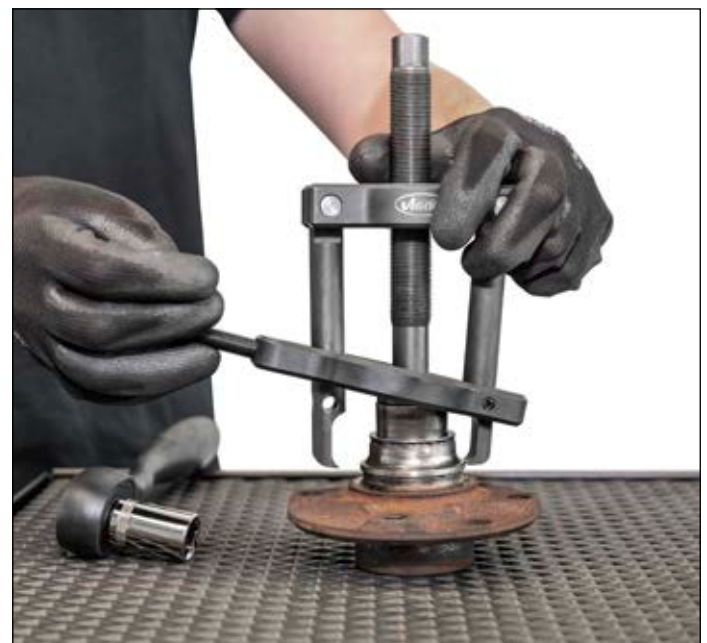
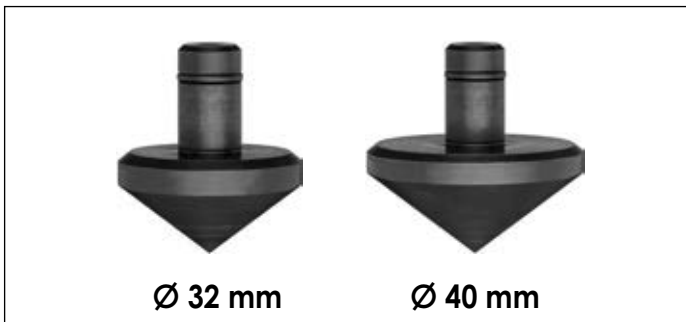

VIGOR



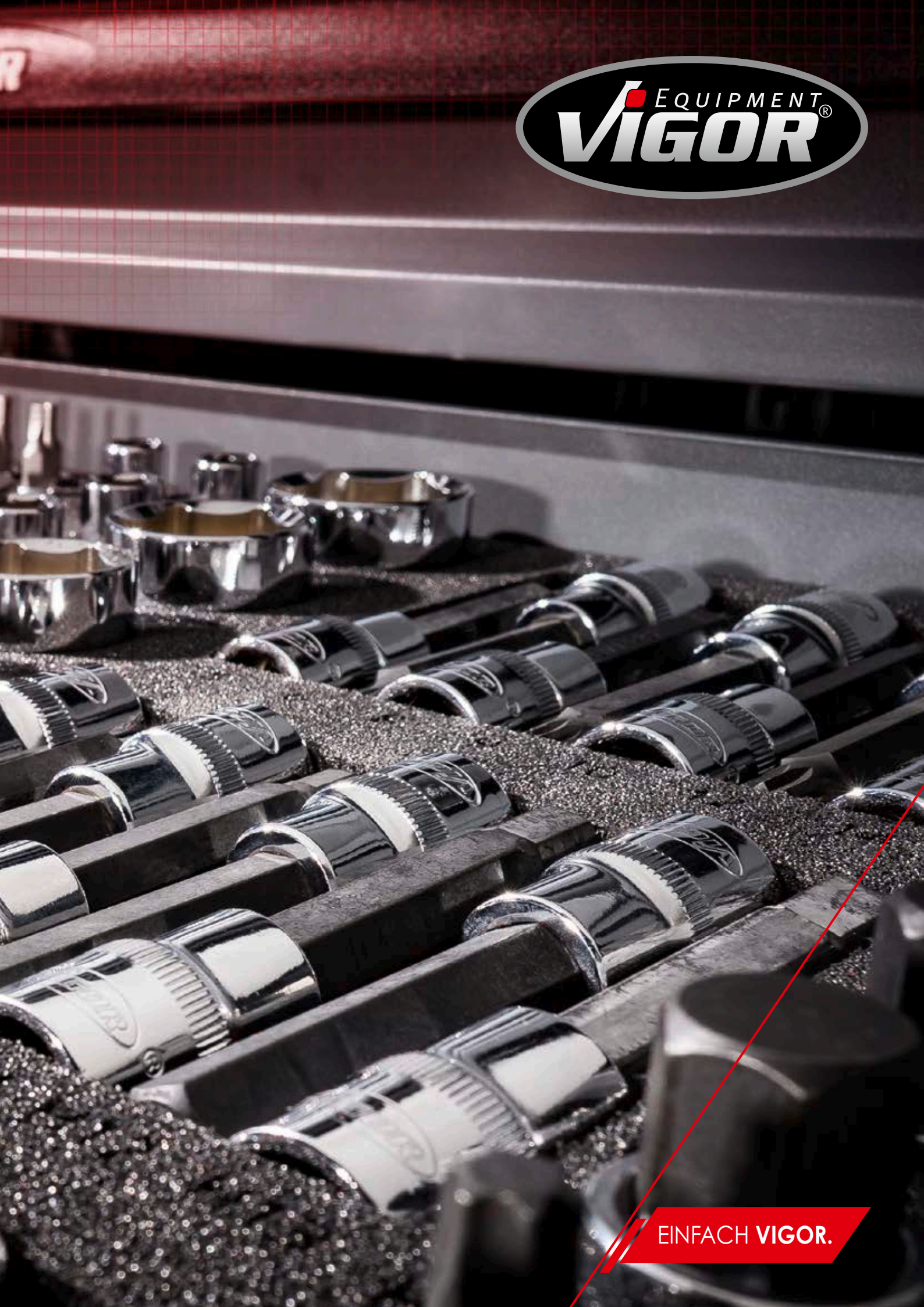

EINFACH VIGOR.

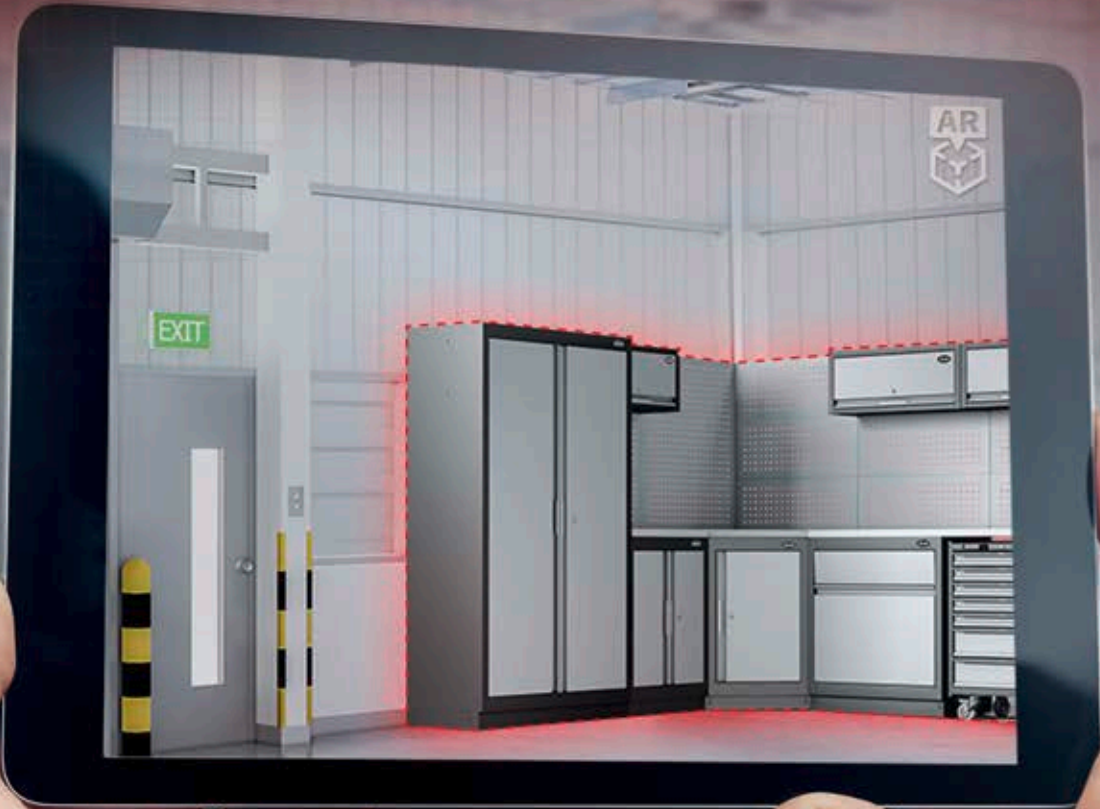

www.vigor-equipment.com/konfigurator

 **KONVIGORATOR**

Now with new functions!



Please contact us:

Copyright! 2024 by VIGOR GmbH

VIGOR GmbH · Am Langen Siepen 13-15 · D-42857 Remscheid · GERMANY info@vigor-equipment.com · www.vigor-equipment.com

Products available as long as stock lasts! All rights reserved regarding technical modifications. Figures may not always correspond to the original and are thus not binding! We accept no liability for printing errors!